





MINI FIT SR. WIRE TO BOARD & WIRE TO WIRE CONNECTOR SYSTEM

Female Terminal	Male Terminal
	
Series: 42815	Series: 42817

Receptacle (Single Row)	Plug (Single Row)
	
Series: 42816	Series: 42818

[Mini-Fit Sr. Power connectors Web Page](#)

[TABLE OF CONTENTS](#)

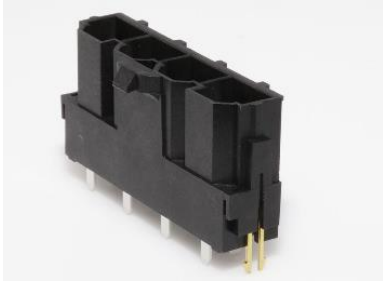
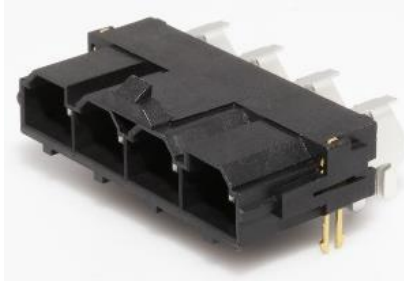

REVISION: E1	ECM INFORMATION: EC No: 658282 DATE: 2021/03/16	TITLE: PRODUCT SPECIFICATION FOR MINI-FIT SR CONNECTOR SYSTEM				SHEET No. 1 of 24
DOCUMENT NUMBER: PS-42815-001	DOC TYPE: PS	DOC PART: 001	CREATED / REVISED BY: KCHIKKANNA	CHECKED BY: KCHIKKANNA	APPROVED BY: ISHWARG	
<small>TEMPLATE FILENAME: 1703070003 REV A</small>						

Vertical Header (Single Row)	Right Angle Header (Single Row)
	
Series: 42819	Series: 42820

Vertical Header (Single Row Reflow capable)

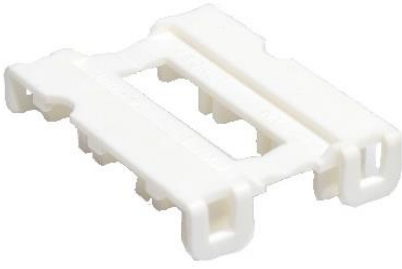
Series: 46986

Receptacle (Dual Row)	TPA (Dual Row)
	
Series: 43914	Series: 43980

[Mini-Fit Sr. Power connectors Web Page](#)

[TABLE OF CONTENTS](#)



REVISION: E1	ECM INFORMATION: EC No: 658282 DATE: 2021/03/16	TITLE: PRODUCT SPECIFICATION FOR MINI-FIT SR CONNECTOR SYSTEM				SHEET No. 2 of 24
DOCUMENT NUMBER: PS-42815-001	DOC TYPE: PS	DOC PART: 001	CREATED / REVISED BY: KCHIKKANNA	CHECKED BY: KCHIKKANNA	APPROVED BY: ISHWARG	
TEMPLATE FILENAME: 1703070003 REV A						

Vertical Header (Dual Row)	Panel Mount Plug (Dual Row)
	
Series: 43915	Series: 43938

Right Angle Header (Single Row)

Series: 46984

[Mini-Fit Sr. Power connectors Web Page](#)

[TABLE OF CONTENTS](#)



REVISION: E1	ECM INFORMATION: EC No: 658282 DATE: 2021/03/16	TITLE: PRODUCT SPECIFICATION FOR MINI-FIT SR CONNECTOR SYSTEM				SHEET No. 3 of 24
DOCUMENT NUMBER: PS-42815-001	DOC TYPE: PS	DOC PART: 001	CREATED / REVISED BY: KCHIKKANNA	CHECKED BY: KCHIKKANNA	APPROVED BY: ISHWARG	
TEMPLATE FILENAME: 1703070003 REV A						

Table of Contents

<u>ITEMS</u>	<u>PAGE</u>
1.0 SCOPE	5
2.0 PRODUCT DESCRIPTION	5
2.1 DESCRIPTION, SERIES NUMBER, AND LINKS	5
2.2 DIMENSIONS, MATERIALS, PLATINGS.....	5
2.3 ENVIRONMENTAL CONFORMANCE	5
2.4 SAFETY AGENCY LISTINGS	5
3.0 APPLICABLE DOCUMENTS AND SPECIFICATION	6
3.1 MOLEX DOCUMENTS	6
3.2 INDUSTRY DOCUMENTS	6
4.0 ELECTRICAL PERFORMANCE RATINGS	7
4.1 VOLTAGE AND SAFETY AGENCY RATINGS	7
4.2 MAXIMUM CURRENT RATING	7
4.3 TEMPERATURE.....	10
4.4 DURABILITY.....	10
5.0 QUALIFICATION	10
6.0 PERFORMANCE.....	11
6.1 ELECTRICAL PERFORMANCE.....	11
6.2 MECHANICAL PERFORMANCE	12
6.3 ENVIRONMENTAL PERFORMANCE.....	15
7.0 TEST SEQUENCE	17
8.0 SOLDER INFORMATION.....	19
8.1 SOLDER PROCESS TEMPERATURES *	19
8.2 SOLDERING PROFILE	19
9.0 PACKAGING	20
10.0 CABLE TIE AND / OR TWIST TIE LOCATION.....	21
11.0 POLARIZATION AND KEYING OPTIONS.....	22

[Mini-Fit Sr. Power connectors Web Page](#)

[TABLE OF CONTENTS](#)



REVISION: E1	ECM INFORMATION: EC No: 658282 DATE: 2021/03/16	TITLE: PRODUCT SPECIFICATION FOR MINI-FIT SR CONNECTOR SYSTEM				SHEET No. 4 of 24
DOCUMENT NUMBER: PS-42815-001	DOC TYPE: PS	DOC PART: 001	CREATED / REVISED BY: KCHIKKANNA	CHECKED BY: KCHIKKANNA	APPROVED BY: ISHWARG	
TEMPLATE FILENAME: 1703070003 REV A						

1.0 SCOPE

This Product Specification covers the 10.00 mm / (.394 in.) centerline tin and gold, silver plated connector series, single and dual row versions in wire to wire and wire to printed circuit board applications. This product performance is optimized for stranded tinned wire termination.

2.0 PRODUCT DESCRIPTION

2.1 DESCRIPTION, SERIES NUMBER, AND LINKS

DESCRIPTION	SERIES NUMBER
Female Terminal	42815
Male Terminal	42817
Receptacle (single row)	42816
Plug (single row)	42818
Vertical Header (single row)	42819
Right Angle Header (single row)	42820
Receptacle (dual row)	43914
TPA (dual row)	43980
Vertical Header (dual row)	43915
Panel mount Plug (dual row)	43938
Right Angle Header (single row, 260° C reflow capable (with gold and silver plating only))	46984
Vertical Header (single row, 260° C reflow capable (with gold and silver plating only))	46986

2.2 DIMENSIONS, MATERIALS, PLATINGS

See the appropriate sales drawings for the information on dimensions, materials, platings and markings.

2.3 ENVIRONMENTAL CONFORMANCE

To find product compliance information:

- [Go to molex.com](http://molex.com)
- Enter the part number in the search field.
- At the bottom of the page go to “Environmental” to see compliance status.

2.4 SAFETY AGENCY LISTINGS

UL File #E29179
IEC #61984:2008
CSA Certificate #LR 19980-555
TUV Certificate #R 72131193

[Mini-Fit Sr. Power connectors Web Page](#)

[TABLE OF CONTENTS](#)



REVISION: E1	ECM INFORMATION: EC No: 658282 DATE: 2021/03/16	TITLE: PRODUCT SPECIFICATION FOR MINI-FIT SR CONNECTOR SYSTEM	SHEET No. 5 of 24
DOCUMENT NUMBER: PS-42815-001	DOC TYPE: PS	DOC PART: 001	CREATED / REVISED BY: KCHIKKANNA
		CHECKED BY: KCHIKKANNA	APPROVED BY: ISHWARG
TEMPLATE FILENAME: 1703070003 REV A			

3.0 APPLICABLE DOCUMENTS AND SPECIFICATION

3.1 MOLEX DOCUMENTS

- [Mini-Fit Sr. Connectors Test summary TS-42815-001](#)
- [Mini-Fit Sr. Connectors Application Specification AS-42815-001](#)
- [Molex Quality Crimping Handbook Order No. 63800-0029](#)
- [Molex Solderability Specification SMES-152](#)
- [Molex Heat Resistance Specification AS-40000-5013](#)
- [Molex Moisture Technical Advisory AS-45499-001](#)
- [Molex Package Handling Specification 454990100-PK](#)
- ATS – Application Tooling Specification*

*Application Tooling Specification for terminals is not provided in this document. ATS for terminals can be available from respective terminal part number page in Molex.com

3.2 INDUSTRY DOCUMENTS

- EIA-364-1000
- UL-60950-1
- CSA STD. C22.2 NO. 182.3-M1987

[Mini-Fit Sr. Power connectors Web Page](#)

[TABLE OF CONTENTS](#)



REVISION: E1	ECM INFORMATION: EC No: 658282 DATE: 2021/03/16	TITLE: PRODUCT SPECIFICATION FOR MINI-FIT SR CONNECTOR SYSTEM				SHEET No. 6 of 24
DOCUMENT NUMBER: PS-42815-001	DOC TYPE: PS	DOC PART: 001	CREATED / REVISED BY: KCHIKKANNA	CHECKED BY: KCHIKKANNA	APPROVED BY: ISHWARG	
TEMPLATE FILENAME: 1703070003 REV A						

4.0 ELECTRICAL PERFORMANCE RATINGS

4.1 VOLTAGE AND SAFETY AGENCY RATINGS

600 Volts AC (RMS) or DC.

* This connector voltage meets the connector level provided by the safety agency. For application voltage requirements per UL-60950 or other standards, the creepage & clearance also needs to be determined based upon pads/traces on the PCB.

Series	Voltage (VAC (RMS) / VDC)			Current (A)				
	UL	CSA	TUV	UL	CSA		TUV	
				8*/14AWG	12 AWG	8*/10AWG	12AWG	10AWG
42818, 43914	600V	600V	600V	N/A	23A	30A	23A	33A
42816, 42819, 42820	600V	600V	250V	17A	23A	30A	23A	33A
43915	600V	600V	None	N/A	23A	30A	None	None
43938	None	600V	600V	N/A	23A	30A	23A	33A
46986	600V	600V	None	50A*	None	43A*	TBE	TBE

4.2 MAXIMUM CURRENT RATING

Molex rating is established based on MIL-W-5088 max. current capacity guidelines for copper conductors and test data summary TS-42815-001 section 5.3.7. Test data is based on 30 deg. C temperature rise using UL 1015 tinned stranded copper wire.

Single Row Product

	2ckt. W to W	2ckt. W to PCB**	4ckt. W to W	4ckt. W to PCB**	6ckt W to W	6ckt. W to PCB**
8 AWG	50A	48A	46A	44A	45A	37A
10 AWG	33A	33A	33A	33A	33A	33A
12 AWG	23A	23A	23A	23A	23A	23A
14 AWG	17A	17A	17A	17A	17A	17A
16 AWG	13A	13A	13A	13A	13A	13A

[Mini-Fit Sr. Power connectors Web Page](#)

[TABLE OF CONTENTS](#)



REVISION: E1	ECM INFORMATION: EC No: 658282 DATE: 2021/03/16	TITLE: PRODUCT SPECIFICATION FOR MINI-FIT SR CONNECTOR SYSTEM	SHEET No. 7 of 24
DOCUMENT NUMBER: PS-42815-001	DOC TYPE: PS	DOC PART: 001	CREATED / REVISED BY: KCHIKKANNA
		CHECKED BY: KCHIKKANNA	APPROVED BY: ISHWARG
TEMPLATE FILENAME: 1703070003 REV A			

	2ckt. W to W	2ckt. W to PCB**	4ckt. W to W	4ckt. W to PCB**	6ckt W to W	6ckt. W to PCB**
6mm ²	35A	-	-	-	-	-
5mm ²	35A	-	-	-	-	-

	2ckt. W to W	2ckt. W to PCB**	4ckt. W to W	4ckt. W to PCB**	6ckt W to W	6ckt. W to PCB**
12AWG Double Crimp	40A (20A per wire)	40A (20A per wire)	-	-	-	-

Dual Row Product

	6ckt. W to W	6ckt. W to PCB**	10ckt. W to W	10ckt. W to PCB**	14ckt W to W	14ckt. W to PCB**
8 AWG	43A	37A	40A	36.5A	38A	36A
10 AWG	32A	31A	31.5A	29.5A	29A	28A
12 AWG	23A	23A	23A	22.5A	23A	22A
14 AWG	17A	17A	17A	16.5A	17A	16A
16 AWG	13A	13A	13A	12.5A	13A	12A

**PCB trace design may greatly affect temperature rise results.

Ratings shown represent MAXIMUM current carrying capacity of a fully loaded connector with all circuits powered. Ratings are based on a 30°C maximum temperature rise limit over ambient (room temperature). Testing conducted with tinned copper conductor stranded wire. Above charts are intended as a guideline. Current rating is application dependent. Appropriate de-rating is required depending on factors such as higher ambient temperature, smaller copper weight of PCB traces, gross heating from adjacent modules or components and other factors that influence connector performance.

[Mini-Fit Sr. Power connectors Web Page](#)

[TABLE OF CONTENTS](#)



REVISION: E1	ECM INFORMATION: EC No: 658282 DATE: 2021/03/16	TITLE: PRODUCT SPECIFICATION FOR MINI-FIT SR CONNECTOR SYSTEM	SHEET No. 8 of 24
DOCUMENT NUMBER: PS-42815-001	DOC TYPE: PS	DOC PART: 001	CREATED / REVISED BY: KCHIKKANNA
		CHECKED BY: KCHIKKANNA	APPROVED BY: ISHWARG
TEMPLATE FILENAME: 1703070003 REV A			

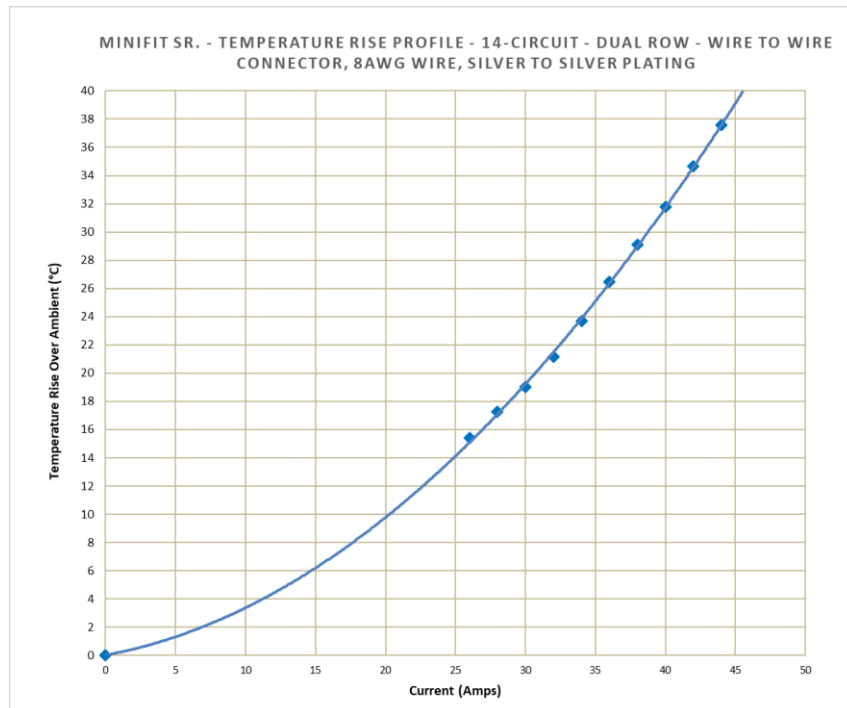
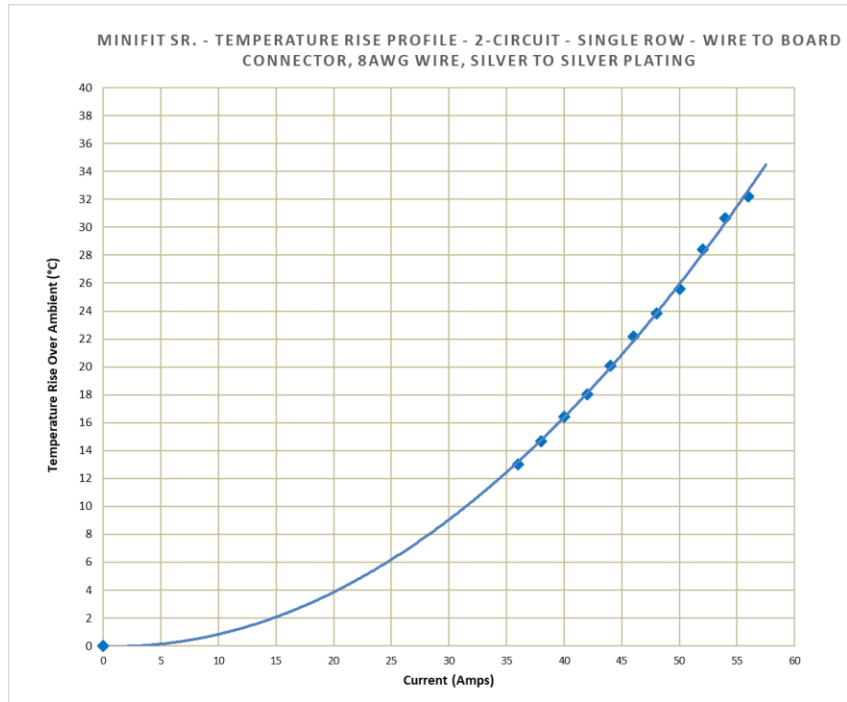

[Mini-Fit Sr. Power connectors Web Page](#)

[TABLE OF CONTENTS](#)



REVISION: E1	ECM INFORMATION: EC No: 658282 DATE: 2021/03/16	TITLE: PRODUCT SPECIFICATION FOR MINI-FIT SR CONNECTOR SYSTEM				SHEET No. 9 of 24
DOCUMENT NUMBER: PS-42815-001	DOC TYPE: PS	DOC PART: 001	CREATED / REVISED BY: KCHIKKANNA	CHECKED BY: KCHIKKANNA	APPROVED BY: ISHWARG	
TEMPLATE FILENAME: 1703070003 REV A						

4.3 TEMPERATURE

Operating: -40 Degrees C to +105 Degrees C
 Non-operating: -40 Degrees C to +105 Degrees C
 (Including 30 degrees C terminal temperature at full current)

4.4 DURABILITY

Plating Type	Number of Cycles
Tin Plated	30
Gold Plated	100
Silver Plated	30

*As tested in accordance with EIA-364-1000 test method (see section 6.2.12, 6.2.13 & 6.2.14 of this specification).
 Durability per EIA-364-09*

5.0 QUALIFICATION

Laboratory condition, sample selection and test sequences are in accordance with EIA-364-1000.

[Mini-Fit Sr. Power connectors Web Page](#)

[TABLE OF CONTENTS](#)



REVISION: E1	ECM INFORMATION: EC No: 658282 DATE: 2021/03/16	TITLE: PRODUCT SPECIFICATION FOR MINI-FIT SR CONNECTOR SYSTEM				SHEET No. 10 of 24
DOCUMENT NUMBER: PS-42815-001	DOC TYPE: PS	DOC PART: 001	CREATED / REVISED BY: KCHIKKANNA	CHECKED BY: KCHIKKANNA	APPROVED BY: ISHWARG	
TEMPLATE FILENAME: 1703070003 REV A						

6.0 PERFORMANCE

6.1 ELECTRICAL PERFORMANCE

ITEM	DESCRIPTION	TEST CONDITION	REQUIREMENT
6.1.1	Initial Contact Resistance (low level)	Mate connectors, measure by dry circuit, 20mV max., 100mA. Wire resistance shall be removed from the measured value.	1.5 mOhm max. (tin) 1.0 mOhm max. (gold) 1.5 mOhm max. (silver)
6.1.2	Insulation Resistance	Mate connectors, apply 500V DC between adjacent terminal or ground	1000 M Ohm min.
6.1.3	Dielectric Strength	Mate connectors, apply 2200V AC for 1 minute between adjacent terminal or ground.	No breakdown
6.1.4	Contact Resistance (rated)	Measure contact resistance at rated current.	1.5 mOhm max. (tin) 1.0 mOhm max. (gold) 1.5 mOhm max. (silver)
6.1.5	Contact Resistance on Crimp	Crimp the wire to the terminal, measure crimp resistance by dry circuit, 20mV max., 100mA	1.0 mOhm max.
6.1.6	W-T-W & W-T-B Temperature & Voltage drop profiling	Single Row: 2 CKT & 6 CKT	Max. temperature rise=30°C Per EIA 364 & CSA requirement
		Dual Row: 6 CKT & 14 CKT	

[Mini-Fit Sr. Power connectors Web Page](#)

[TABLE OF CONTENTS](#)



REVISION: E1	ECM INFORMATION: EC No: 658282 DATE: 2021/03/16	TITLE: PRODUCT SPECIFICATION FOR MINI-FIT SR CONNECTOR SYSTEM	SHEET No. 11 of 24
DOCUMENT NUMBER: PS-42815-001	DOC TYPE: PS	DOC PART: 001	CREATED / REVISED BY: KCHIKKANNA
		CHECKED BY: KCHIKKANNA	APPROVED BY: ISHWARG
TEMPLATE FILENAME: 1703070003 REV A			

6.2 MECHANICAL PERFORMANCE

ITEM	DESCRIPTION	TEST CONDITION	REQUIREMENT
6.2.1	Contact Insertion and Withdrawal	Insert and withdraw a contact at a speed rate of 25 +/- 6mm / minute	Max. Insertion = 29.42N Min. Withdrawal = 2.45N
6.2.2	Connector Insertion and Withdrawal	Insert and withdraw a connector at a rate of 25 +/- 6mm / minute	Max. Insertion = 29.42N/ckt. Min. Withdrawal = 2.45N/ckt.
6.2.3	Terminal Insertion Force	Insert the crimped terminal into the housing.	Max. Insertion = 68.64N
6.2.4	Crimp Terminal Retention Force	Apply axial pull out force at a speed rate of 25 +/- 6mm / minute on the terminal assembled in the housing and with the TPA cover installed.	Min. Retention = 98.00N
6.2.5	Header Terminal Retention Force	Apply axial pull out force at a speed rate of 25 +/- 6mm / minute on the terminal assembled in the housing.	Min. Retention = 19.60N
6.2.6	Wire Pull Out Force	Mount the crimped terminal, apply an axial pull out force on the wire at a speed rate of 25 +/- 6mm / minute.	16AWG = 137.30N 14AWG = 225.60N 12AWG = 304.00N 10AWG = 353.00N 8AWG = 392.30N
6.2.7	Normal Force	Apply a perpendicular force at a speed rate of 25 +/- 6mm minute	1.96N min.
6.2.8	PCB Insertion and Withdrawal Force	Apply force perpendicular to the housing at a speed rate of 25 +/- 6mm minute as shown.	Insertion = 19.00N max. Withdrawal = 9.80N min.
6.2.9	PCB Insertion and Withdrawal Force For 46986	Apply force perpendicular to the housing at a speed rate of 25 +/- 6mm minute as shown.	Insertion = 24.50N max. Withdrawal = 9.80N min.
6.2.10	Panel Insertion & Withdrawal	Insert and withdraw a connector at a speed rate of 25 +/- 6mm / minute	Insertion = 49.00N max. Withdrawal = 98.00N min.

[Mini-Fit Sr. Power connectors Web Page](#)

[TABLE OF CONTENTS](#)



REVISION: E1	ECM INFORMATION: EC No: 658282 DATE: 2021/03/16	TITLE: PRODUCT SPECIFICATION FOR MINI-FIT SR CONNECTOR SYSTEM	SHEET No. 12 of 24
DOCUMENT NUMBER: PS-42815-001	DOC TYPE: PS	DOC PART: 001	CREATED / REVISED BY: KCHIKKANNA
		CHECKED BY: KCHIKKANNA	APPROVED BY: ISHWARG
TEMPLATE FILENAME: 1703070003 REV A			

6.2 MECHANICAL PERFORMANCE (CONT.)			
ITEM	DESCRIPTION	TEST CONDITION	REQUIREMENT
6.2.11	Latch Yield Strength (only 43914 receptacle w/ 43938 plug)	Insert and withdraw connector housings (30 times) and pull apart at a speed rate of 25 +/- 6mm / minute	Yield = 68.64N min.
6.2.12	Latch Yield Strength (all other)	Insert and withdraw connector housings (30 times) and pull apart at a speed rate of 25 +/- 6mm / minute	Yield = 98.00N min.
6.2.13	Durability (tin)	Insert and withdraw connectors (30 times) at a maximum rate of 10 cycles per minute prior to environmental tests.	Contact Res. Change = 1.0mOhm max.
6.2.14	Durability (gold)	Insert and withdraw connectors (100 times) at a maximum rate of 10 cycles per minute prior to environmental tests.	Contact Res. change = 1.0mOhm max.
6.2.15	Durability (silver)	Insert and withdraw connectors (30 times) at a maximum rate of 10 cycles per minute prior to environmental tests.	Contact Res. Change = 1.0 mOhm max.
6.2.16	Vibration with lubrication (tin) (Nyogel 760G)	10-500HZ with a G Level of 10 Duration: 9 hours.	Contact Res change = 1.0mOhm max Discontinuity not greater than 1 microsecond
6.2.17	Vibration without lubrication (gold)	10-500HZ with a G Level of 10 Duration: 9 hours.	Contact Res change = 1.0mOhm max Discontinuity not greater than 1 microsecond
6.2.18	Vibration with lubrication (silver)	10-500HZ with a G Level of 10 Duration: 9 hours.	Contact Res change = 1.0 mOhm max Discontinuity not greater than 1 microsecond

[Mini-Fit Sr. Power connectors Web Page](#)

[TABLE OF CONTENTS](#)



REVISION: E1	ECM INFORMATION: EC No: 658282 DATE: 2021/03/16	TITLE: PRODUCT SPECIFICATION FOR MINI-FIT SR CONNECTOR SYSTEM	SHEET No. 13 of 24
DOCUMENT NUMBER: PS-42815-001	DOC TYPE: PS	DOC PART: 001	CREATED / REVISED BY: KCHIKKANNA
		CHECKED BY: KCHIKKANNA	APPROVED BY: ISHWARG
TEMPLATE FILENAME: 1703070003 REV A			

6.2 MECHANICAL PERFORMANCE (CONT.)

ITEM	DESCRIPTION	TEST CONDITION	REQUIREMENT
6.2.19	Mechanical Shock	50 G, 11ms, Half-Sine Shock Pulse.	Contact Res. change = 1.0mOhm max. Discontinuity not greater than 1 microsecond
6.2.20	TPA Insertion / Withdrawal force	Single Row 2CKT Plug housing, Plug housing dual row 14CKT	Max. Insertion = 500N Min. Withdrawal = 50 N
6.2.21	Finger Proof Test	Single row 6 CKT plug housing	Finger probe model-UL 1977 for Testing

UL 1977 Standard - Fingerprobe Testing - 6-Circuit - Wire-to-Wire			
Mode	Configuration	Sample	Result
A		Receptacle Housing 6CKT with TPA - Single Row Female Crimped Terminal 8 AWG Silver	PASS
B		Plug Housing 6CKT with TPA - Single Row Male Crimped Terminal 8 AWG Silver	FAIL
A+B		Receptacle Housing 6CKT with TPA - Single Row Female Crimped Terminal 8 AWG Silver Plug Housing 6CKT with TPA - Single Row Male Crimped Terminal 8 AWG Silver	PASS

Fig 6.2.21 Finger Proof Test

* NOTE: Thermal cycling, vibration and other factors can cause micro-motion within a mated connection. Micro-motion without lubricant could lead to fretting corrosion on tin plating. Due to the many factors that may be present in an application, Molex highly recommends the use of lubrication with Mini-Fit Sr tin-plated terminals for reliability assurance. See AS-42815-001 for more information

[Mini-Fit Sr. Power connectors Web Page](#)

[TABLE OF CONTENTS](#)



REVISION: E1	ECM INFORMATION: EC No: 658282 DATE: 2021/03/16	TITLE: PRODUCT SPECIFICATION FOR MINI-FIT SR CONNECTOR SYSTEM	SHEET No. 14 of 24
DOCUMENT NUMBER: PS-42815-001	DOC TYPE: PS	DOC PART: 001	CREATED / REVISED BY: KCHIKKANNA
		CHECKED BY: KCHIKKANNA	APPROVED BY: ISHWARG
TEMPLATE FILENAME: 1703070003 REV A			

6.3 ENVIRONMENTAL PERFORMANCE

ITEM	DESCRIPTION	TEST CONDITION	REQUIREMENT
6.3.1	Cold Resistance	-40 +/- 3 degrees C for 96 hrs.	Appearance: No damage Contact Res. change = 1.0mOhm max.
6.3.2	Thermal Shock	Mate connectors, expose to 25 cycles of: -40 +/- 3 deg. C for 30 minutes +25 +/- 10 deg. C for 5 minutes max. +105 +/- 3/-0 deg. C for 30 minutes +25 +/- 10 deg. C for 5 minutes max.	Appearance: No damage Contact Res. change = 1.0mOhm max.
6.3.3	Thermal Aging	Mate connectors, expose to 240 hours at 105 +/- 2 deg. C	Appearance: No damage Contact Res. change = 1.0mOhm max
6.3.4	Humidity (Steady State)	Mate connectors, expose to a temperature of 40 +/- 2 deg. C with a relative humidity of 90% to 95% for 96 hours.	Appearance: No damage Contact Res. change = 1.0mOhm max Dielectric withstanding voltage: No breakdown Insul. res: 1000M Ohm min.
6.3.5	Humidity (cyclic) (Tin and Gold Plated parts)	Mate connectors, expose to 25 cycles at 90% to 95% relative humidity with a transition time of 2.5 hrs. between extremes. +25 +/- 10 deg. C for 5 minutes max. +65 +/- 3/-0 deg. C for 30 minutes	Appearance: No damage Contact Res. change = 2.0mOhm max Dielectric withstanding voltage: No breakdown Insul. res: 1000M Ohm min.
6.3.6	Cyclic Temperature & Humidity- Silver	Mate connectors: cycle per EIA-36431: 24 cycles at temperature 25 ± 3°C at 80 ± 5% relative humidity and 65 ± 3°C at 50 ± 5% relative humidity; dwell time of 1.0 hour; ramp time of 0.5 hours.	Appearance: No damage Contact Res. change = 1.0 mOhm max Dielectric withstanding voltage: No breakdown Insul. res: 1000M Ohm min.
6.3.7	Immunity to Fretting Corrosion with lubrication. (tin) (Nyogel 760G)	Mate connectors, expose to 500 cycles with a max. transition time of 5 minutes between extremes. +25 +/- 10 deg. C for 30 minutes +70 +/- 3/-0 deg. C for 30 minutes	Appearance: No damage Contact Res. change = 1.0mOhm max

[Mini-Fit Sr. Power connectors Web Page](#)

[TABLE OF CONTENTS](#)



REVISION: E1	ECM INFORMATION: EC No: 658282 DATE: 2021/03/16	TITLE: PRODUCT SPECIFICATION FOR MINI-FIT SR CONNECTOR SYSTEM	SHEET No. 15 of 24
DOCUMENT NUMBER: PS-42815-001	DOC TYPE: PS	DOC PART: 001	CREATED / REVISED BY: KCHIKKANNA
		CHECKED BY: KCHIKKANNA	APPROVED BY: ISHWARG
TEMPLATE FILENAME: 1703070003 REV A			

6.3 ENVIRONMENTAL PERFORMANCE (CONT.)

ITEM	DESCRIPTION	TEST CONDITION	REQUIREMENT
6.3.8	Immunity to Fretting Corrosion with lubrication. Silver	Mate connectors, expose to 500 cycles with a max. transition time of 5 minutes between extremes. +15 +/- 3 deg. C for 30 minutes +85 +/-3 deg. C for 30 minutes	Appearance: No damage Contact Res. change = 1.0mOhm max
6.3.9	Temp. Rise & Current Cycling	Mate the connectors and measure the temperature rise at the rated current for 96 hrs., 45 minutes ON and 15 minutes OFF for 240 hrs., and an additional 96 hrs. of steady-state current.	Max. Temp. Rise = 30deg. C Per EIA 364 and CSA requirement
6.3.10	Solderability**	Per SMES-152	Solder coverage: 95% MINIMUM (per SMES-152)
6.3.11	Reflow Solder Heat Resistance	Reflow solder process: 235°C max per AS-40000-5013	Appearance: No damage Dimensional: Conformance to sales drawing requirements.
6.3.12	Reflow Solder Heat Resistance: applicable to 46984 & 46986 with gold & Silver plating ONLY	Reflow solder process: 260°C max per AS-40000-5013	Appearance: No damage Dimensional: Conformance to sales drawing requirements.
6.3.13	Wave Solder Heat Resistance **	Dip header terminal tails in solder: Solder Duration: 3 +/- 0.5 seconds Solder Temperature.: 260 +/- 5 deg. C Per AS-40000-5013	Appearance: No damage
6.3.14	Resistance to Solvents	Solvent: flourinert FC-70 (3M Corp.) Solvent temp: Boiling temp. Immersion time: 120 +/- 5 seconds Solvent: Alpha 1003 (Alpha Metal) Solvent: Isopropyl Alcohol Solvent Temp.: Boiling temp. Immersion time: 240 +/- 5 seconds Repeat in solvent 5 times. Rinse with deionized water between cycles.	Appearance: No damage

****NOTE:** This product is compatible with lead-free hand soldering temperatures. Always mate header to receptacle or plug to receptacle only with like metal plating option. (Ex: Silver- Silver, Gold to Gold and Tin-Tin)

[Mini-Fit Sr. Power connectors Web Page](#)

[TABLE OF CONTENTS](#)



REVISION: E1	ECM INFORMATION: EC No: 658282 DATE: 2021/03/16	TITLE: PRODUCT SPECIFICATION FOR MINI-FIT SR CONNECTOR SYSTEM	SHEET No. 16 of 24
DOCUMENT NUMBER: PS-42815-001	DOC TYPE: PS	DOC PART: 001	CREATED / REVISED BY: KCHIKKANNA
		CHECKED BY: KCHIKKANNA	APPROVED BY: ISHWARG
TEMPLATE FILENAME: 1703070003 REV A			

7.0 TEST SEQUENCE

Reliability Test Sequences Per EIA-364-1000

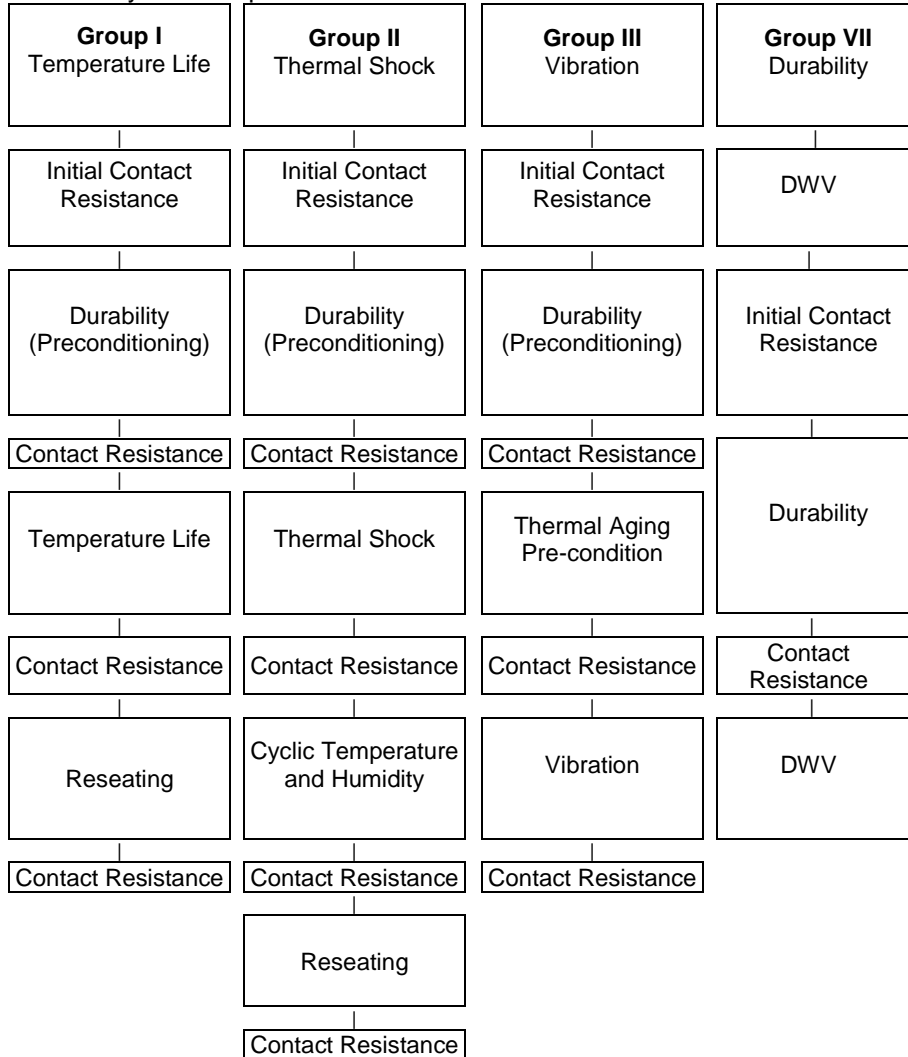

[Mini-Fit Sr. Power connectors Web Page](#)

[TABLE OF CONTENTS](#)



REVISION: E1	ECM INFORMATION: EC No: 658282 DATE: 2021/03/16	TITLE: PRODUCT SPECIFICATION FOR MINI-FIT SR CONNECTOR SYSTEM	SHEET No. 17 of 24
DOCUMENT NUMBER: PS-42815-001	DOC TYPE: PS	DOC PART: 001	CREATED / REVISED BY: KCHIKKANNA
		CHECKED BY: KCHIKKANNA	APPROVED BY: ISHWARG
TEMPLATE FILENAME: 1703070003 REV A			

Individual Tests

Contact
Insertion / withdrawal Force

Connector
Mating / Unmating Force

Terminal Insertion force

Terminal Retention force

Header Terminal Retention
force

Wire Pullout force (Axial)

Normal force

PCB Insertion & Withdrawal
Force

Panel insertion & withdrawal

Latch Yield strength

Temperature
Rise

T-Rise Profiling

Steady State
Temperature
Rise

[Mini-Fit Sr. Power connectors Web Page](#)

[TABLE OF CONTENTS](#)



REVISION: E1	ECM INFORMATION: EC No: 658282 DATE: 2021/03/16	TITLE: PRODUCT SPECIFICATION FOR MINI-FIT SR CONNECTOR SYSTEM				SHEET No. 18 of 24
DOCUMENT NUMBER: PS-42815-001	DOC TYPE: PS	DOC PART: 001	CREATED / REVISED BY: KCHIKKANNA	CHECKED BY: KCHIKKANNA	APPROVED BY: ISHWARG	
TEMPLATE FILENAME: 1703070003 REV A						

8.0 SOLDER INFORMATION

Per SMES-152 and AS-40000-5013

*These specifications establish standard solderability test methods used to evaluate a products ability to accept molten solder. Solder Process Temperatures and Reflow Solder Profiles will vary based on application, equipment, solder paste, PCB thickness, etc.

8.1 SOLDER PROCESS TEMPERATURES *

Wave Solder Temperature: 245°C Maximum
 Reflow Solder Temperature: 260°C Maximum

[Molex Solderability Specification](#)

[SMES-152](#)
 (Click Here)

8.2 SOLDERING PROFILE

(This profile is per AS-40000-5013 and is provided as a guideline only. Please see notes for additional information)

[Molex Connector Heat Resistance Specification AS-40000-5013](#)
 (Click Here)

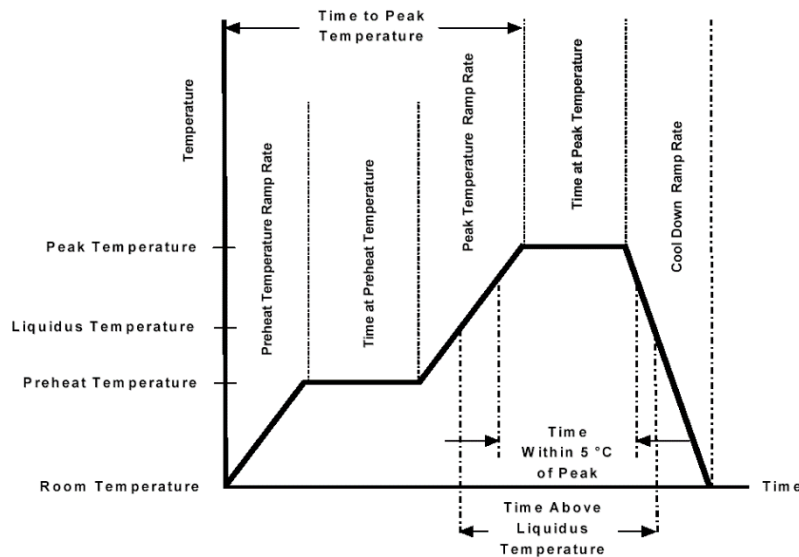

[Mini-Fit Sr. Power connectors Web Page](#)

[TABLE OF CONTENTS](#)



REVISION: E1	ECM INFORMATION: EC No: 658282 DATE: 2021/03/16	TITLE: PRODUCT SPECIFICATION FOR MINI-FIT SR CONNECTOR SYSTEM	SHEET No. 19 of 24
DOCUMENT NUMBER: PS-42815-001	DOC TYPE: PS	DOC PART: 001	CREATED / REVISED BY: KCHIKKANNA
		CHECKED BY: KCHIKKANNA	APPROVED BY: ISHWARG
TEMPLATE FILENAME: 1703070003 REV A			

Description	Requirement
Average Ramp Rate	3°C/sec Max
Preheat Temperature	150°C Min to 200°C Max
Preheat Time	60 to 180 sec
Ramp to Peak	3°C/sec Max
Time over Liquidus (217°C)	60 to 150 sec
Peak Temperature	260 +0/-5°C
Time within 5°C of Peak	20 to 40 sec
Ramp - Cool Down	6°C/sec Max
Time 25°C to Peak	8 min Max

Notes:

1. Temperature indicated refers to the PCB surface temperature at solder tail area.
2. Connector can withstand 3 reflow cycle.
3. Actual reflow profile also depends on equipment, solder paste, PCB thickness, and other components on the board. Please consult your solder paste & reflow equipment manufacturer for their recommendations to adopt a suitable process.

9.0 PACKAGING

Parts shall be packaging to protect the parts from damage during standard shipping, storage, and handling. Refer Molex.com specific part number webpage to get the exact packaging document for that item.

[Mini-Fit Sr. Power connectors Web Page](#)

[TABLE OF CONTENTS](#)



REVISION: E1	ECM INFORMATION: EC No: 658282 DATE: 2021/03/16	TITLE: PRODUCT SPECIFICATION FOR MINI-FIT SR CONNECTOR SYSTEM				SHEET No. 20 of 24
DOCUMENT NUMBER: PS-42815-001	DOC TYPE: PS	DOC PART: 001	CREATED / REVISED BY: KCHIKKANNA	CHECKED BY: KCHIKKANNA	APPROVED BY: ISHWARG	
TEMPLATE FILENAME: 1703070003 REV A						

10.0 CABLE TIE AND / OR TWIST TIE LOCATION

Circuit Sizes			Dimension T Minimum
2, 3	4, 5	6	0.50" (12.7mm)
8			0.75" (19.1mm)
10	12		1.00" (25.40mm)
14			1.25" (31.75mm)

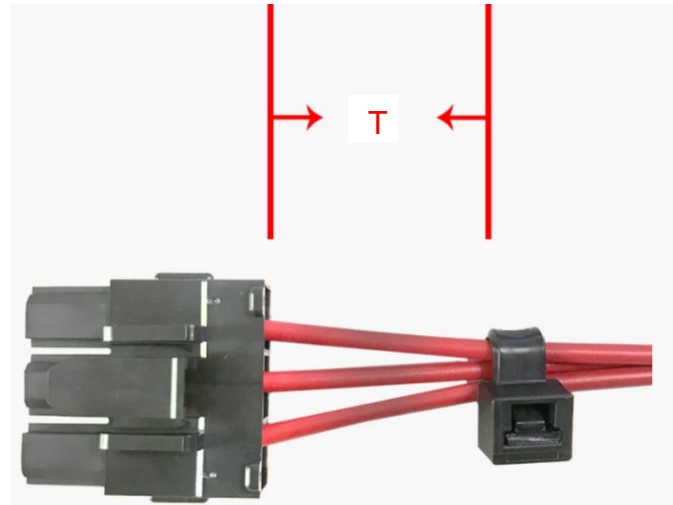

The "T" dimension defines a "free" length of wire, or a length of wire that is not subject to significant bias by external factors such as a wire tie, wire twisting, or other means of bending or deforming of the wires that repositions them from their natural relaxed state or location where they enter the housing. Wires are to be dressed in such a manner to allow the terminals to float freely in the pocket. This dimension is general recommendation and may need to be adjusted for different wire gauges and wire type and insulation thickness and insulation material.

[Mini-Fit Sr. Power connectors Web Page](#)

[TABLE OF CONTENTS](#)



REVISION: E1	ECM INFORMATION: EC No: 658282 DATE: 2021/03/16	TITLE: PRODUCT SPECIFICATION FOR MINI-FIT SR CONNECTOR SYSTEM	SHEET No. 21 of 24
DOCUMENT NUMBER: PS-42815-001	DOC TYPE: PS	DOC PART: 001	CREATED / REVISED BY: KCHIKKANNA
		CHECKED BY: KCHIKKANNA	APPROVED BY: ISHWARG
TEMPLATE FILENAME: 1703070003 REV A			

11.0 POLARIZATION AND KEYING OPTIONS

11.1 Receptacle (Series: [42816](#))

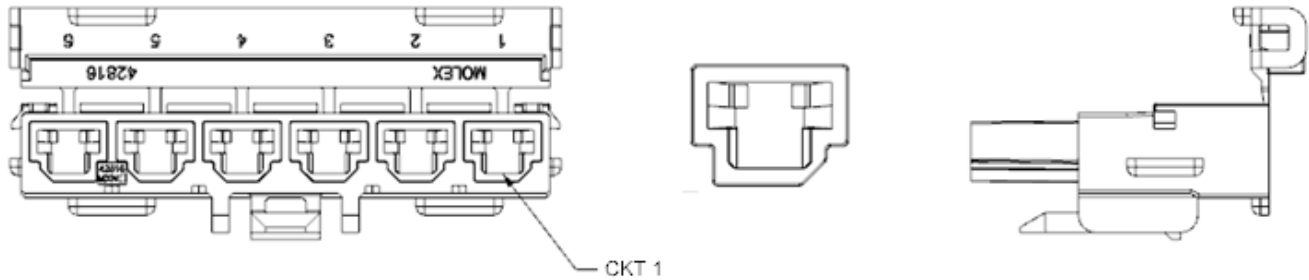

11.2 Plug (Single Row) (Series: [42818](#))

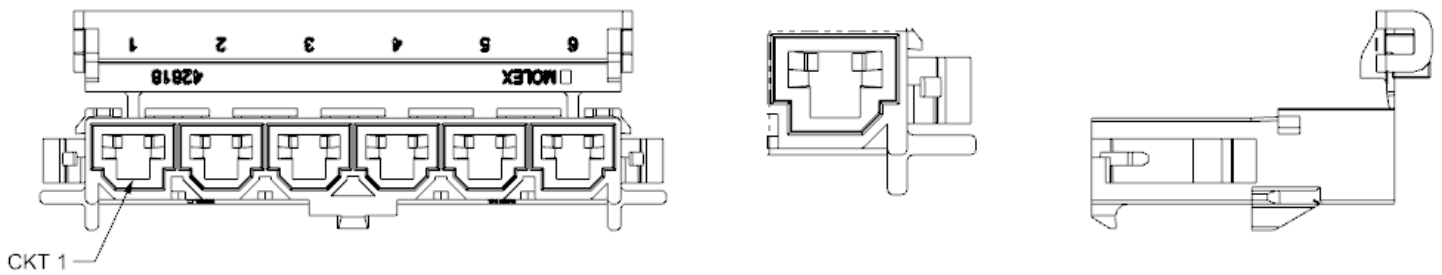

11.3 Vertical Header (Single row) (Series: [42819](#))

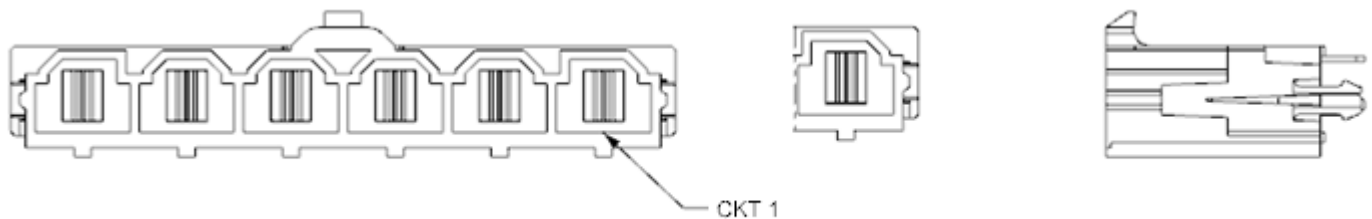

[Mini-Fit Sr. Power connectors Web Page](#)

[TABLE OF CONTENTS](#)



REVISION: E1	ECM INFORMATION: EC No: 658282 DATE: 2021/03/16	TITLE: PRODUCT SPECIFICATION FOR MINI-FIT SR CONNECTOR SYSTEM	SHEET No. 22 of 24
DOCUMENT NUMBER: PS-42815-001	DOC TYPE: PS	DOC PART: 001	CREATED / REVISED BY: KCHIKKANNA
		CHECKED BY: KCHIKKANNA	APPROVED BY: ISHWARG
TEMPLATE FILENAME: 1703070003 REV A			

11.4 Right Angle Header (Single Row) (Series: [42820](#))

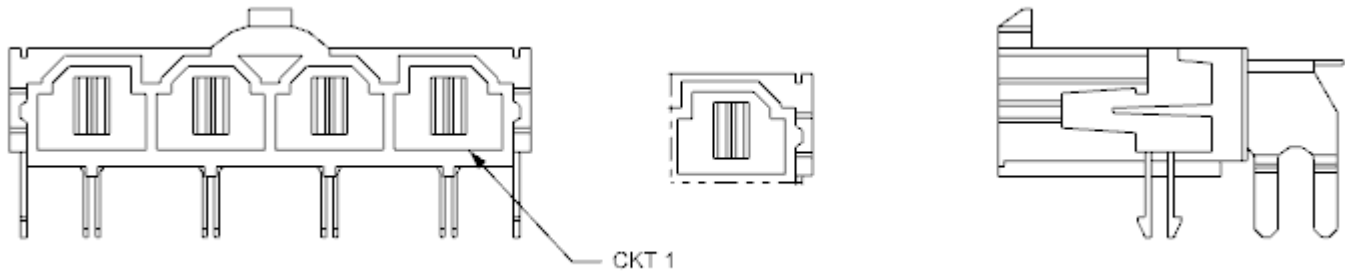

11.5 Receptacle (Dual Row) (Series: [43914](#))

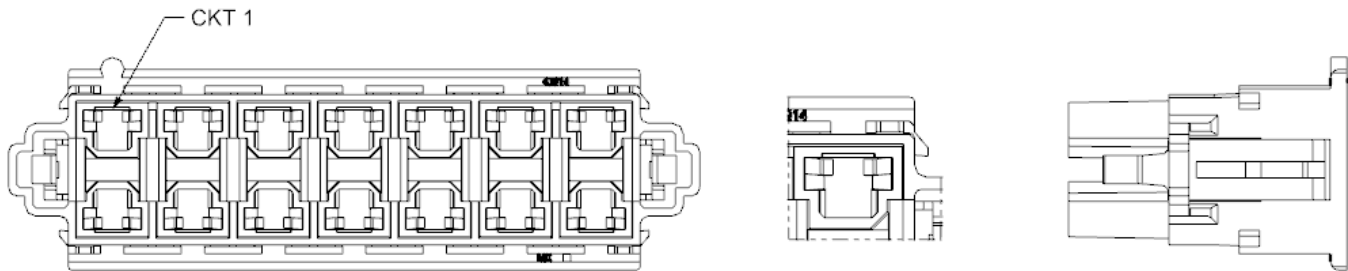

11.6 Vertical Header (Dual Row) (Series: [43915](#))

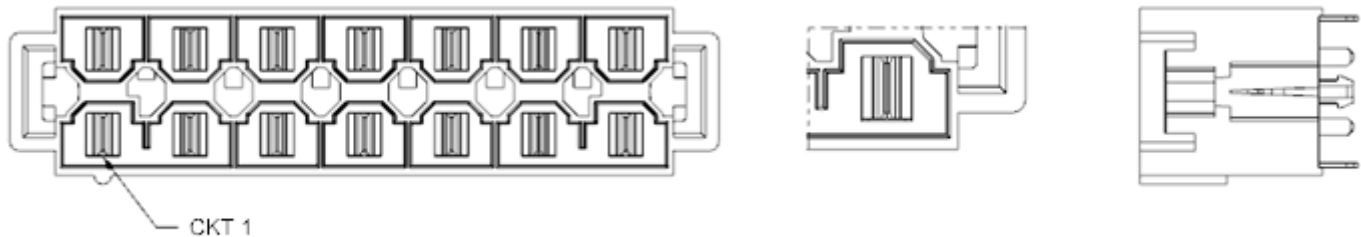

[Mini-Fit Sr. Power connectors Web Page](#)

[TABLE OF CONTENTS](#)



REVISION: E1	ECM INFORMATION: EC No: 658282 DATE: 2021/03/16	TITLE: PRODUCT SPECIFICATION FOR MINI-FIT SR CONNECTOR SYSTEM	SHEET No. 23 of 24
DOCUMENT NUMBER: PS-42815-001	DOC TYPE: PS	DOC PART: 001	CREATED / REVISED BY: KCHIKKANNA
		CHECKED BY: KCHIKKANNA	APPROVED BY: ISHWARG
TEMPLATE FILENAME: 1703070003 REV A			

11.7 Panel Mount Plug (Dual Row) (Series: [43938](#))

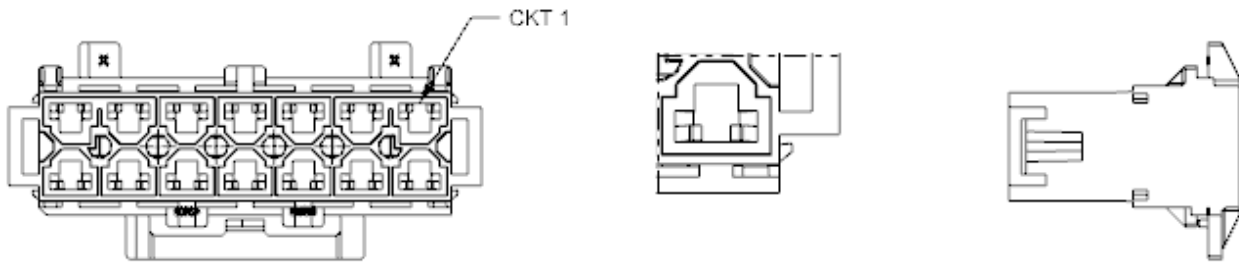

11.8 Right Angle Header (Single Row) (Series: [46984](#))

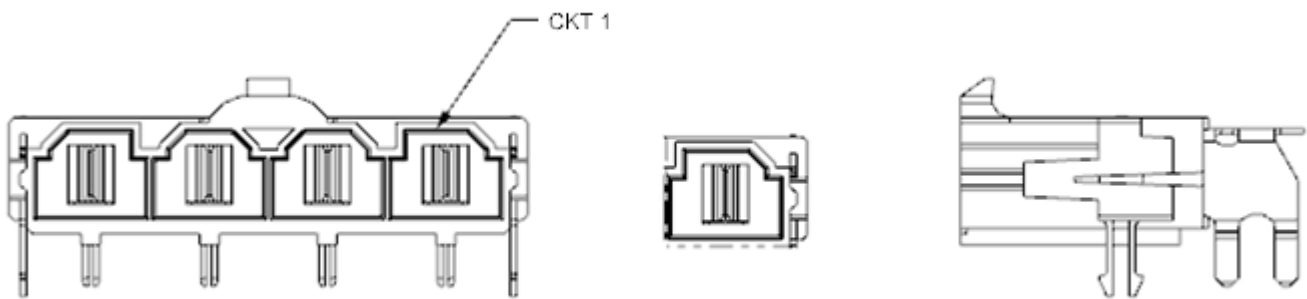

[Mini-Fit Sr. Power connectors Web Page](#)

[TABLE OF CONTENTS](#)



REVISION: E1	ECM INFORMATION: EC No: 658282 DATE: 2021/03/16	TITLE: PRODUCT SPECIFICATION FOR MINI-FIT SR CONNECTOR SYSTEM	SHEET No. 24 of 24
DOCUMENT NUMBER: PS-42815-001	DOC TYPE: PS	DOC PART: 001	CREATED / REVISED BY: KCHIKKANNA
		CHECKED BY: KCHIKKANNA	APPROVED BY: ISHWARG
TEMPLATE FILENAME: 1703070003 REV A			