



Suburban
Manufacturing Company

PRODUCT PRESENTATION

RV FURNACES

*The
Dynatrail
Line*

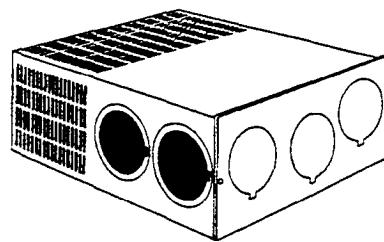
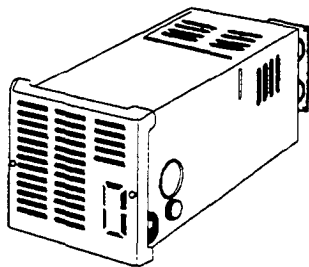
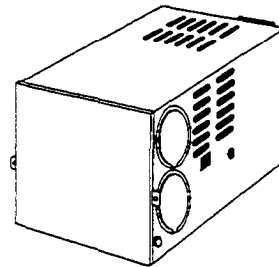

FURNACE SPECIFICATIONS

Model	Input BTU/hr	Type Gas	Electrical	Amp Draw	Static Pressure	C.F.M. Average
DD12P	12,000	Propane	12 VDC	2.8	n/a	145
DD17P	17,000	Propane	12 VDC	2.8	n/a	145
DD17DSI	17,000	Propane	12 VDC	2.8	n/a	145
NT12S/SE	12,000	Propane	12 VDC	2.9	SE - n/a S - .1" wc	SE -140 S - 122
NT16S/SE	16,000	Propane	12 VDC	2.9	SE - n/a S - .1" wc	SE-140 S - 165
NT20S/SE	20,000	Propane	12 VDC	2.9	SE - n/a S - .1" wc	SE-150 S - 165
NT24SP	24,000	Propane	12 VDC	3.5	.2" wc	265
NT30SP	30,000	Propane	12 VDC	5.5	.2" wc	345
NT34SP	34,000	Propane	12 VDC	7.5	.1" wc	373
NT40	40,000	Propane	12 VDC	9.0	.155"/.20B	441
NT45S	45,000	Propane	12 VDC	9.0	.2" wc	400
NT25K	25,000	Propane	12 VDC	6.5	.25" wc	365
NT30K	30,000	Propane	12 VDC	6.5	.2" wc	365
NT35K	35,000	Propane	12 VDC	6.5	.2" wc	380
SF20/F	20,000	Propane	12 VDC	4.5	.2" wc	300
SF25/F	25,000	Propane	12 VDC	6.5	.2" wc	300
SF30/F	30,000	Propane	12 VDC	6.5	.2" wc	300
SF35/F	35,000	Propane	12 VDC	8.5	.2" wc	375
SF42/F	42,000	Propane	12 VDC	11.5	.25" wc	430
P30S*	30,000	Propane	115 VAC	1.5	.15" wc	345
P40**	40,000	Propane	115 VAC	1.5	.15" wc	441
P45S*	45,000	Propane	115 VAC	1.5	.2" wc	400

* Park Model Furnace

** Park Model Furnace and valve is convertible to Natural Gas. See Manual for Instructions.

SEQUENCE OF OPERATION

The thermostat controls the operating circuit to the furnace by reacting to room temperature to open and close a set of contact points which allows current to flow to the ON and OFF switch then to the relay.

The relay receives the current and allows to pass through to the switch within the relay. This is done by a heater coil within the relay which actuates a bi-metal disc closing the relay circuit.

The current then flows to the motor and allows the blower to operate. One end of the motor shaft drives the room air wheel and the other end of the motor shaft drives the Combustion air wheel that delivers the required air to the burner for combustion.

As the room air wheel comes up to speed, air flow closes the sail switch completing the circuit. The sail switch is placed into the system as a safety to prove there is adequate air for combustion.

The limit switch is an in-line device which protects the furnace from any over heating conditions. The contacts in the limit switch open at a given temperature setting, shutting off power to the ignition system which controls the gas valve.

The next operation is controlled by the Direct Spark Ignition system as power is applied to the DSI board. The system will do the following.

1. The board has a timing circuit which allows the blower to purge the chamber of any products of combustion or gas.
2. The board will then apply current to the gas valve. At the same time it produces a high voltage current supply to the electrode producing spark at the burner.
3. The board will also confirm the presence of a flame. If the flame is not sensed after 6.8 seconds, the module will try two (2) more times and then go into lock-out. The flame is sensed through the spark wire and electrode.

When the thermostat has reached the set point with the room air temperature, the contacts will open removing power from the controls. The blower will remain on until the relay opens and stops the motor.

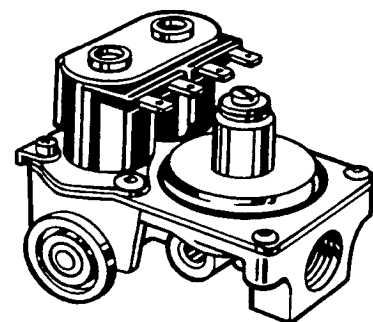
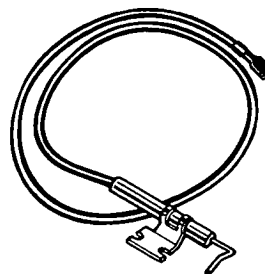
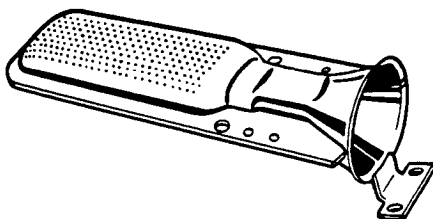
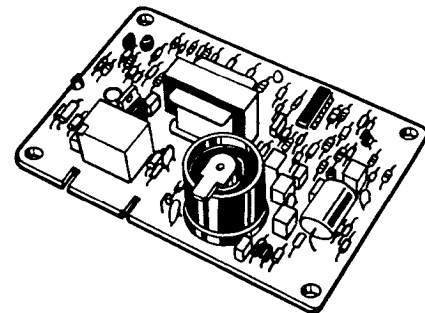
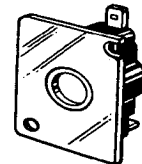
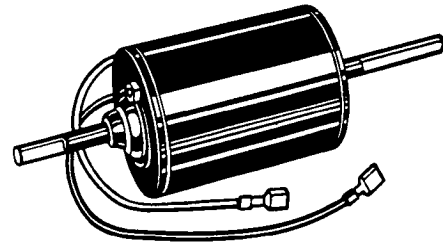
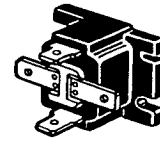
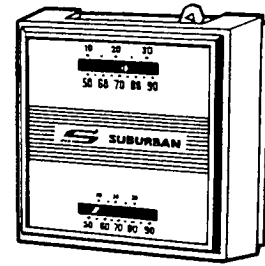

THE THERMOSTAT

There are many different types of thermostats being used in RV's today, everything from our standard thermostat to all types of electronic and setback units.

The first test of a thermostat is to make sure we have a full 12vdc power supply to the thermostat. Then after we have determined this we must then check the output of the thermostat. There are several reasons we may not have a good output, in most electronic circuits there is a natural voltage drop, usually about .5vdc. There is also a small drop in the voltage output of our module boards. If we get too many drops there will not be enough power to open the gas valve.

Here are some of the possibilities for a drop in the voltage; the thermostat wire may be too small and or too long, a high amp draw of a motor causing a loss of power, the wire size to the furnace is too small, weak converter output, as you can see the list can go on and on. The key is once you have found a drop in power, trace it back until you have found the source of the loss and correct the problem.

Remember, the thermostat controls the operating components of the furnace and depends on the power output of the thermostat, or control center. If this voltage is too low the furnace components will not operate correctly.

The anticipator on our thermostats set at .7 for a model 1985 and higher with a redundant gas valve. All the models with the single solenoid valve before 1985 will set at .5.

TEST THE AMP DRAW OF THE THERMOSTAT CIRCUIT

In order to find out if the controls of the furnace are operating at standard we must check the amp draw.

A customer comes to your shop with an anticipator burned or a blown fuse on the thermostat, the first thing is not to pull the furnace, but take your amp meter to the thermostat connection. The first component to draw amperage is the delay relay, it will spike out at 1.2 amps and slowly drop down to .2 amps. Then while still jumping out the thermostat the motor will began to run,

fifteen seconds later the valve will then open, this will add another .5 amps to the load for a total of .7 amps. This is why we set our anticipator at .7.

The electronic thermostat without an anticipator setting will have a preprogramed anticipation already built into the thermostat unit, for these no setting is necessary.

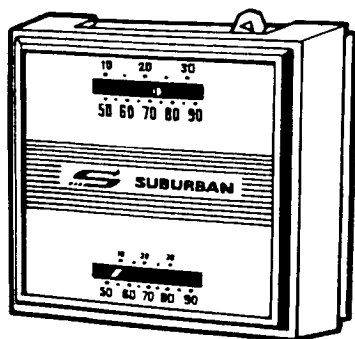

THE DELAY RELAY AND MOTOR

Measuring blower motor amps reveals another piece to the puzzle of understanding airflow and how it affects furnace operation.

The delay relay is a normally open switch, when power is applied to the relay from the thermostat a small heater warms a bi-metal on the contacts, after it warms the contacts close and the motor will begin to run. Remember you can check the amp draw from the thermostat connection. (see The Thermostat)

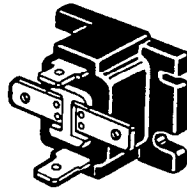

Your customer is suffering from low air flow and cycling on the limit switch, it's your job to figure out why and how to correct it. A quick and easy way to accomplish this is by the amp draw of the blower motor.

Amp draw is a measurement of the work load the blower is going through while its moving air. The amount of power consumed is measured in amp draw, amperage, or current. This gives us a peek at what is happening to the air flow.

Before measuring amp draw you need to know the amp load rating of each of our motors.

If the measured amp draw exceeds the motor's full load rating the motor is or will be failing. Excessive heat is what usually causes damage to motors and shortens life expectancy.

If the amp draw is low you have a serious flow problem and will need to change the motor.

Test Instruments

Most of us carry at least one multi meter that allows us to test

electrical properties. On these meters is a selection for DC amps that allows for a range up to 10 amps. This is usually enough to test an RV furnace motor. Remember to test DC amps you will need to swap the meter leads on 99% of all meters, note 10 DC amps.

HOW MUCH DOES AIR WEIGH?

If an empty bucket is sitting on a scale, does the air in the bucket effect the weight of the bucket? No. Because we take for granted in our measurements that the weight of the air is present; the weight of air is a constant.

Would the bucket weigh less if there was no air in the bucket? Yes. Because air weighs .075 lbs. per cubic foot. That is "Standard Air" at 70F at sea level and at 50% humidity.

It's the weight of air that drives the power consumption of a blower motor. If a fan operated in a vacuum or outer space would the amp draw be

less? Yes.

How much work does a blower motor use when it moves air? Let's look and see, If a SF 30 moves 300 cfm, you multiply 300 by .075 which comes out to 22.50 lbs of air per min.

Therefore the fan moves 22.50 X 60 min. = 1,350 lbs of air per hour.

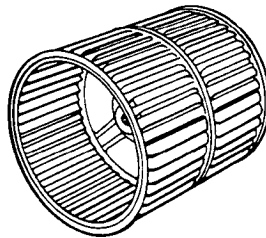
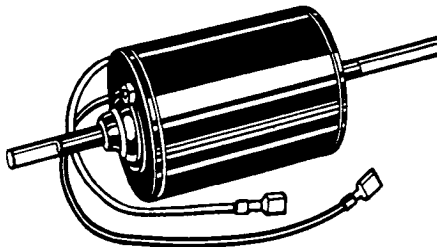

THE MODULE BOARD AND ELECTRODE

The electronic ignition system is made up of three main parts; the module board, the electrode assembly and the electrode wire. The module board is the brain of the system and it has several functions.

1. When the blower reaches approximately 75% of the normal r.p.m.

and sufficient air flow is established, the sail switch engages and completes a 12 volt circuit through the limit switch to the module board. (Note a low voltage power supply will not allow the motor to gain sufficient r.p.m.'s to engage the sail switch.)

2. After a 12-18 second delay the module will create a high voltage spark and send 12vdc to the valve simultaneously. This allows gas to flow through the burner and ignite the flame, once the flame touches the electrode assembly it will create a circuit through the flames to ground. This process is called "Flame Ionization".

HOW DOES FLAME SENSE REALLY WORK?

3. The micro amp signal is established through Flame Ionization. The electronic flame rectification of flame sense is accomplished by this process. Ionization systems rely on the burning of gases to complete a circuit, burning fuel gases conduct DC electricity because combustion releases electrons from the molecules of air and gas, this chemical process results in a surplus of positively charged particles called positive ions.

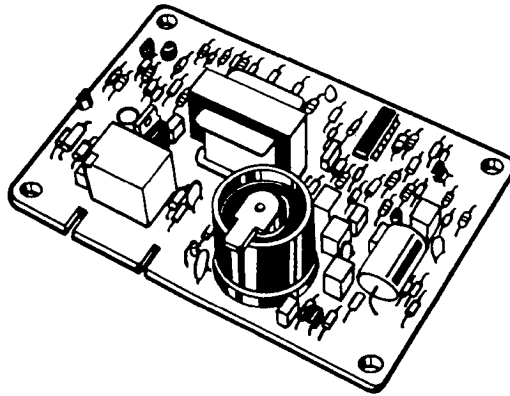

When the electrodes are placed in a flame, the negative charged electrodes repels electrons through the ionized gases, while the positively charged electrodes attracts the electrons. For this reason a circuit is established through the flames, as long as

there is a flame present, the circuit remains complete.

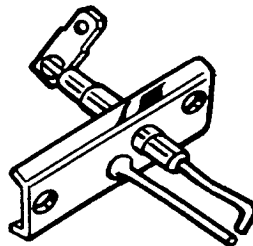

4. The module board also performs the lockout function in cases where the spark fails to light the burner. When lockout occurs, the spark stops, the voltage from the module board to the gas valve is discontinued, and the valve closes. The unit will remain in lockout and the

blower will continue to run until the thermostat is turned off. By cutting the power to the furnace and re-setting the thermostat reset the module to try to fire again. All of the boards we presently use are all three try modules, in other words it will try three times for ignition before it goes into lockout.

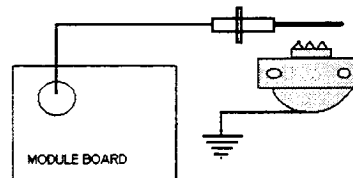

THE MICRO SWITCH AND THE LIMIT SWITCH

The micro switch or "sail switch" as we call it gets its name because of the air movement pushing the arm and closing the switch. The switch is a normally open switch and is closed when the motor reaches approximately 75-80% of its maximum air flow. This is provided by the room air wheel, since there is only one motor which provides both room and combustion air we can determine the velocity of the motor. The sail switch is a safety device which determines if the furnace is providing adequate combustion air for the furnace to operate.

The 80% mark of the motor is at a voltage of approximately 9.5vdc, if the input voltage is less than this the switch should not close. This is the reason it is very important to always use the correct switch for your furnace, **NEVER SUBSTITUTE SAIL SWITCHES.**

On some models you may find that the switch arm doesn't have a small paddle on the end of the arm shaft. These are designed without a paddle due to mounting and blower wheel clearances. Some have longer arm shafts than others depending on the gram pressure it takes to close the switch. (Also never alter a sail switch to make it fit, this is not a safe alternative.) Always use a genuine Suburban replacement part.

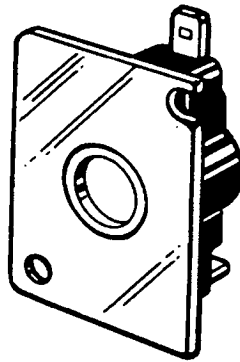

The limit switch is what it says, it limits the furnace from getting too hot, or over heating. A furnace that is getting too hot is not operating in a safe manner and may be caused by several different conditions. We will go into details about this in "Installations".

The limit switch is a normally closed switch and will open at a specified temperature of each switch. Every furnace we build has a different temperature limit device for each model and BTU rating.

AND AGAIN, NEVER SUBSTITUTE LIMIT SWITCHES.

The sail switch and the limit switch in sequence with each other allows power to be fed to the module board, once the thermostat calls for heat. While troubleshooting the furnace always make sure the module has power through these switches. Be sure the switch you replace is the correct temperature and size to insure the furnace is always operating as safe as possible.



THE VALVE AND BURNER

The valve and burners are the heart of combustion for your furnace, together they control the manifold pressure and the amount of gas to be burned. Without a clean burn the furnace can produce hazardous gases that could be very dangerous. This is why we must make sure the burner has a sharp hard blue flame with little to no yellow at the tip. On pre 1985 furnace models may have a cast iron burner, these will need to have the air shutter adjusted when cleaned or serviced. It's important to remember the cast iron will rust more frequently and will need to be cleaned more often than other type burner materials. When cleaning the cast iron burner be sure not to enlarge the burner slots. This burner may have been cleaned several times in its life.

Suburban uses many different types of burners, stainless punch port, aluminized punch port, stainless ribbon, and in the past cast iron. The one thing all these have in common; they all use the same type combustion, sealed force draft. They all look different but all work the same.

Over the years we have used many different valves also, pre 1985 furnaces have a single solenoid valve. After this we changed to a dual solenoid valve called a redundant valve. The dual solenoid design gives you added protection against gas leaking thru

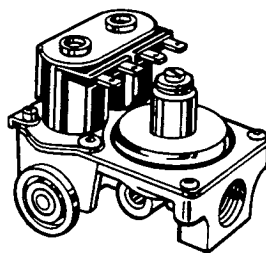
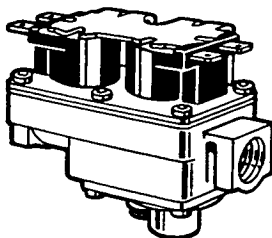
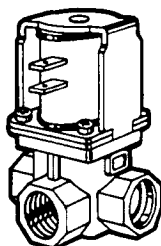
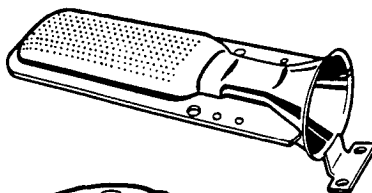
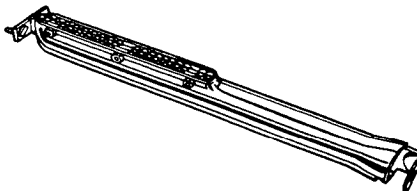
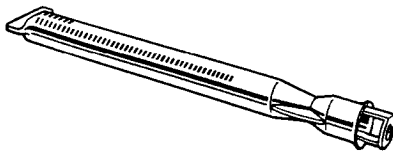
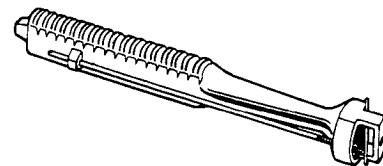

the valve body seats.

The valve plays an important part in regulating the pressure of the incoming gas. For example an incoming pressure of 12 inches is reduced to 10.5 inches.

We use a pre set pressure on the valves to insure a precise BTU rating of the furnace. In order to test a manifold pressure, valves come with a pressure tap to check the out-going pressure. You cannot test a manifold pressure at the orifice after the valve, it must be done only at the pressure tap with the furnace burning!!!

Once the valve receives 12vdc it should stay open until the thermostat is satisfied. The redundant valves will draw about .5 amps and the single solenoid will draw about .3. The park model furnaces use the same type valves but use a 24vac solenoid, and the amp draw is about the same.

Remember, always be sure to check for leaks when testing or working on the furnace valve and gas line assembly. A simple soap solution can do the job (Be safety minded when working on valves and burners). **YOU CANNOT REPAIR GAS VALVES, WHEN DEFECTIVE, REPLACE IT!!!**

PART SPECIFICATIONS

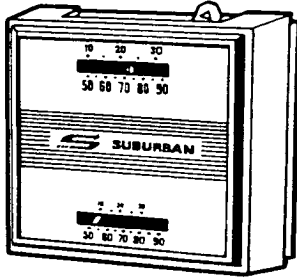

160902, Thermostat
Anticipator sets at .7

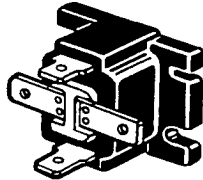

231202 Delay relay
ven # 607704A0-32
Off delay exp. 30 seconds

231625 Delay Relay
ven #60704A0-23
Off delay exp. 100 seconds

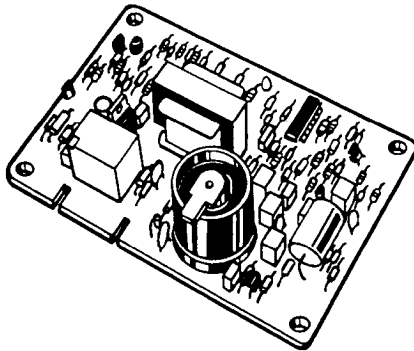

231741 Module Board and
230608 Module Board
Three try ignition
15 second delay
6.8 second spark and valve opening

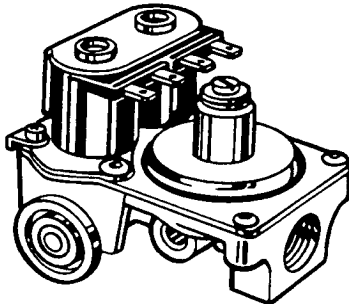

Valves, redundant series
.48 DC amp draw
Axp. 10.2 up to 10.5 manifold pressure

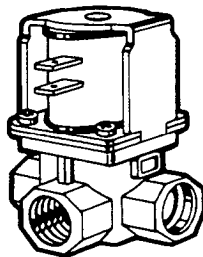

Valves, single solenoid pre 1985
.5 DC amp draw

PART SPECIFICATIONS

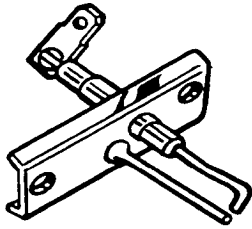

Local sense electrodes
1/8" spark gap

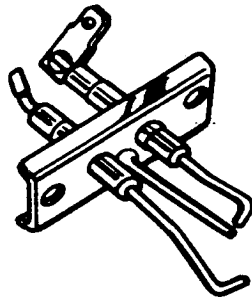

Remote sense electrodes
1/8" spark gap

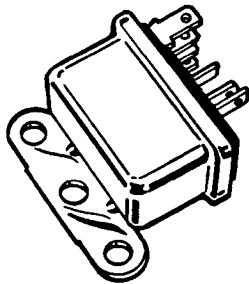

230423 Thermostat Relay pre 1985
.2 dc amp draw

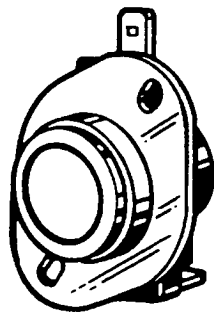

230575 Fan Switch pre 1985
145 degree close
normally open switch

PART SPECIFICATIONS

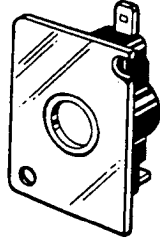

Limit Switches
normally closed

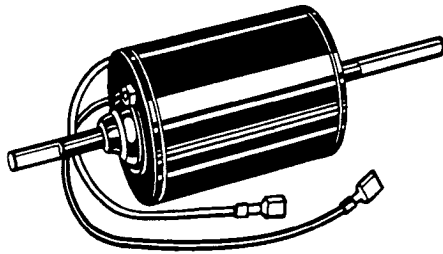

12 VDC Motors

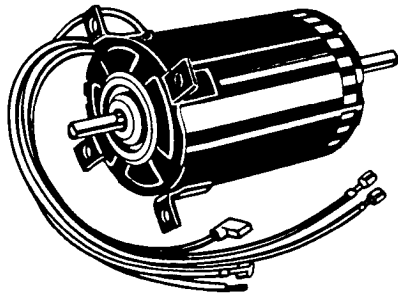

120 VAC Motors, Park Models
capacitor start

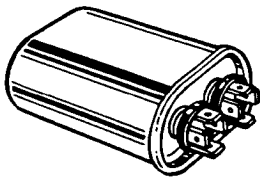

Capacitor for the above Park Model

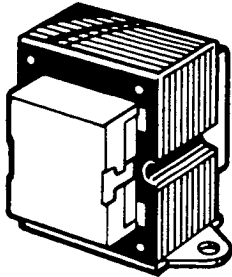

Transformer for the Park Model
120 VAC input 24 VAC output

INSTALLATION REQUIREMENTS -- ALL CURRENT MODELS

Models	Cir	Front	Cir	Top	Cir	Btm	Cir	Floor	Cir	Back	Cir	left	right	Ducts	Btm Duct	Sq Inch	Top Duct	Sq Inch	L & R Side Duct	Sq Inch	Return Air	Sq Inch
DD17P	See *1	0"	n/a	n/a	n/a	n/a	n/a	n/a	n/a	n/a	0"	0"	0"	1-4" Left side	n/a	n/a	n/a	n/a				
DD17DSI	See *1	0"	n/a	n/a	n/a	n/a	n/a	n/a	n/a	n/a	0"	0"	0"	1-4" Left side	n/a	n/a	n/a	n/a				
NT12S	3/8"	1"	n/a	n/a	n/a	n/a	n/a	n/a	n/a	n/a	1"	1"	1"	2-4"	n/a	n/a	n/a	n/a	25"	25"	55"	55"
NT16S	3/8"	1"	n/a	n/a	n/a	n/a	n/a	n/a	n/a	n/a	1"	1"	1"	2-4"	n/a	n/a	n/a	n/a	25"	25"	55"	55"
NT20S	3/8"	1"	n/a	n/a	n/a	n/a	n/a	n/a	n/a	n/a	1"	1"	1"	2-4"	n/a	n/a	n/a	n/a	25"	25"	55"	55"
NT12SE	See *1	5/8"	0"	0"	5/8"	5/8"	5/8"	5/8"	5/8"	5/8"	5/8"	5/8"	5/8"	n/a	n/a	n/a	n/a	n/a				
NT16SE	See *1	5/8"	0"	0"	5/8"	5/8"	5/8"	5/8"	5/8"	5/8"	5/8"	5/8"	5/8"	n/a	n/a	n/a	n/a	n/a				
NT20SE	See *1	5/8"	0"	0"	5/8"	5/8"	5/8"	5/8"	5/8"	5/8"	5/8"	5/8"	5/8"	n/a	n/a	n/a	n/a	n/a				
NT24SP	0"	0"	0"	0"	1"	1"	1"	1"	1"	1"	1"	1"	1"	3-4"	48"	n/a	n/a	36"	36"	55"	55"	55"
NT30SP	0"	0"	0"	0"	1"	1"	1"	1"	1"	1"	1"	1"	1"	3-4"	48"	n/a	n/a	36"	36"	55"	55"	55"
NT34SP	0"	0"	0"	0"	2"	2"	2"	2"	2"	2"	2"	2"	2"	4-4"	48"	n/a	n/a	48"	48"	55"	55"	55"
NT40	1"	1"	1"	1"	2"	2"	2"	2"	2"	2"	2"	2"	2"	4-4"	48"	n/a	n/a	48"	48"	113"	113"	113"
SF20	1"	0"	0"	0"	n/a	0"	0"	0"	0"	0"	0"	0"	0"	2-4"	56"	56"	56"	25"	55"	55"	55"	55"
SF25	1"	0"	0"	0"	n/a	0"	0"	0"	0"	0"	0"	0"	0"	3-4"	56"	56"	56"	36"	55"	55"	55"	55"
SF30	1"	0"	0"	0"	n/a	0"	0"	0"	0"	0"	0"	0"	0"	3-4"	56"	56"	56"	36"	55"	55"	55"	55"
SF35	1"	0"	0"	0"	n/a	0"	0"	0"	0"	0"	0"	0"	0"	4-4"	56"	56"	56"	48"	55"	55"	55"	55"
SF42	1"	1"	1"	1"	0"	0"	0"	0"	n/a	0"	2"	2"	2"	4-4"	72" *3	56"	56"	48"	See *2	See *2	See *2	See *2
P30	0"	0"	0"	0"	n/a	0"	0"	0"	n/a	0"	1"	1"	1"	4-4"	48"	n/a	n/a	48"	55"	55"	55"	55"
P40	1"	1"	1"	1"	0"	0"	0"	0"	n/a	0"	2"	2"	2"	4-4"	48"	n/a	n/a	48"	55"	55"	55"	55"

*1 - Special clearances for discharge grills. Refer to Installation and Instruction Manual.
 *2 - Return air should be 142" if 4 ducts are used. May be reduced to 88" if 5 ducts are used.
 *3 - Bottom duct requires the bottom duct kit # 520753

INSTALLATION

THE INSTALLATION IS THE LIFE SOURCE OF YOUR FURNACE, IF IT'S NOT INSTALLED PROPERLY IT CAN CAUSE MANY PREMATURE FAILURES

Any furnace will only work as well as it's installed, in the following we will discuss how to verify that the installation is correct. First we will look at a top ten list of things to look for in a bad installation and later how to correct them.

1. The bottom knock-out is not lined up over the plenum in the floor of the coach.
2. The knock-out is not fully open or the gasket is covering part of the opening.
3. The floor duct work is too small, restrictive, or has been collapsed.
4. An excessive amount of flex hose has been used.
5. The flex hose has too many angles, turns or has crushed area's in the duct work.
6. The return air is insufficient, not enough due to blockage or design.
7. Several or even one register is closed or blocked off.
8. Low voltage to the furnace, such as, the wire is too small leading to the furnace.
9. The thermostat wire is too long and or too small to carry the amp load.
10. Duct openings are too close to the return air of the furnace, causing a recirculating of heated air.

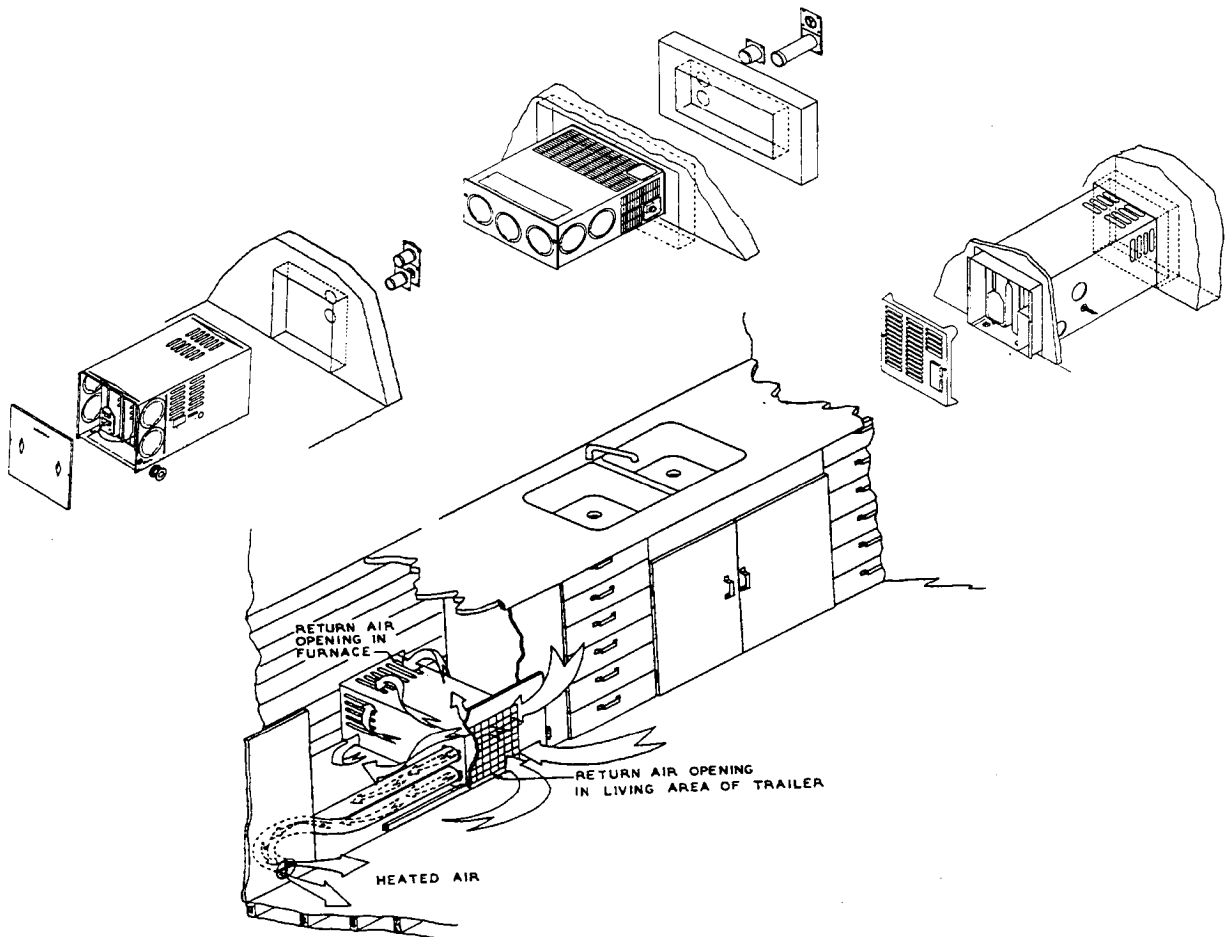

AIR FLOW

Proper air flow will increase efficiencies and lower operating cost

Any type of equipment, but especially the RV furnace, must have proper air flow to provide the correct air distribution inside the coach. The air outlets must be properly placed and directed at the greatest point of heat loss. Too much air flow can cause noise and drafts, too little and it will not allow sufficient air flow across the chamber. One way to tell there is not enough air flow is if the furnace cycles off on the limit switch.

Combustion air, proper combustion air depends on the room air motor, one motor provides both room air and combustion air with two separate blower wheels. Refer to the motor amp draw section on page 2.

Duct system, the duct system is the component that delivers the heated air into the coach living area, this may be round flex or hard metal under belly duct systems. The best equipment can be ruined if the duct system is not sized and installed properly.

Tightness of duct joints, when the duct joints or flex connectors are left loose, air will flow out into the return air area and also under cabinets. As a result of this the living area may not be heated and can cause limit problems for the furnace, make sure there are no loss of heated air. Also check the bottom plenum connection, make sure there is no air leaks between the duct, gasket or the bottom of the furnace cabinet.

Proper return air supply, for the furnace

to circulate the heated air, the return is as important as the supply duct system. Too small or restrictive return areas will result in a loss of heat output. Make sure that you have the proper free square inches of air flow into the return air area. (see duct system on page 12.)

Thermostat location is also a very important part of the air flow, it must be able to monitor the room air as it is being circulated through the coach, with no affects from cold windows, sunlight, or too close to the heated air.

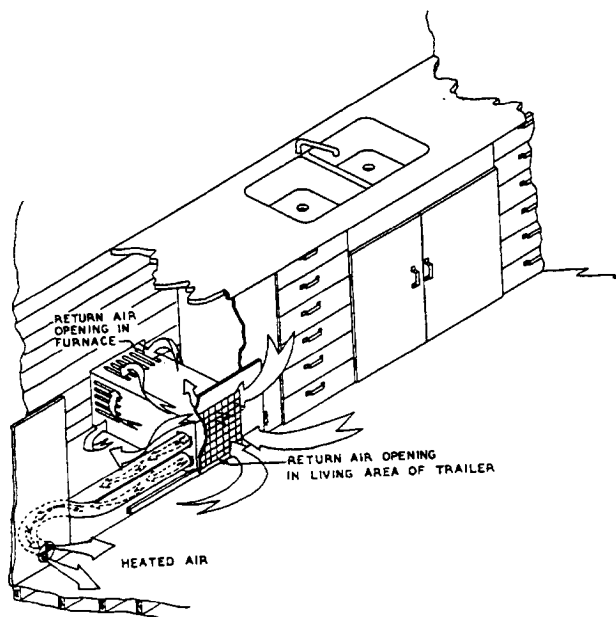

HOW TO TROUBLESHOOT FURNACE INSTALLATION AND OVERHEATING PROBLEMS

THE PURPOSE OF A FURNACE IS TO HEAT THE AIR THAT IS MOVED ACROSS THE CHAMBER, THIS IS CALLED A TEMPERATURE RISE (TR)

What exactly is TR? The temperature rise is the increase of temperature across the chamber. To measure this, take a reading of the room temperature or return air, and the output discharge of the furnace approximately 24" to 36" down the duct work from the furnace. The difference of the two equals, TR. Example, 70 degree return air and a 150 degree discharge air equals a TR of 80 degrees

One of the most overlooked troubleshooting concepts is the TR of the furnace. To any furnace TR is the precise measurement of how effectively it is operating, too low of a TR will not heat the space, too high and the furnace will cycle off on the limit.

What we need to look at is how to use this information to see if the furnace is operating correctly without wasting valuable shop time. Let's take a look at what we will need to perform this test.

A quality thermometer, one that can react quickly to temperatures, that's it! Also make sure the furnace has been operating for at least 5-10 minutes.

First place the thermometer at the return grill while the furnace is operating, take the reading and write it down, then go to the 24" to

36" section of duct work and read the temperature there, subtract the difference and have the TR. How do we use this information? An average temperature rise for a Suburban furnace is approximately 90 degrees, this is the range we would like to see, (actual temperatures may vary by 10-20 degrees). The furnace is rated for a maximum rise of 130 degrees, if this is the case of course it will cycle on the limit switch, 90 degrees is the best average range.

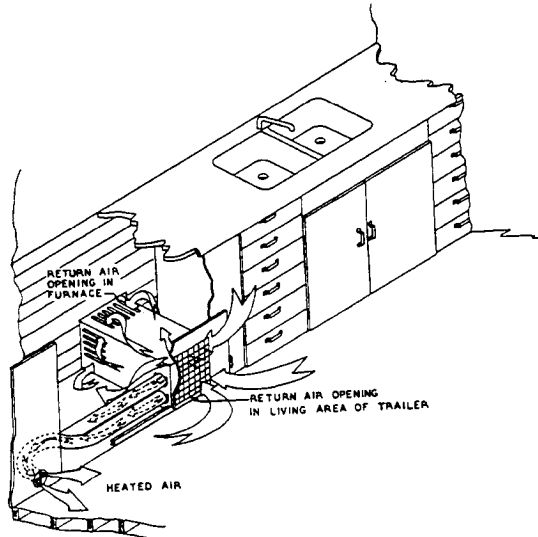

What if it's too high? Look for insufficient duct work, restrictions, lack of return air, slow motor speed, and as always check the gas pressure.

What if it's too low? In this case it might be a restriction in the orifice, low gas pressure, or a faulty gas valve.

What is too high or too low? Too high is over 110 degrees and too low is under 60 degrees. **You must also keep in mind that not all duct leads will have the same temperature reading.** The best bet is to read each one and take an average of all, if you are close to the high or low end of the scale.

How do you correct the problem? First you must find the source of the problem, then reverse it, just use common sense.

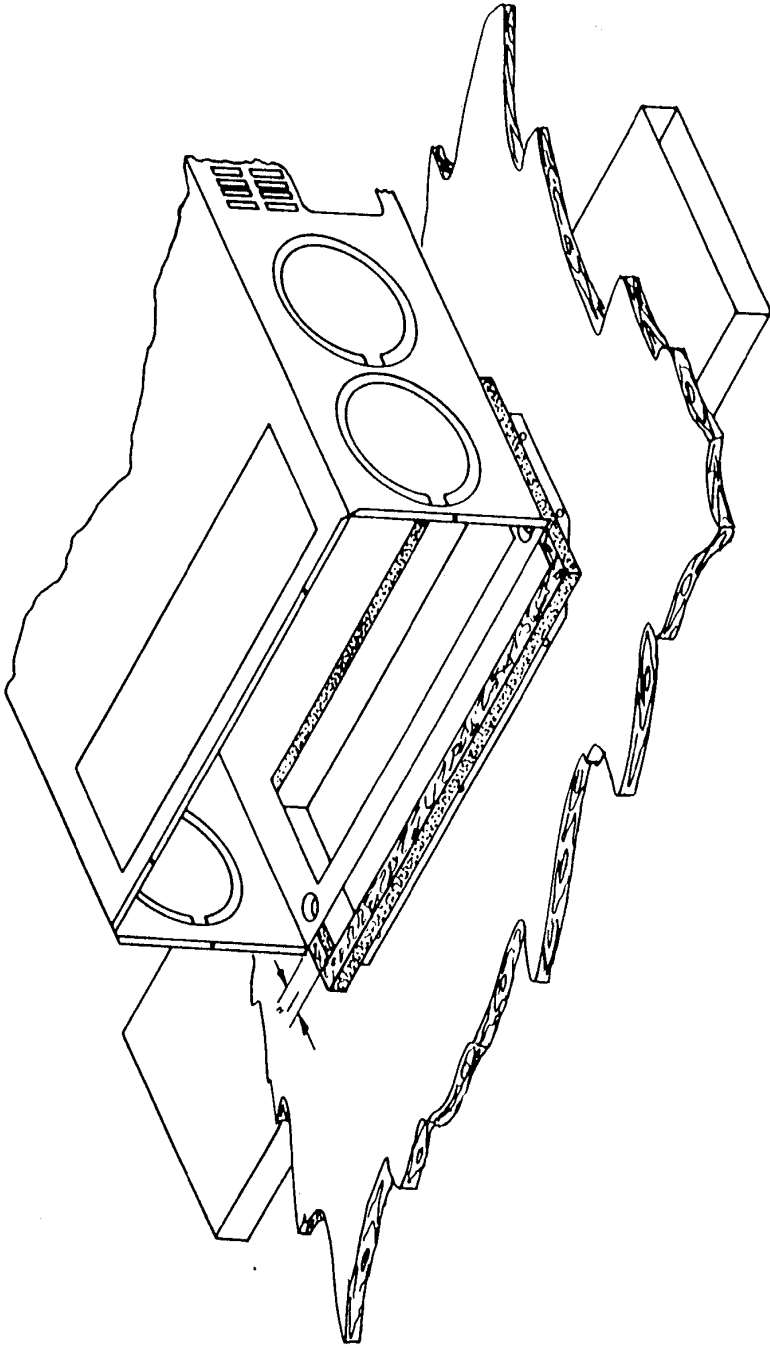

CLEANING AND MAINTENANCE

The first thing to always check for before you remove the unit for cleaning is for any visible signs of sooting on the vent. Operating a unit in this condition could lead to serious property damage, personal injury or loss of life. If soot is observed on the vent, immediately shut down the furnace and perform cleaning and maintenance.

WARNING! Do not install screens over the vent for any reason. Screens will become restricted and cause unsafe furnace operation. For your safety and others, use only genuine factory authorized parts on your furnace.

First, when removing the furnace make sure the vent is free of obstructions, void of soot and properly terminated to the atmosphere.

Second, in order to properly clean the chamber it must be disassembled and blown out with high pressure air, **WARNING**, do not block off the outlets while pressurizing the unit, damage will occur.

Third, once the chamber is clean and free of rust and soot, reassemble the unit being sure to replace all worn and deteriorated gaskets. Make sure the burner is cleaned also before placing back into the unit, (cast iron burners must be checked for proper air shutter adjustment once cleaning has been preformed).

Fourth, observe the main burner flame and make sure its a hard blue flame with well defined burner ports. If the flame appears yellow or lazy, shut down the furnace and recheck the chamber and burner assembly or air shutter adjustment.

