

Thecus

N3200XXX/N0503
N4100PRO
N4200 series
N5200XXX/N5500
1U4200XXX/1U4600
N7700 series
N2200XXX
N8200XXX/N8800 series

User's Manual v7.0

Copyright and Trademark Notice

Thecus and other names of Thecus products are registered trademarks of Thecus Technology Corp. Microsoft, Windows, and the Windows logo are registered trademarks of Microsoft Corporation. Apple, iTunes and Apple OS X are registered trademarks of Apple Computers, Inc. All other trademarks and brand names are the property of their respective owners. Specifications are subject to change without notice.

Copyright © 2012 Thecus Technology Corporation. All rights reserved.

About This Manual

All information in this manual has been carefully verified to ensure its correctness. In case of an error, please provide us with your feedback. Thecus Technology Corporation reserves the right to modify the contents of this manual without notice.

Product name:

Thecus N2200XXX/N3200XXX/N0503/N4100PRO/N4200 series
/N5200XXX/N5500/1U4200XXX/1U4600/N7700 series/N8800 series/N8200XXX

Manual Version: 7.0

Release Date: July 2012

Limited Warranty

Thecus Technology Corporation guarantees all components of Thecus NAS products are thoroughly tested before they leave the factory and should function normally under general usage. In case of any system malfunctions, Thecus Technology Corporation and its local representatives and dealers are responsible for repair without cost to the customer if the product fails within the warranty period and under normal usage. Thecus Technology Corporation is not responsible for any damage or loss of data deemed to be caused by its products. It is highly recommended that users conduct necessary back-up practices.

Safety Warnings

For your safety, please read and follow the following safety warnings:













-  Read this manual thoroughly before attempting to set up your Thecus IP storage.
-  Your Thecus IP storage is a complicated electronic device. DO NOT attempt to repair it under any circumstances. In the case of malfunction, turn off the power immediately and have it repaired at a qualified service center. Contact your vendor for details.
-  DO NOT allow anything to rest on the power cord and DO NOT place the power cord in an area where it can be stepped on. Carefully place connecting cables to avoid stepping or tripping on them.
-  Your Thecus IP storage can operate normally under temperatures between 5°C and 40°C, with relative humidity of 20% – 85%. Using Thecus IP storage under extreme environmental conditions could damage the unit.
-  Ensure that the Thecus IP storage is provided with the correct supply voltage (AC 100V ~ 240V, 50/60 Hz). Plugging the Thecus IP storage to an incorrect power source could damage the unit.
-  Do NOT expose Thecus IP storage to dampness, dust, or corrosive liquids.
-  Do NOT place Thecus IP storage on any uneven surfaces.
-  DO NOT place Thecus IP storage in direct sunlight or expose it to other heat sources.
-  DO NOT use chemicals or aerosols to clean Thecus IP storage. Unplug the power cord and all connected cables before cleaning.
-  DO NOT place any objects on the Thecus IP storage or obstruct its ventilation slots to avoid overheating the unit.
-  Keep packaging out of the reach of children.
-  If disposing of the device, please follow your local regulations for the safe disposal of electronic products to protect the environment.

Table of Contents

Copyright and Trademark Notice	2
About This Manual	2
Limited Warranty.....	2
Safety Warnings	3
Table of Contents	4
Chapter 1: Introduction.....	8
Overview	8
Product Highlights.....	8
Package Contents	10
Front Panel.....	11
Hard Disk Trays	21
Rear Panel.....	24
Chapter 2: Hardware Installation	35
Overview	35
Before You Begin.....	35
Cable Connections	35
Checking System Status	37
System Status Normal.....	37
System Trouble	37
Chapter 3: First Time Setup.....	43
Overview	43
Thecus Setup Wizard	43
LCD Operation	
(N4100PRO/N5200XXX/N5500/1U4200XXX/1U4600/N7700	
series/N8200XXX/N8800 series)	45
LCD Operation (N3200XXX/N0503).....	47
OLED Operation (N4200 series).....	48
Typical Setup Procedure	49
Chapter 4: System Administration	51
Overview	51
Web Administration Interface	51
My Favorite.....	52
Menu Bar.....	54
Message Bar	55
System Information.....	56
General Information	56
System/Service Status	56
Logs.....	57
On-line Register	58
Syslog Management	59
System Management	60
Date and Time: System Date and settings	60
Notification configuration	61
Firmware Upgrade	62
Schedule Power On/Off.....	62
Administrator password	63
Config Mgmt	64
Factory default	65
Reboot & Shutdown	65

File System check	65
Wake-Up On LAN (WOL)	67
SNMP Support	67
UI Login Configuration	68
System Network	68
WAN/LAN1	68
LAN2	70
DHCP Server Configuration	71
Storage Management	71
Disks Information	71
RAID Information	74
Space Allocation	84
iSCSI Thin-Provisioning	89
Advance Option	93
Stackable NAS	94
ISO Mount	100
Share Folder	103
Folder and sub-folders Access Control List (ACL)	108
User and Group Authentication	110
ADS/NT Support	111
Local User Configuration	113
Local Group Configuration	115
Batch Create Users and Groups	117
Quota	118
Network Service	119
Samba / CIFS	119
AFP (Apple Network Setup)	120
NFS Setup	121
FTP	121
TFTP	122
HTTP/ Web Disk	122
UPnP	123
Bonjour Setting	123
Application Server	124
iTunes® Server	124
Module Installation	124
Auto Module Installation	125
Backup	126
Nsync (Does not apply to the 3x series)	126
Nsync Target (Does not apply to the 3X series)	129
Dual DOM (Not available on N3200XXX/N0503/N4200Eco/N7700/N8800 NAS)	129
Rsync Target Server	130
Rsync	131
Thecus Backup Utility	132
Windows XP Data Backup	133
Apple OS X Backup Utilities	134
External Devices	134
Printer Information	134
UPS Setting	140
Chapter 5: Using Thecus IP Storage	141
Overview	141
Login Page	141
Using the Web Disk (Does not apply to the 3X series' Web Disk)	141
Photo Server (Does not apply to the 3X series' photo server)	144
Windows XP Publishing Wizard	144
Managing Albums and Photos	149

Creating Albums	150
Password Protecting Albums.....	150
Uploading Pictures to Albums	150
EXIF Information	151
Slide Shows	151
Mapping a Client PC to the Thcus IP Storage	152
Windows.....	152
Apple OS X	152
Mapping Thcus IP storage as an iSCSI Drive	152
Windows 2000/XP.....	153
Windows Vista.....	157
Chapter 6: Tips and Tricks	157
USB and eSATA Storage Expansion.....	157
Adding a Spare Disk	157
Remote Administration.....	157
Part I - Setup a DynDNS Account.....	158
Part II - Enable DDNS on the Router	158
Part III - Setting up Virtual Servers (HTTPS)	158
Firewall Software Configuration	158
Replacing Damaged Hard Drives.....	159
Hard Drive Damage	159
Replacing a Hard Drive	159
RAID Auto-Rebuild	159
Chapter 7: Troubleshooting	160
Forgot My Network IP Address	160
Can't Map a Network Drive in Windows XP	160
Restoring Factory Defaults	160
Problems with Time and Date Settings	161
Dual DOM Supports for Dual Protection	161
Chapter 8: Updated for FW v5.02.01.....	162
Add module login through UI Login Interface.....	162
UI Login Configuration.....	163
Share Folder	163
User Quota	166
User and Group Backup	168
Samba / CIFS.....	168
FTP	171
WebService (HTTP/ Web Disk).....	172
Rsync Target Server.....	173
Rsync	174
ACL Backup and Restore.....	176
Uninterrupted Power Source (UPS Setting).....	177
Link Aggregation mode description	178
Chapter 9: Updated for FW v5.03.01.....	180
System Monitor	180
Appendix A: Customer Support.....	183
Appendix B: RAID Basics	184
Overview	184
Benefits	184
Improved Performance	184
Data Security	184
RAID Levels.....	184
Appendix C: Active Directory Basics	187
Overview	187

What is Active Directory?	187
ADS Benefits.....	187
Appendix D: Licensing Information	188
Overview	188
Source Code Availability	188
CGIC License Terms.....	189
GNU General Public License.....	189

Chapter 1: Introduction

Overview

Thank you for choosing the Thecus IP Storage Server. The Thecus IP storage is an easy-to-use storage server that allows a dedicated approach to storing and distributing data on a network. Data reliability is ensured with RAID features that provide data security and recovery—over multiple Terabyte of storage are available using RAID 5 and RAID 6 (depending on model). Gigabit Ethernet ports enhance network efficiency, allowing Thecus IP storage to take over file management functions, increase application and data sharing and provide faster data response. The Thecus IP storage offers data mobility with a disk roaming feature that lets you swap working hard drives for use in other Thecus IP storage, securing the continuity of data in the event of hardware failure. The Thecus IP storage allows data consolidation and sharing between Windows (SMB/CIFS), UNIX/Linux, and Apple OS X environments. The Thecus IP storage's user-friendly GUI supports multiple Languages.

Product Highlights

File Server

First and foremost, the Thecus IP storage allows you to store and share files over an IP network. With a Network Attached Storage (NAS) device, you can centralize your files and share them easily over your network. With the easy-to-use web-based interface, users on your network can access these files in a snap.

To learn about the Web User Interface, go to

Chapter 5: Using the Thecus IP Storage > [Using WebDisk](#).

FTP Server

With the built-in FTP Server, friends, clients, and customers can upload and download files to your Thecus IP storage over the Internet with their favorite FTP programs. You can create user accounts so that only authorized users have access.

To set up the FTP Server, refer to

Chapter 4: System Administration>Network service> [FTP](#) .

iTunes Server

With the built-in iTunes server capability, the Thecus IP storage enables digital music to be shared and played anywhere on the network!

To set up the iTunes Server, refer to

Chapter 4: Application Server>[iTunes Configuration](#).

Backup Server

Don't leave precious data to chance. With advanced backup capabilities, you can easily upload mission critical files to the Thecus IP storage, and even automate your backup tasks for true peace-of-mind.

To find out how to backup your files with the Thecus IP storage, refer to

Chapter 4: Backup > [Nsync](#). (Does not apply to the 3x series)

Printer Server

With the Thecus IP storage's Printer Server, you can easily share an IPP printer with other PCs connected to your network.

To set up the Printer Server, refer to

Chapter 4: External Device > Printer Information.

Multiple RAID

Thecus IP storage supports multiple RAID volumes on one system. So, you can create RAID 0 for your non-critical data, and create RAID 1, 5 or 6 (depend on model) for mission-critical data. Create the RAID levels depending on your needs.

To configure RAID modes on the Thecus IP storage, refer to

Chapter 4: Storage Management > RAID Information.

iSCSI Capability

Thecus IP storage is not only a file server, but it also supports iSCSI initiators. Your server can access Thecus IP storage as a direct-attached-storage over the LAN or Internet. There is no easier way to expand the capacity of your current application servers. All the storage needs can be centrally managed and deployed. This brings ultimate flexibility to users.

To set up an iSCSI volume, refer to

Chapter 4: Storage Management > Space Allocation > Allocating Space for iSCSI Volume.

Superior Power Management

Thecus IP storage supports schedule power on/off. With this feature, administrator can set at what time to turn on or off the system. This feature is a big plus for people who want to conserve energy. Wake-On-LAN enables administrator to remotely turn on the system without even leaving their own seat.

To schedule system on and off, refer to

Chapter 4: System Management > Scheduled Power On/Off

Package Contents

The Thecus IP storage should contain the following common items:

- System Unit x1
- QIG (Quick Installation Guide) x1
- CD-Title x3 (Acronics backup CD , Twonky media server CD & Universal CD)
- Ethernet Cable x1
- Accessory bag x1
- HDD Compatibility list Card x1
- Multiple Languages Warranty Card x1
- Power cord x1

Your N3200XXX package should contain additional items:

- 3.5" HDD rail x6
- Power Adaptor + Power cord x1

Your N0503 package should contain additional items:

- 3 to 5 HDD cage x1 (Installed)
- 3.5" HDD rail x6
- Power Adaptor + Power cord x1

Your N4200 series package should contain additional items:

- Power adapter + Power cordx1

Your N5500 package should contain additional items:

- USB Cable (A-B Type) x1

Your 1U4200XXX package should contain additional items:

- Power Cord
 - 1U4200XXXRx1

Your 1U4600 package should contain additional items:

- Power Cord
 - 1U4600Rx1
- USB Cable (A-B Type) x1

Your N8800/N8200XXX series package should contain additional items:

- Power Cord x1

Please check to see if your package is complete. If you find that some items are missing, contact your dealer.

Front Panel

N2200XXX:

The Thecus N2200XXX's front panel has the device's controls, indicators, and hard disk trays:

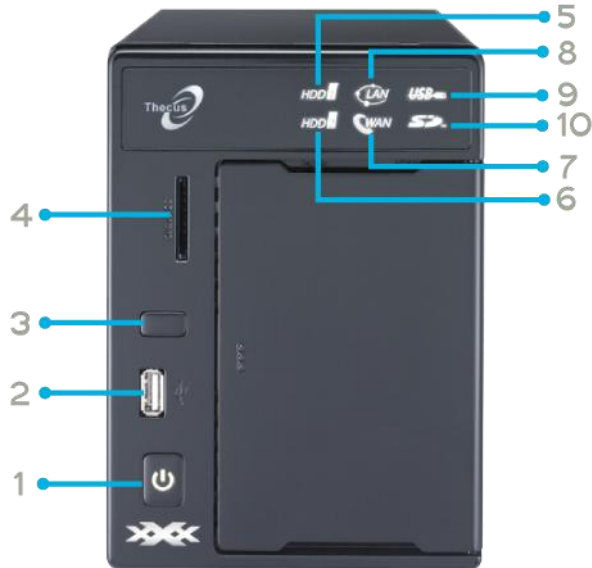

Front Panel	
Item	Description
1. Power Button	<ul style="list-style-type: none"> • Powers the N2200XXX on/off.
2. USB Port	<ul style="list-style-type: none"> • USB 2.0 port for compatible USB devices, such as digital cameras, USB disks, and USB printers.
3. USB Copy Button	<ul style="list-style-type: none"> • Copies USB storage contents to N2200XXX.
4. Card reader	<ul style="list-style-type: none"> • Supports SD/SDHC/MMC cards via USB interface.
5. HDD1 led	<ul style="list-style-type: none"> • Blinking white: HDD activity
6. HDD2 led	<ul style="list-style-type: none"> • Blinking white: HDD activity
7. WAN led	<ul style="list-style-type: none"> • Solid white: WAN Cable link • Blinking white: Network activity
8. LAN led	<ul style="list-style-type: none"> • Solid white: LAN Cable link • Blinking : Network activity
9. USB Copy led	<ul style="list-style-type: none"> • Blinking white: USB copy activity
10. Card reader led	<ul style="list-style-type: none"> • Blinking white: Card reader copy activity

N3200XXX:

The Thecus N3200XXX's front panel has the device's controls, indicators, and hard disk trays:

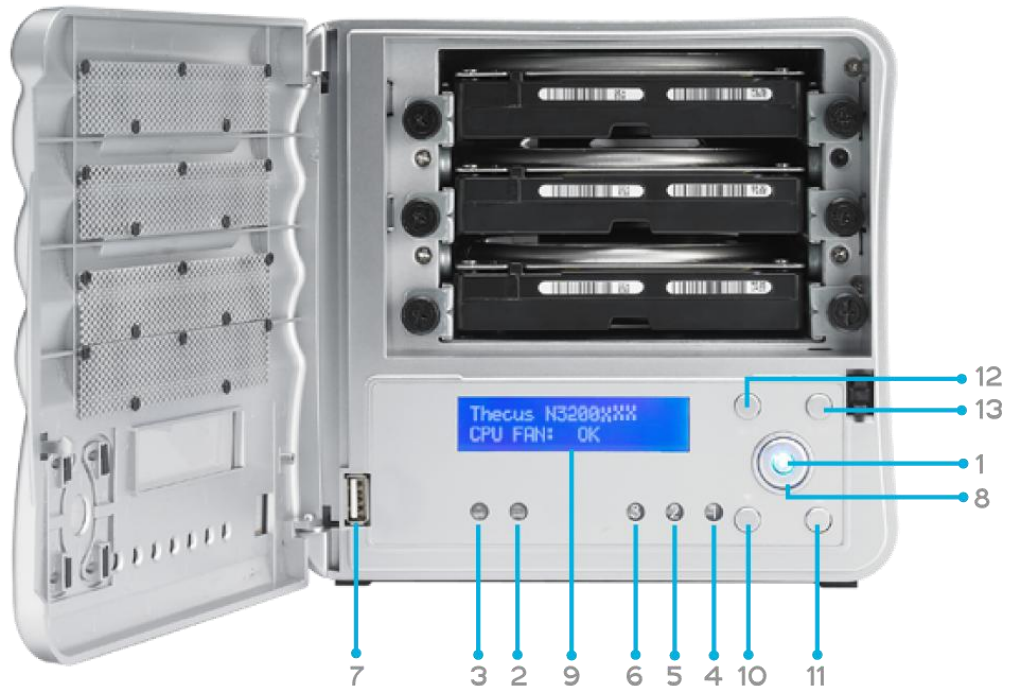

Front Panel	
Item	Description
1. Power LED	<ul style="list-style-type: none"> • Solid blue: System is powered on
2. WAN/LAN1 LED	<ul style="list-style-type: none"> • Solid green: Network link • Blinking orange: Network activity
3. LAN2 LED	<ul style="list-style-type: none"> • Solid green: Network link • Blinking orange: Network activity
4. HDD 1 LED	<ul style="list-style-type: none"> • Solid red: HDD failed • Blinking orange: HDD activity
5. HDD 2 LED	<ul style="list-style-type: none"> • Solid red: HDD failed • Blinking orange: HDD activity
6. HDD 3 LED	<ul style="list-style-type: none"> • Solid red: HDD failed • Blinking orange: HDD activity
7. USB Port	<ul style="list-style-type: none"> • USB 2.0 port for compatible USB devices, such as digital cameras, USB disks, and USB printers.
8. Power Button	<ul style="list-style-type: none"> • Powers the N3200XXX on/off. • Solid blue: Device is powered on
9. LCD Display	<ul style="list-style-type: none"> • Displays current system status and messages (Update time: 60 seconds).
10. Down Button ▼	<ul style="list-style-type: none"> • Push to scroll DOWN when using the LCD display.
11. Up Button ▲	<ul style="list-style-type: none"> • Push to scroll UP when using the LCD display.
12. Enter Button ↵	<ul style="list-style-type: none"> • Push to confirm information entered into the LCD display.
13. Escape Button ESC	<ul style="list-style-type: none"> • Push to leave the current LCD menu.

N0503:

The Thecus N0503's front panel has the device's controls, indicators, and hard disk trays:

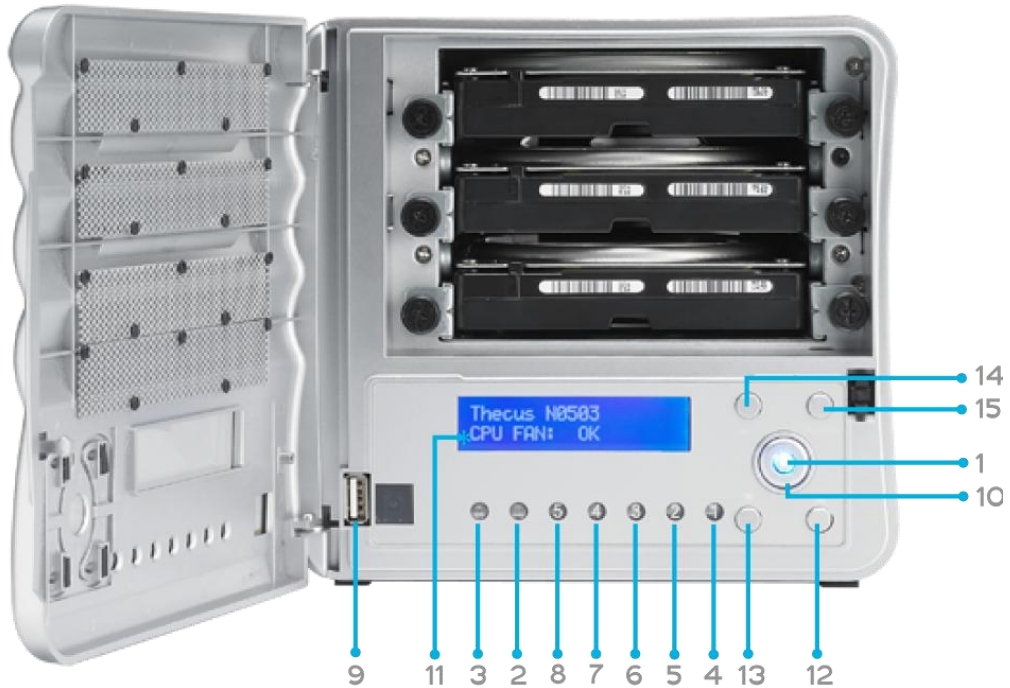

Front Panel	
Item	Description
Power LED	<ul style="list-style-type: none"> • Solid blue: System is powered on
WAN/LAN1 LED	<ul style="list-style-type: none"> • Solid green: Network link • Blinking orange: Network activity
LAN2 LED	<ul style="list-style-type: none"> • Solid green: Network link • Blinking orange: Network activity
HDD 1 LED	<ul style="list-style-type: none"> • Solid red: HDD failed • Blinking orange: HDD activity
HDD 2 LED	<ul style="list-style-type: none"> • Solid red: HDD failed • Blinking orange: HDD activity
HDD 3 LED	<ul style="list-style-type: none"> • Solid red: HDD failed • Blinking orange: HDD activity
HDD 4 LED	<ul style="list-style-type: none"> • Solid red: HDD failed • Blinking orange: HDD activity
HDD 5 LED	<ul style="list-style-type: none"> • Solid red: HDD failed • Blinking orange: HDD activity
USB Port	<ul style="list-style-type: none"> • USB 2.0 port for compatible USB devices, such as digital cameras, USB disks, and USB printers.
Power Button	<ul style="list-style-type: none"> • Powers the N0503 on/off. • Solid blue: Device is powered on
LCD Display	<ul style="list-style-type: none"> • Displays current system status and messages (Update time: 60 seconds).
Down Button ▼	<ul style="list-style-type: none"> • Push to scroll DOWN when using the LCD display.
Up Button ▲	<ul style="list-style-type: none"> • Push to scroll UP when using the LCD display.
Enter Button ↵	<ul style="list-style-type: none"> • Push to confirm information entered into the LCD display.
Escape Button ESC	<ul style="list-style-type: none"> • Push to leave the current LCD menu.

N4100PRO

The N4100PRO's front panel displays the unit's array of status LED's and is also where you'll find the power buttons. See the table below for a detailed explanation of each:

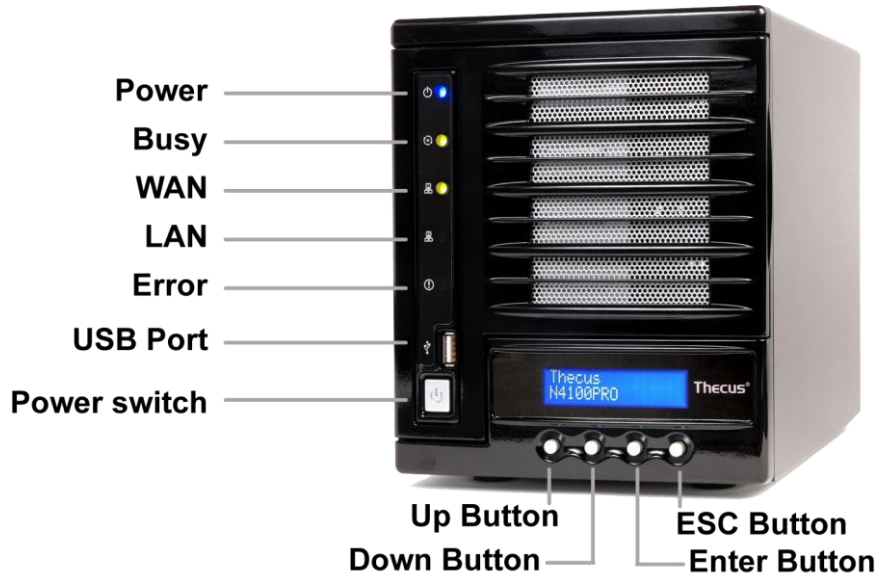

Item	Description
HDD Trays	<ul style="list-style-type: none"> There are four hard disk drive (HDD) trays. Each tray supports a 3.5-inch SATA HDD. The trays have locks for added physical security and keys are provided with the package.
Power LED	<ul style="list-style-type: none"> Solid blue: N4100PRO is powered on
Busy LED	<ul style="list-style-type: none"> Blinking orange: system startup or maintenance; data inaccessible Off: system startup complete; system operating normally
WAN LED	<ul style="list-style-type: none"> Solid green: network link Blinking green: network activity
LAN LED	<ul style="list-style-type: none"> Solid green: network link Blinking green: network activity
Error LED	<ul style="list-style-type: none"> Solid red: system error detected
Power Button	<ul style="list-style-type: none"> Power on/off N4100PRO

N4200 series:

The Thecus N4200series front panel has the device's controls, indicators, and hard disk trays:

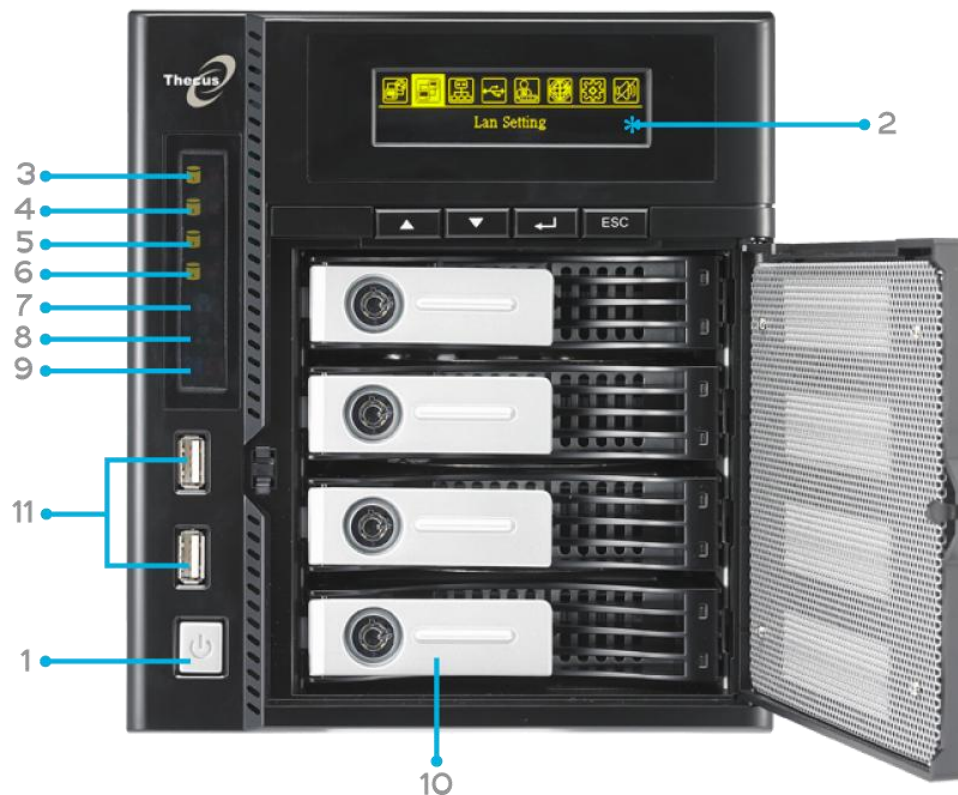

Front Panel	
Item	Description
1.Power Button	<ul style="list-style-type: none"> Power on/off N4200series
2.OLED	<ul style="list-style-type: none"> Displays current system status and messages OLED screen saver will be enabled after screen is left idle for more than 3 mins OLED screen will be disabled after it is left idle for more than 6 mins
OLED	3.HDD 1 LED <ul style="list-style-type: none"> Yellow: HDD activity Red: HDD failure
	4.HDD 2 LED <ul style="list-style-type: none"> Yellow: HDD activity Red: HDD failure
	5.HDD 3 LED <ul style="list-style-type: none"> Yellow: HDD activity Red: HDD failure
	6.HDD 4 LED <ul style="list-style-type: none"> Yellow: HDD activity Red: HDD failure
	7.WAN/LAN1 LED <ul style="list-style-type: none"> Blinking green: network activity
	8.LAN2 LED <ul style="list-style-type: none"> Blinking green: network activity
9.USB Copy	<ul style="list-style-type: none"> Blue: USB Copy activity Red: USB Copy failure
10.HDD Tray	<ul style="list-style-type: none"> Four HDD trays support 4x 3.5" or 4 x 2.5" HDDs
11.USB Copy Button	<ul style="list-style-type: none"> Copies USB storage contents to the N4200 series.
12.USB Port	<ul style="list-style-type: none"> USB 2.0 port for compatible USB devices, such as USB disks.

N5200XXX/N5500:

The Thecus N5500 front panel has the device's controls, indicators, and hard disk trays:

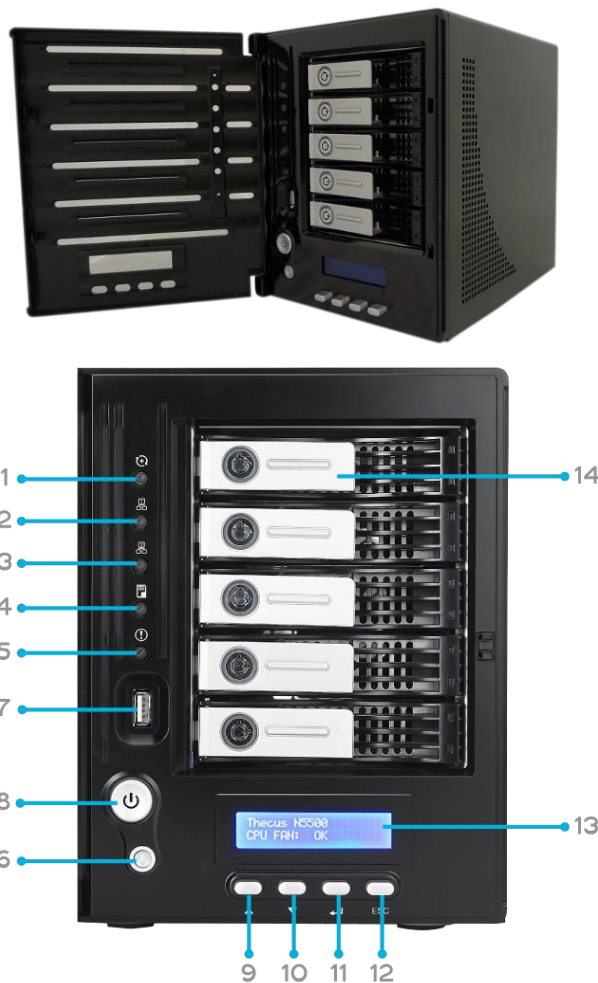

Front Panel	
Item	Description
1. System LED	<ul style="list-style-type: none"> • Blinking orange: System is being upgraded or is starting up; data currently inaccessible
2. WAN/LAN1 LED	<ul style="list-style-type: none"> • Solid green: Network link • Blinking green: Network activity
3. LAN2 LED	<ul style="list-style-type: none"> • Solid green: Network link • Blinking green: Network activity
4. USB Copy LED	<ul style="list-style-type: none"> • Solid blue: Files are being copied from a USB storage device
5. System Warning LED	<ul style="list-style-type: none"> • Solid RED: System error
6. Reset Button	<ul style="list-style-type: none"> • Resets system configuration to default value.
7. USB Port	<ul style="list-style-type: none"> • USB 2.0 port for compatible USB devices, such as USB disks.
8. Power Button/ Power LED	<ul style="list-style-type: none"> • Power on/off N5200XXX/N5500 and Power LED. • Solid blue: System is power on.
9. Up Button ▲	<ul style="list-style-type: none"> • Push to scroll up when using the LCD display.
10. Down Button ▼	<ul style="list-style-type: none"> • Push to enter the USB copy operation screen.
11. Enter Button ↵	<ul style="list-style-type: none"> • Push to enter LCD administrator password to access basic system setting.
12. Escape Button ESC	<ul style="list-style-type: none"> • Push to leave the current LCD menu.
13. LCD Display	<ul style="list-style-type: none"> • Displays current system status and warning messages.
14. HDD Trays	<ul style="list-style-type: none"> • Five 3.5" SATA HDD trays. • Locks are provided for added security.

N7700 Series:

The Thecus N7700 series front panel has the device's controls, indicators, and hard disk trays:

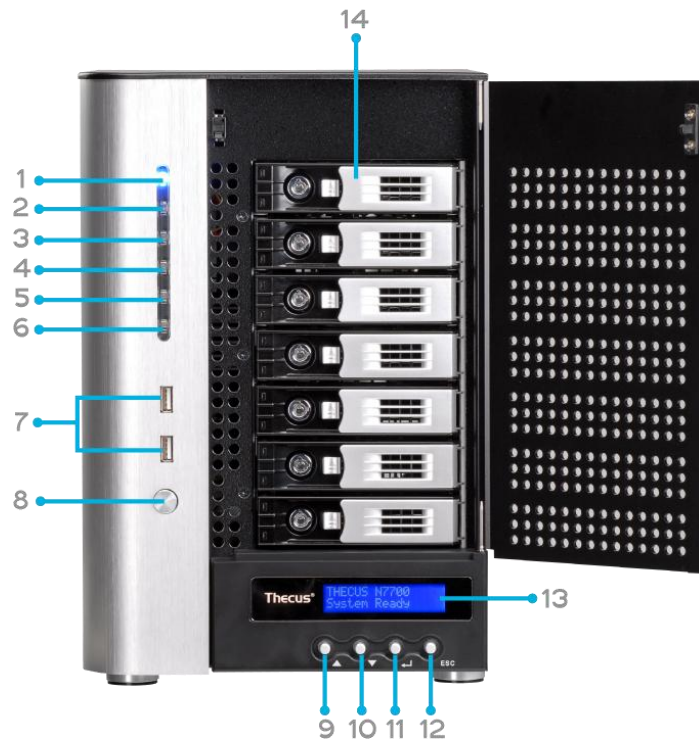

Front Panel	
Item	Description
1.Power LED	• Solid blue: System is power on.
2.System LED	• Solid orange: system is being upgraded or system startup; data currently inaccessible
3.WAN/LAN1 LED	• Solid green: network link • Blinking green: network activity
4.LAN2 LED	• Solid green: network link • Blinking green: network activity
5.USB Copy LED	• Solid blue: files are being copied from a USB storage device
6.eSATA link LED	• Solid blue: external eSATA device has connected
7.USB Port	• USB 2.0 port for compatible USB devices, such as USB disks.
8.Power Button	• Power on/off N7700
9.Up Button ▲	• Push to scroll up when using the LCD display
10.Down Button ▼	• Push to enter USB copy operation screen
11.Enter Button ↵	• Push to enter LCD operate password for basic system setting
12.Escape Button ESC	• Push to leave the current LCD menu
13.LCD Display	• Displays current system status and warning messages
14.HDD Trays	• Seven 3.5" SATA HDD trays • Locks are provided for added security

1U4200XXX:

The Thecus 1U4200XXX front panel has the device's controls, indicators, and hard disk trays:

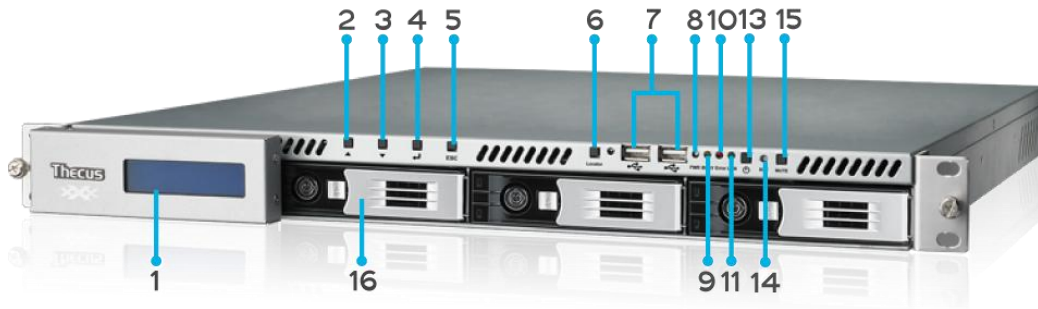

Front Panel	
Item	Description
1. LCD Display	<ul style="list-style-type: none"> Displays the current system status and warning messages. Displays hostname, WAN/LAN1/LAN2 IP addresses, RAID status, and current time.
2. Up Button ▲	<ul style="list-style-type: none"> Push to scroll up when using the LCD display.
3. Down Button ▼	<ul style="list-style-type: none"> Push to scroll down when using the LCD display.
4. Enter Button ↵	<ul style="list-style-type: none"> Push to confirm information entered into the LCD display.
5. Escape Button ESC	<ul style="list-style-type: none"> Push to leave the current LCD menu.
6. Locator Button	<ul style="list-style-type: none"> Turns on the LED backlight.
7. USB Port	<ul style="list-style-type: none"> USB 2.0 port for compatible USB devices, such as digital cameras, USB disks, and USB printers.
8. PWR LED	<ul style="list-style-type: none"> Solid Blue: System is powered on.
9. Busy LED	<ul style="list-style-type: none"> Blinking orange: system startup or system maintenance; data currently inaccessible
10. Error LED	<ul style="list-style-type: none"> Solid Red: System alert: Redundant power or system fan failure
11. LAN LED	<ul style="list-style-type: none"> Solid green: network link Blinking green: network activity
12. Power Button	<ul style="list-style-type: none"> Power the 1U4200XXX on/off.
13. Reset Button	<ul style="list-style-type: none"> Resets the 1U4200XXX.
14. Mute Button	<ul style="list-style-type: none"> Mutes the system fan alarm (Can also be managed through the UI)
15. HDD Trays	<ul style="list-style-type: none"> Four 3.5" SATA HDD trays. Locks are provided for added security.

1U4600:

The Thecus 1U4600 front panel has the device's controls, indicators, and hard disk trays:

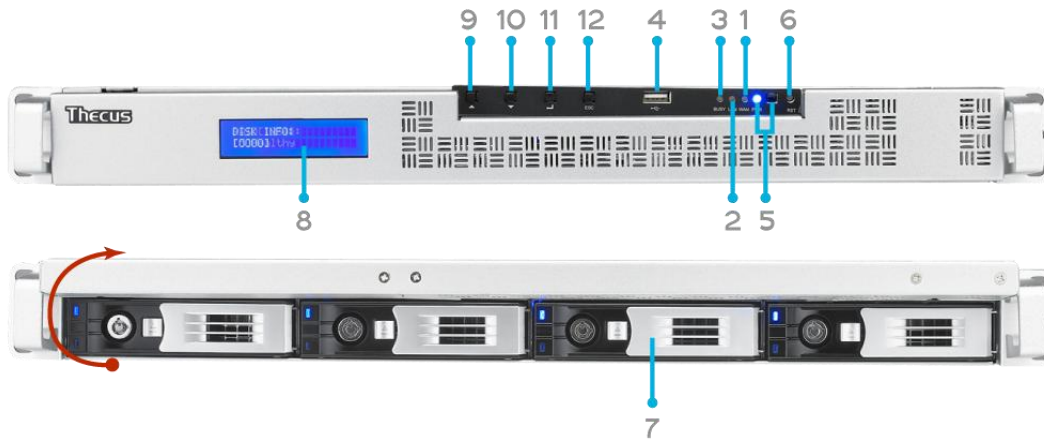

Front Panel	
Item	Description
1. WAN/LAN1 LED	<ul style="list-style-type: none"> • Solid green: network link • Blinking green: network activity
2. LAN2 LED	<ul style="list-style-type: none"> • Solid green: network link • Blinking green: network activity
3. Busy LED	<ul style="list-style-type: none"> • Blinking orange: system startup or system maintenance; data currently inaccessible
4. USB Port	<ul style="list-style-type: none"> • USB 2.0 port for compatible USB devices, such as digital cameras, USB disks, and USB printers
5. Power Button	<ul style="list-style-type: none"> • Power on/off 1U4600 • Solid blue: Device is powered on • Blinking blue: eSATA hard disk is connected and active
6. Reset Button	<ul style="list-style-type: none"> • Resets the 1U4600 • Press for five seconds during boot process to reset IP address and admin password
7. HDD Trays	<ul style="list-style-type: none"> • Four 3.5" SATA HDD trays • Locks are provided for added security
8. LCD Display	<ul style="list-style-type: none"> • Displays current system status and warning messages • Displays hostname, WAN/LAN1/LAN2 IP address, RAID status, and current time
9. Up Button ▲	<ul style="list-style-type: none"> • Push to scroll up when using the LCD display
10. Down Button ▼	<ul style="list-style-type: none"> • Push to scroll down when using the LCD display
11. Enter Button ↵	<ul style="list-style-type: none"> • Push to confirm information entered into the LCD display
12. Escape Button ESC	<ul style="list-style-type: none"> • Push to leave the current LCD menu

N8200XXX/N8800 series:

The Thecus N8200XXX/N8800 series front panel has the device's controls, indicators, and hard disk trays:



Front Panel	
Item	Description
1.Power Button	• Power on/off N8200XXX/N8800
2.Power LED	• Solid green: System is power on.
3.Reboot Button	• Press to system reboot
4.System fan alarm LED	• Solid red: system fan failure notification
5. Mute button	• Mute the system fan alarm.
6.USB Port	USB 2.0 port for compatible USB devices, such as USB disks, USB printers
7.Up Button ▲	• Push to scroll up when using the LCD display
8.Down Button ▼	• Push to enter USB copy operation screen
9.Enter Button ↵	• Push to enter LCD operate password for basic system setting
10.Escape Button ESC	• Push to leave the current LCD menu

Hard Disk Trays

1U4200XXX/N2200XXX/N8200XXX:

Each of above mentioned models' hard disk trays has a lock, a latch, and two LED indicators:

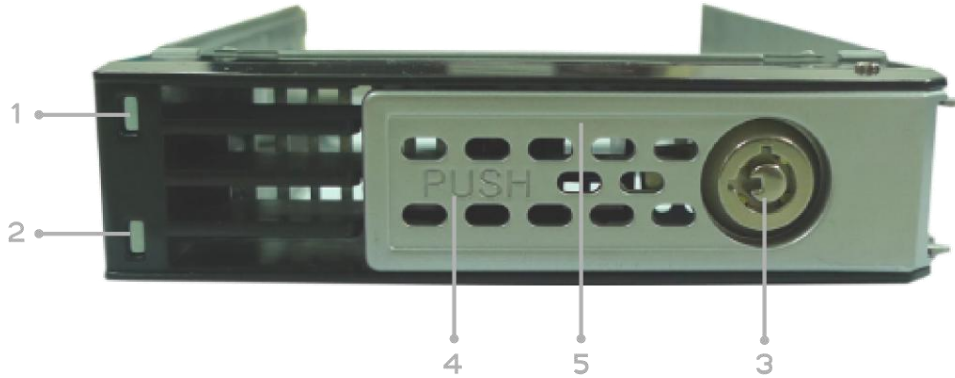

Hard Disk Trays	
Item	Description
1.HDD Power LED	• Solid blue: Hard disk is powered on
2.HDD Access/Error LED	• Blinking green: System is accessing data on the hard disk • Solid red: HDD fail
3.Lock	• Use the lock to physically secure the hard disk to the unit.
4.Latch	• Use to open and remove or close and secure the tray.
5.Handle	• Pull to remove the HDD tray.

1U4600/N7700 series/N8800series:

Each of mentioned above models hard disk trays has a lock, a latch, and two LED indicators:

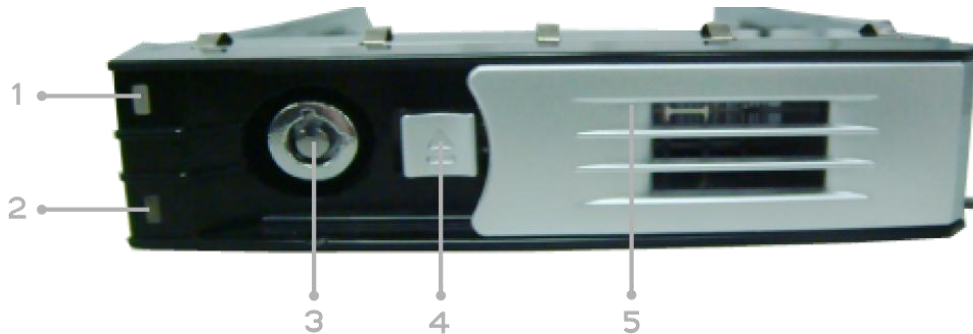

Hard Disk Trays	
Item	Description
1.HDD Power LED	• Solid blue: Hard disk is powered on
2.HDD Access/Error LED	• Blinking green: System is accessing data on the hard disk • Solid red: HDD fail
3.Lock	• Use the lock to physically secure the hard disk to the unit.
4.Latch	• Use to open and remove or close and secure the tray.
5.Handle	• Pull to remove the HDD tray.

N4100PRO

The N4100PRO's hard disk trays each have a lock, a latch, and two indicators.



Item	Description
Lock	<ul style="list-style-type: none"> The tray lock lets you physically secure the HDD with accessory keys.
Latch	<ul style="list-style-type: none"> Use the latch to open and remove or close and secure the tray.
HDD Power LED	<ul style="list-style-type: none"> Solid blue: HDD is powered on
Access/Error LED	<ul style="list-style-type: none"> Blinking yellow: data is being accessed Blinking red: hard disk error

N4200 series/N5200XXX/N5500:

Each of the N4200 series/N5200XXX/N5500's hard disk trays has a lock, a latch, and two LED indicators:

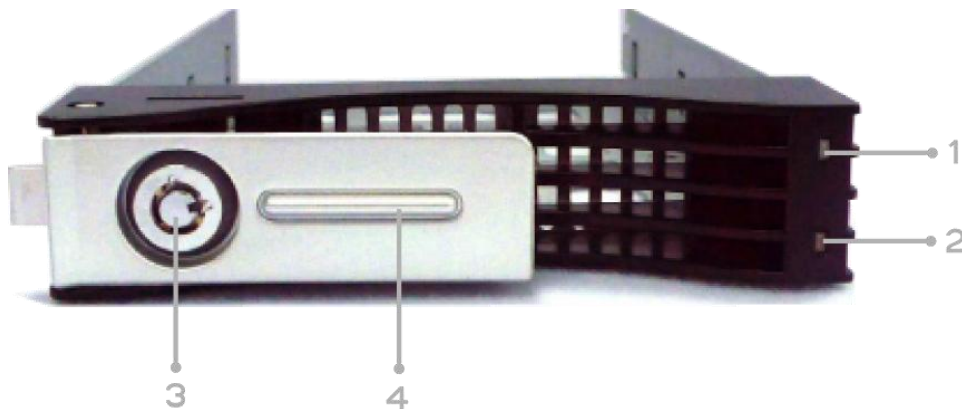

Hard Disk Trays	
Item	Description
1.HDD Power LED	<ul style="list-style-type: none"> Solid blue: Hard disk is powered on(No function on N4200 series)
2.HDD Access/Error LED	<ul style="list-style-type: none"> Blinking green: System is accessing data on the hard disk Solid red: HDD fail (No function on N4200 series)
3.Lock	<ul style="list-style-type: none"> Use the lock to physically secure the hard disk to the unit.
4.Handle	<ul style="list-style-type: none"> Pull to remove the HDD tray.

N3200XXX:

The N3200XXX only supports 3.5" Serial ATA (SATA) hard disks. To install a hard disk into the N3200XXX, follow the steps below:

1. Open the front door of the N3200XXX.
2. For 3.5" HDD:
 - a. Get the hard drive rails and place them on either side of the hard drive, fitting into the appropriate grooves.
 - b. Holding the hard drive rails in place, slide the hard disks into the N3200XXX until they snap into place.
 - c. Tighten the thumbscrews.



N0503:

The N0503 supports both 2.5" and 3.5" Serial ATA (SATA) hard disks. To install a hard disk into the N0503, follow the steps below:

3. Open front door of the N0503.
4. For 3.5" HDD
 - a. Get the hard drive rails and place them on either side of the hard drive, fitting into the appropriate grooves.
 - b. Holding the hard drive rails in place, slide the hard disks into the N0503 until they snap into place.
 - c. Tighten the thumbscrews.
5. For 2.5" HDD
 - a. Remove the included 2.5" HDD tray.
 - b. Slide the 2.5" HDD into the 2.5" HDD cage.
 - c. Slide the 2.5" HDD cage back in until it snap into place.
6. Replace the N0503 front cover.



Rear Panel

N2200XXX:

The N2200XXX rear panel features ports and connectors.

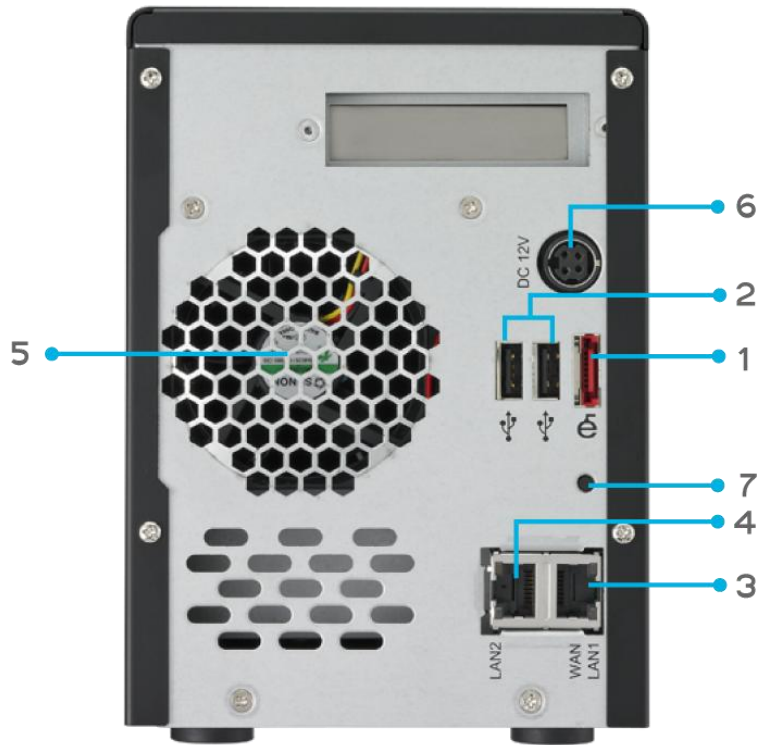

Back Panel	
Item	Description
1. eSATA Port	<ul style="list-style-type: none">eSATA port for high-speed external storage expansion.
2. USB Port	<ul style="list-style-type: none">USB 2.0 port for compatible USB devices, such as digital cameras, USB disks, and USB printers.
3. WAN/LAN1 Port	<ul style="list-style-type: none">WAN/LAN1 port for connecting to an Ethernet network through a switch or a router.
4. LAN2 Port	<ul style="list-style-type: none">LAN2 port for connecting to a local Ethernet network through a switch or a router.
5. System Fan	<ul style="list-style-type: none">System fan that exhausts heat from the unit.
6. Power Connector	<ul style="list-style-type: none">Connect the included power cords to this connector.
7. Reset Button	<ul style="list-style-type: none">Resets the N2200XXX.Pressing and holding the Reset button on the back for 5 seconds will reset your network setting and password, and turn off Jumbo Frame Support.

N3200XXX/N0503:

The N3200XXX/N0503 rear panel features ports and connectors.



Back Panel	
Item	Description
1. eSATA Port	<ul style="list-style-type: none">eSATA port for high-speed storage expansion
2. USB Port	<ul style="list-style-type: none">USB 2.0 port for compatible USB devices, such as digital cameras, USB disks, and USB printers
3. WAN/LAN1 Port	<ul style="list-style-type: none">WAN/LAN1 port for connecting to an Ethernet network through a switch or router
4. LAN2 Port	<ul style="list-style-type: none">LAN2 port that can be used for connection sharing
5. System Fan	<ul style="list-style-type: none">System fan that exhausts heat from the unit
6. Power Connector	<ul style="list-style-type: none">Connect the included power cords to these connectors
7. Reset Button	<ul style="list-style-type: none">Resets the N3200XXX/N0503Immediately press and hold the Reset button on the back for 5 seconds. This will reset your network setting, password, and turn off Jumbo Frame Support.

N4100PRO

The rear panel of the N4100PRO houses the USB and Ethernet connections, as well as the power connector. See the table below for descriptions of each:

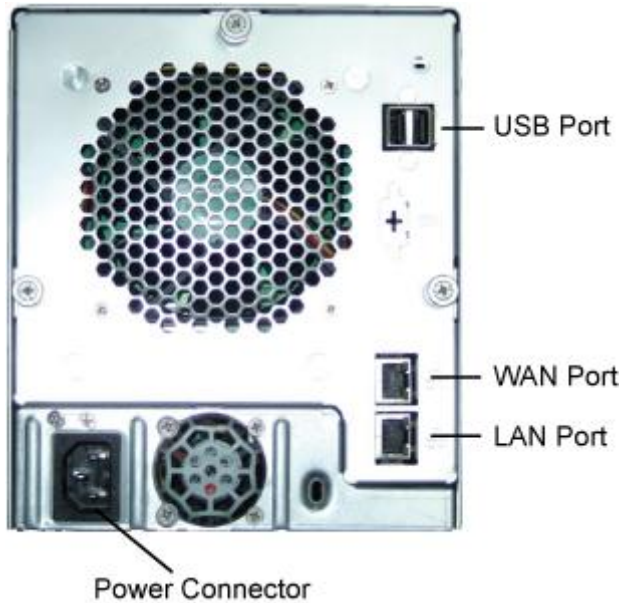

Item	Description
Power Connector	<ul style="list-style-type: none">• Connect the included power cord to this connector
WAN Port	<ul style="list-style-type: none">• WAN port for connecting to an Ethernet network through a switch or router
LAN Port	<ul style="list-style-type: none">• LAN port for connecting to an Ethernet network through a switch or router
USB Ports	 <ul style="list-style-type: none">• USB 2.0 ports for storage expansion

N4200 series:

The N4200 rear panel features ports and connectors.

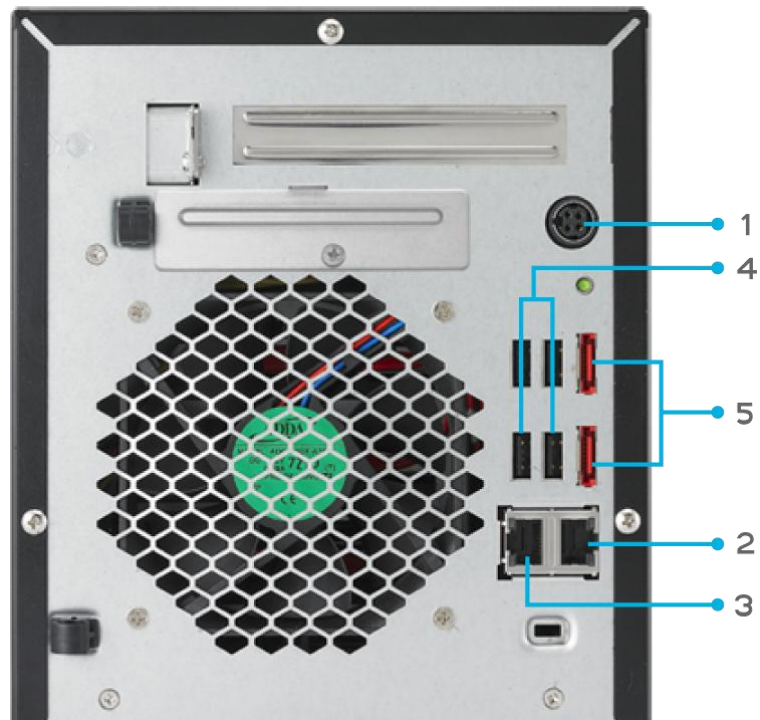

Back Panel	
Item	Description
Power Connector	<ul style="list-style-type: none">For connect the power adaptor
WAN/LAN1 Port	<ul style="list-style-type: none">WAN/LAN1 port for connecting to an Ethernet network through a switch or router
LAN2 Port	<ul style="list-style-type: none">LAN2 port for connecting to an Ethernet network through a switch or router
USB Ports	 <ul style="list-style-type: none">USB 2.0 ports for storage expansion
eSATA Ports	<ul style="list-style-type: none">eSATA port for high-speed storage expansion

N5200XXX:

The N5200XXX rear panel features ports and connectors.

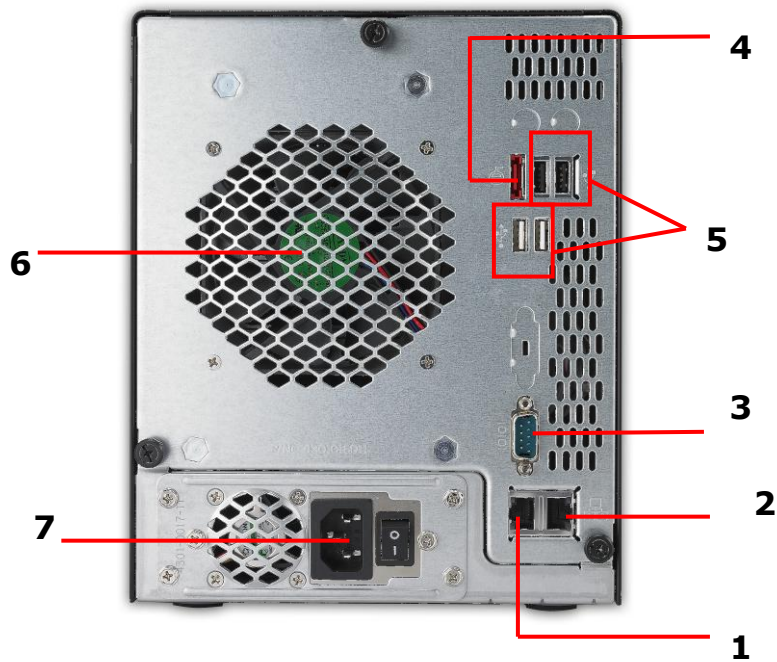

Back Panel	
Item	Description
1.WAN/LAN1 Port	• WAN/LAN1 port for connecting to an Ethernet network through a switch or a router.
2.LAN2 Port	• LAN2 port for connecting to a local Ethernet network through a switch or router.
3.Serial Port	• This port is for an external UPS device.
4.eSATA Port	• eSATA port for high-speed external storage expansion.
5.USB Port	• USB 2.0 port for compatible USB devices, such as USB disks and USB printers.
6.System Fan	• System fan that exhausts heat from the unit.
7.Power Connector	• Connect the included power cord to this connector.

N5500:

The N5500 rear panel features ports and connectors.

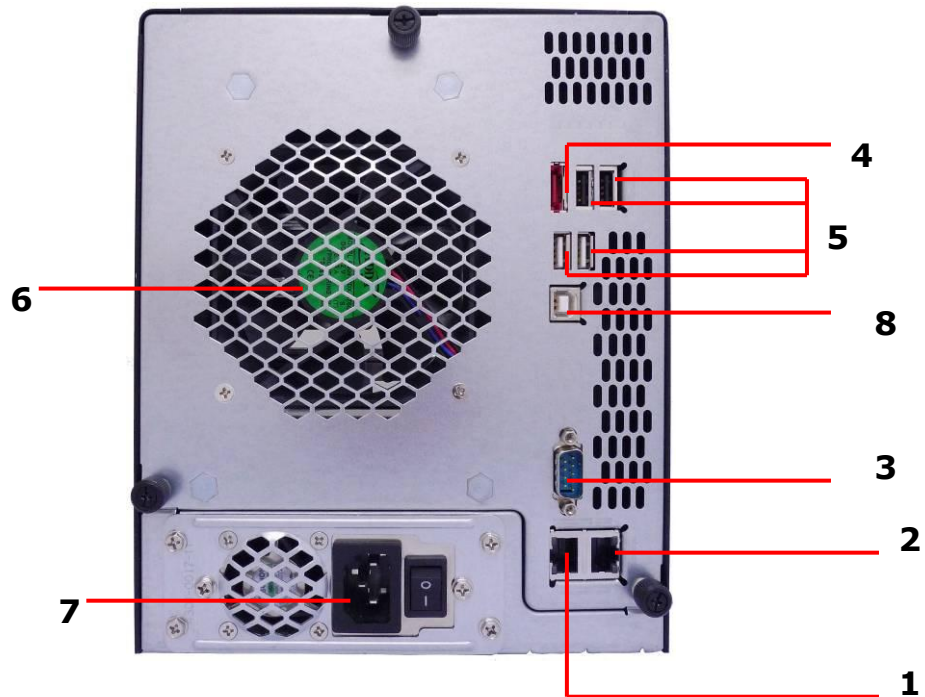

Back Panel	
Item	Description
1.WAN/LAN1 Port	• WAN/LAN1 port for connecting to an Ethernet network through a switch or router.
2.LAN2 Port	• LAN2 port for connecting to an Ethernet network through a switch or router.
3.Serial Port	• This port is for external UPS device.
4.eSATA Port	• eSATA port for high-speed storage expansion.
5.USB Port (Type A)	• USB 2.0 port for compatible USB devices, such as USB disks, and USB printers.
6.System Fan	• System fan that exhausts heat from the unit.
7.Power Connector	• Connect the included power cord to this connector.
8.USB Port (Type B)	• USB 2.0 port to connect PC (Type B of target mode).

N7700 series:

The N7700 rear panel features ports and connectors.

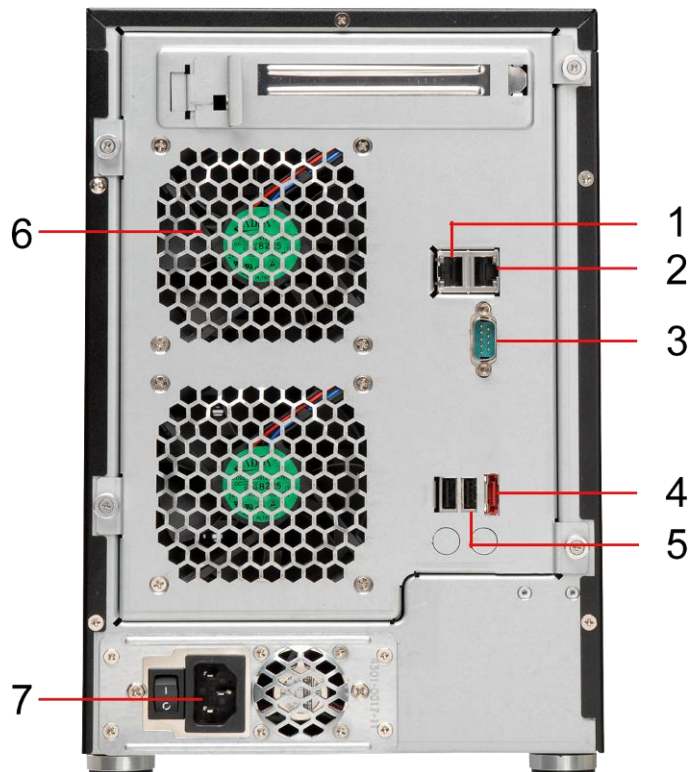

Back Panel	
Item	Description
1.LAN2 Port	• LAN2 port for connecting to a local Ethernet network through a switch or router.
2.WAN/LAN1 Port	• WAN/LAN1 port for connecting to an Ethernet network through a switch or router.
3.Serial Port	• This port is for an external UPS device.
4.eSATA Port	• eSATA port for high-speed storage expansion.
5.USB Port	• USB 2.0 port for compatible USB devices, such as USB disks, and USB printers.
6.System Fan	• System fan that exhausts heat from the unit.
7.Power Connector	• Connect the included power cord to this connector.

1U4200XXR:

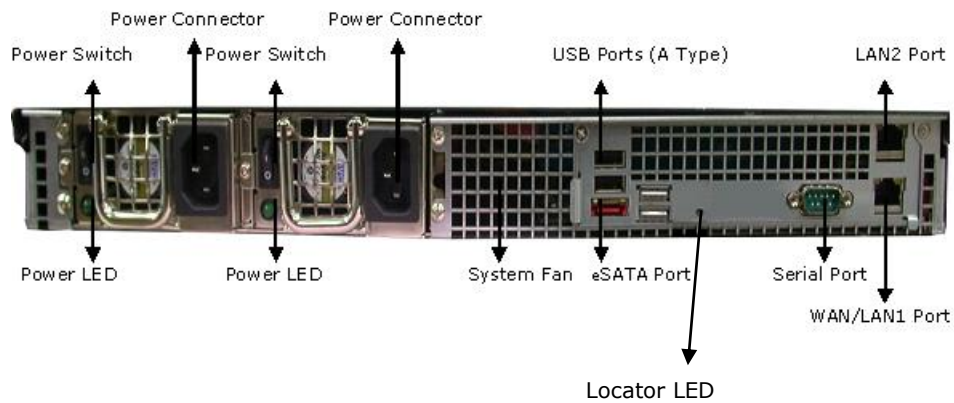

1U4200 Back Panel	
Item	Description
eSATA Port	• eSATA port for high-speed storage expansion.
USB Ports	• USB 2.0 ports for compatible USB devices, such as digital cameras, USB disks, and USB printers.
WAN/LAN1 Port	• WAN/LAN1 port for connecting to an Ethernet network through a switch or router.
LAN2 Port	• LAN2 port that can be used for connection sharing.
Power Switch	• Switch for power supply.
System Fan	• System fan that exhausts heat from the unit.
Serial Port	• This port is for factory use only.
Locator LED	• Identifies each NAS within a rack mount configuration.
Power Connector	• Connect the included power cords to these connectors.

1U4200XXS:

The rear panel of the 1U4200XXS is similar to the 1U4200XXR, but with a single power connector:

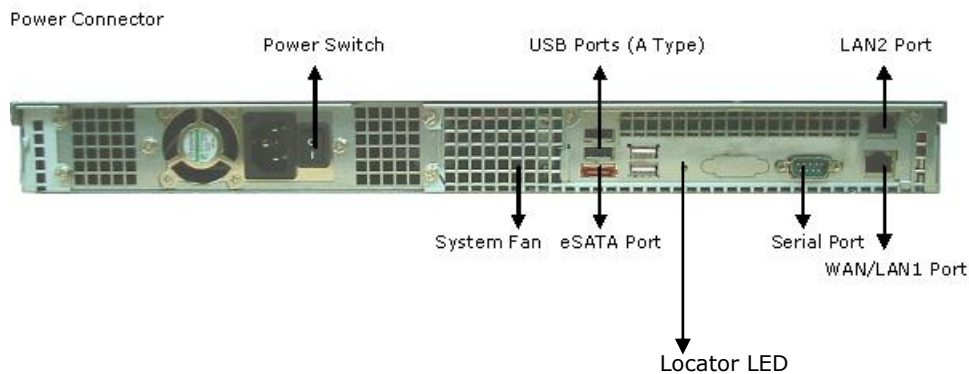

1U4600R:

The rear panel of the 1U4600R houses most of the USB and Ethernet connections, as well as the eSATA port, system fan, and power connector. See the table below for descriptions of each:

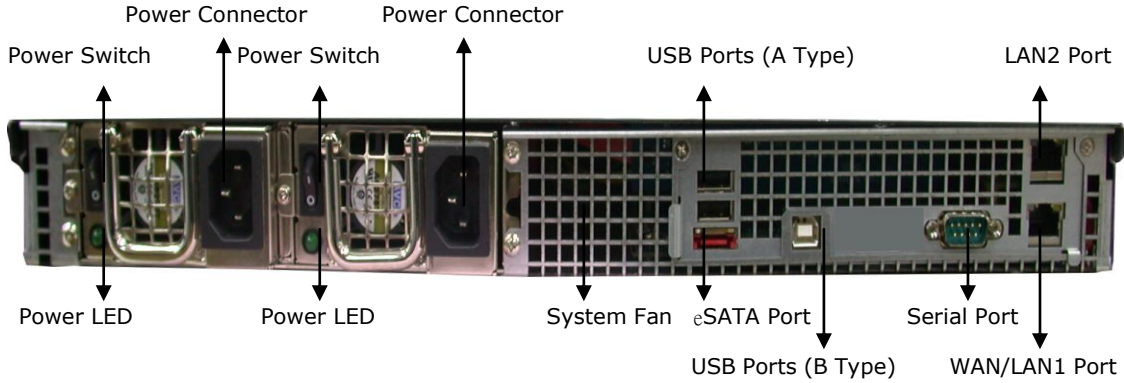

1U4600 Back Panel	
Item	Description
eSATA Port	<ul style="list-style-type: none"> eSATA port for high-speed storage expansion
USB Ports	<ul style="list-style-type: none"> USB 2.0 ports for compatible USB devices, such as digital cameras, USB disks, and USB printers
WAN/LAN1 Port	<ul style="list-style-type: none"> WAN/LAN1 port for connecting to an Ethernet network through a switch or router
LAN2 Port	<ul style="list-style-type: none"> LAN2 port that can be used for connection sharing
Power Switch	<ul style="list-style-type: none"> Switch for power supply
System Fan	<ul style="list-style-type: none"> System fan that exhausts heat from the unit
Serial Port	<ul style="list-style-type: none"> This port is for factory use only
Power Connector	<ul style="list-style-type: none"> Connect the included power cords to these connectors

1U4600S:

The rear panel of the 1U4600S is similar to the 1U4600R, but with a single power connector:

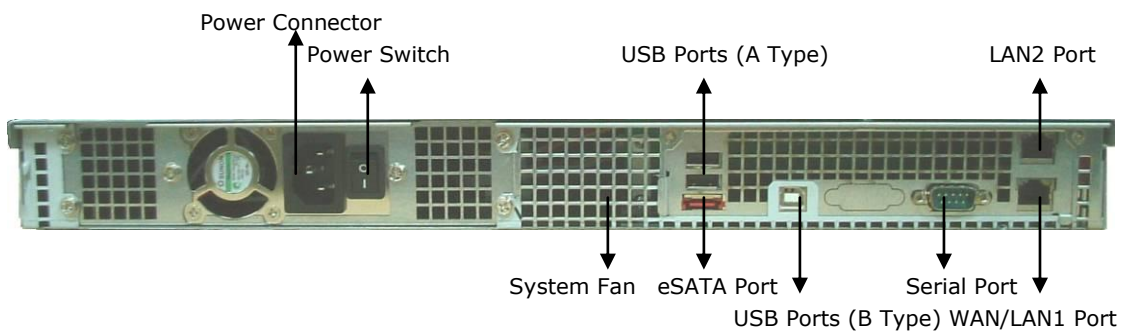

N8200XXX:

The N8200XXX rear panel features ports and connectors.

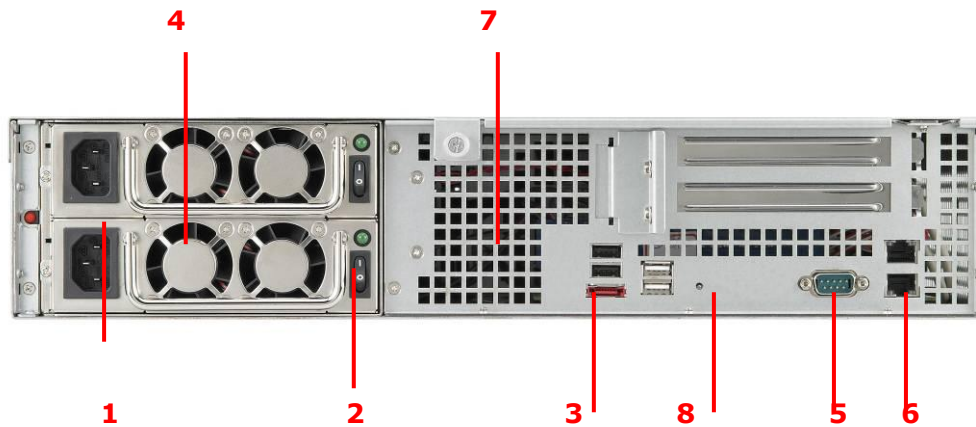

Back Panel	
Item	Description
1. Power Connector	• Connect the included power cords to these connectors.
2. Power Switch	• Powers the N8200XXX on/off.
3. eSATA Port	• eSATA port for high-speed storage expansion.
4. USB Port	• USB 2.0 port for compatible USB devices, such as USB disks, and USB printers.
5. Serial Port	• This port is for an external UPS device.
6. WAN/LAN1 Port	• WAN/LAN1 port for connecting to an Ethernet network through a switch or router.
7. LAN2 Port	• WAN/LAN1 port for connecting to a local Ethernet network through a switch or router.
8. Locator LED	• Identifies each NAS within a rack mount configuration.

N8800 series:

The N8800 rear panel features ports and connectors.

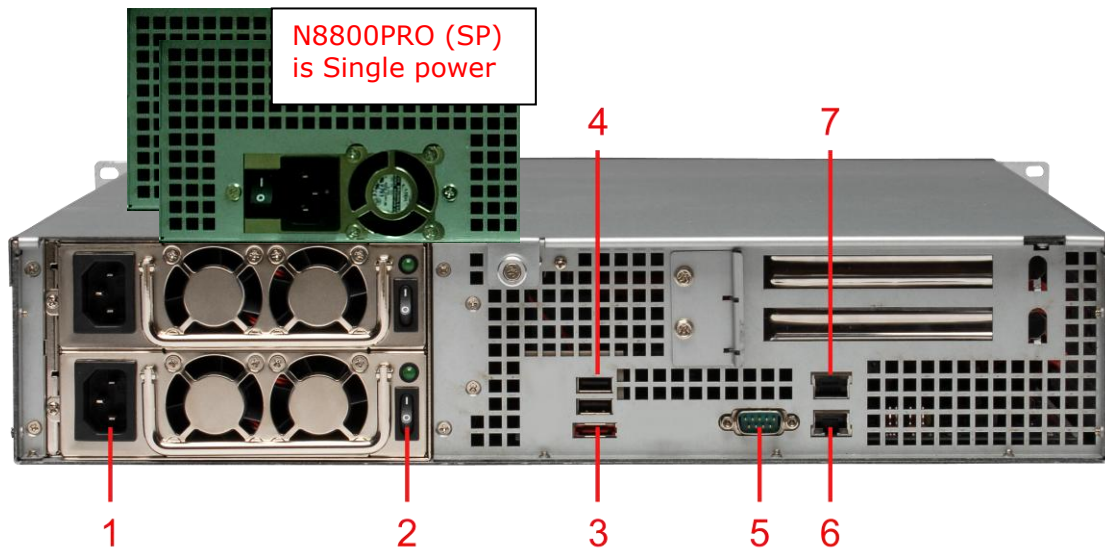

Back Panel	
Item	Description
1.Power Connector	<ul style="list-style-type: none">• Connect the included power cords to these connectors
2.Power Switch	<ul style="list-style-type: none">• Switch for power supply
3.eSATA Port	<ul style="list-style-type: none">• eSATA port for high-speed storage expansion
4.USB Port	<ul style="list-style-type: none">• USB 2.0 port for compatible USB devices, such as USB disks, and USB printers
5.Serial Port	<ul style="list-style-type: none">• This port is for external UPS device
6.WAN/LAN1 Port	<ul style="list-style-type: none">• WAN/LAN1 port for connecting to an Ethernet network through a switch or router
7.LAN2 Port	<ul style="list-style-type: none">• WAN/LAN1 port for connecting to an Ethernet network through a switch or router

Chapter 2: Hardware Installation

Overview

Your Thecus IP storage is designed for easy installation. To help you get started, the following chapter will help you quickly get your Thecus IP storage up and running. Please read it carefully to prevent damaging your unit during installation.

Before You Begin

Before you begin, be sure to take the following precautions:

1. Read and understand the **Safety Warnings** outlined in the beginning of the manual.
2. If possible, wear an anti-static wrist strap during installation to prevent static discharge from damaging the sensitive electronic components on the Thecus IP storage.
3. Be careful not to use magnetized screwdrivers around the Thecus IP storage's electronic components.

Cable Connections

To connect the N2200XXX to your network, follow the steps below:

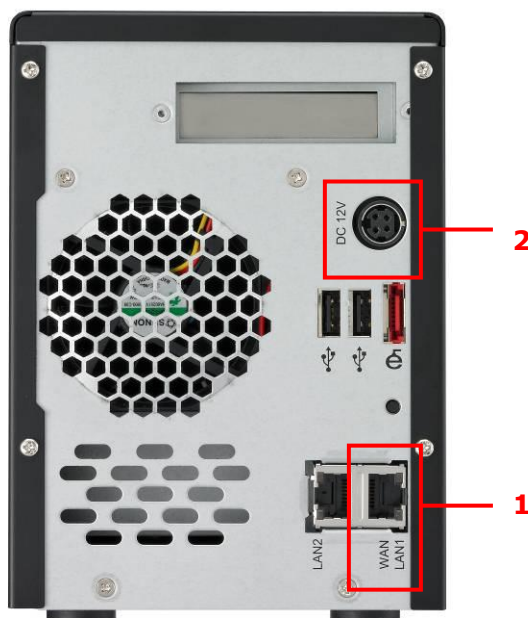

1. Connect an Ethernet cable from your network to the WAN/LAN1 port on the back panel of the N2200XXX.
2. Connect the provided power cord into the power socket on the back panel. Plug the other end of the cord into a surge protected socket.



3. Press the power button to boot the N2200XXX.

To connect the N3200XXX/N0503 to your network, follow the steps below:

1. Connect an Ethernet cable from your network to the WAN/LAN1 port on the back panel of the N3200XXX/N0503.



2. Connect the provided power cord into the power socket on the back panel. Plug the other end of the cord into a surge protected socket.

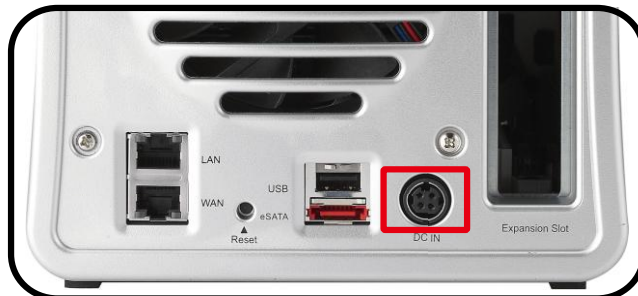

3. Open the front door then press the power button to boot up the N3200XXX/N0503.



Make the following connections on the Thecus N4100PRO and then power up the unit:

1. Connect an Ethernet cable from your network to the WAN port on the back panel of the N4100PRO.
2. Connect the provided power cord into the universal power socket on the back panel. Plug the other end of the cord into a surge protected socket.
3. Press the power button on the front panel to power on the N4100PRO.

Checking System Status

After making connections on the N4100PRO and powering up, check whether the system status is normal or has trouble by observing indicators on the front panel and hard disk trays.

System Status Normal

The system status is normal if:

1. The front panel Power LED glows blue and the WAN LED glows or blinks green.
2. The HDD Power LED on each HDD tray glows blue.

System Trouble

The system has trouble if:

1. Any LED glows red.
1. The system emits a continuous beeping sound.

If the system has trouble, please refer to **Chapter 8: Troubleshooting**.

WARNING

There are no user serviceable parts inside the N4100PRO. Please contact

To connect N4200 series NAS to your network, follow the steps below:

1. Connect an Ethernet cable from your network to the WAN/LAN1 port on the back panel of the N4200.



2. Connect the provided power cord into the universal power socket on the back panel. Plug the other end of the cord into a surge protected socket.



3. Press the power button on the Front Panel to boot up the N4200.



To connect the N5200XXX/N5500 to your network, follow the steps below:

1. Connect an Ethernet cable from your network to the WAN/LAN1 port on the back panel of the N5200XXX/N5500.



2. Connect the provided power cord into the universal power socket on the back panel. Plug the other end of the cord into a surge protected socket. Press the power supply switch to turn on the power supply.

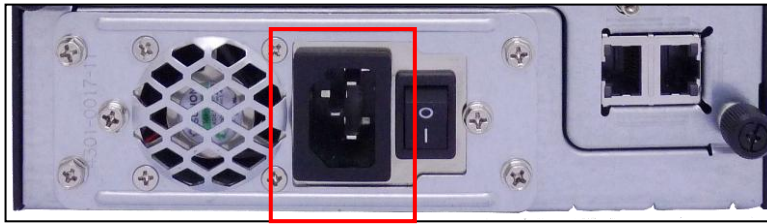

3. Press the power button on the front panel to boot up the N5200XXX/N5500.



To connect the 1U4200XXX/1U4600 to your network, follow the steps below:

1. Connect an Ethernet cable from your network to the WAN/LAN1 port on the back panel of the 1U4200XXX/1U4600.



2. Connect the provided power cord into the universal power socket on the back panel. Plug the other end of the cord into a surge protected socket. Press the power supply switch to turn on the power supply.

NOTE

If you are installing the 1U4200XXXR/1U4600R, be sure to connect both power cables. If you do not, the system will assume one power supply has failed, and an alarm will sound.



3. Press the power button on the front panel to boot up the 1U4200XXX/1U4600.



To connect N7700 series NAS to your network, follow the steps below:

1. Connect an Ethernet cable from your network to the WAN/LAN1 port on the back panel of the N7700.



2. Connect the provided power cord into the universal power socket on the back panel. Plug the other end of the cord into a surge protected socket. Press the power supply switch to turn on the power supply.



3. Press the power button on the Front Panel to boot up the N7700.



To connect N8200XXX/N8800 series NAS to your network, follow the steps below:

1. Connect an Ethernet cable from your network to the WAN/LAN1 port on the back panel of the N8200XXX/N8800.

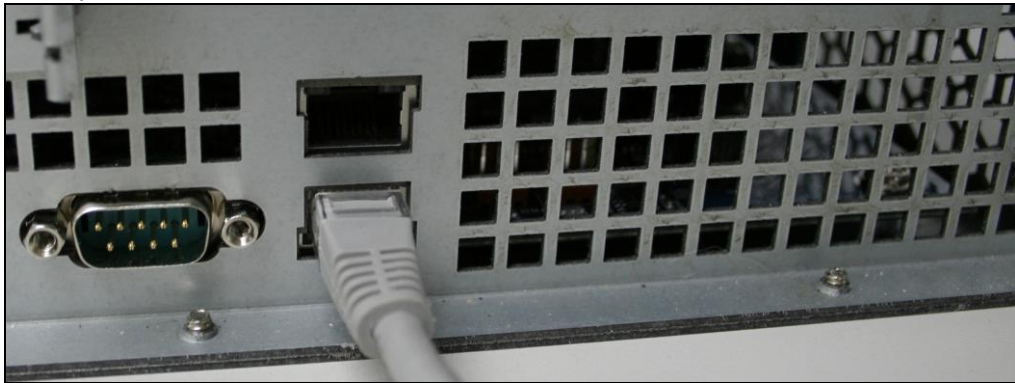

2. Connect the provided power cord into the universal power socket on the back panel. Plug the other end of the cord into a surge protected socket. Press the power supply switch to turn on the power supply.



3. Press the power button on the front panel to boot up the N8200XXX/N8800.



Chapter 3: First Time Setup

Overview

Once the hardware is installed, physically connected to your network, and powered on, you can configure the Thecus IP storage so that it is accessible to your network users. There are two ways to set up your Thecus IP storage: using the **Thecus Setup Wizard** or the **LCD display**. Follow the steps below for initial software setup.

Thecus Setup Wizard

The handy Thecus Setup Wizard makes configuring Thecus IP storage a snap. To configure the Thecus IP storage using the Setup Wizard, perform the following steps:

1. Insert the installation CD into your CD-ROM drive (the host PC must be connected to the network).
2. The Setup Wizard should launch automatically. If not, please browse your CD-ROM drive and double click on **Setup.exe**.



NOTE

For MAC OS X users, double click on Thecus Setup Wizard .dmg file.

3. The Setup Wizard will start and automatically detect all Thecus storage devices on your network. If none are found, please check your connection and refer to **Chapter 7: Troubleshooting** for assistance.



4. Select the Thecus IP storage that you like to configure.

5. Login with the administrator account and password. The default account and password are both "admin".



6. Name your Thecus IP storage and configure the network IP address. If your switch or router is configured as a DHCP Server, configuring the Thecus IP storage to automatically obtain an IP address is recommended. You may also use a static IP address and enter the DNS Server address manually.



7. Change the default administrator password.



- Finished! Access the Thcus IP storage Web Administrator Interface by pressing the **Start Browser** button. You can also configure another Thcus IP storage at this point by clicking the **Setup Other Device** button. Press **Exit** to exit the wizard.



NOTE

The Thcus Setup Wizard is designed for installation on systems running Windows XP/2000/vista/7 or Mac OSX or later. Users with other operating systems will need to install the Thcus Setup Wizard on a host machine with one of these operating systems before using the unit.

LCD Operation (N4100PRO/N5200XXX/N5500/1U4200XXX/1U4600/N7700 series/N8200XXX/N8800 series)

The mentioned models above are equipped with an LCD on the front for easy status display and setup. There are four buttons on the front panel to control the LCD functions.

LCD Controls

Use the **Up** (▲), **Down** (▼), **Enter** (↵) and **Escape** (ESC) keys to select various configuration settings and menu options for Thcus IP storage configuration.

The following table illustrates the keys on the front control panel:

LCD Controls

Icon	Function	Description
▲	Up Button	Select the previous configuration settings option.
▼	Down Button	USB copy confirmation display.
↵	Enter	Enter the selected menu option, sub-menu, or parameter setting.
ESC	Escape	Escape and return to the previous menu.

There are two modes of operation for the LCD: **Display Mode** and **Management Mode**.

Display Mode

During normal operation, the LCD will be in **Display Mode**.

Display Mode	
Item	Description
Host Name	Current host name of the system.
WAN/LAN1	Current WAN/LAN1 IP setting.
LAN2	Current LAN2 IP setting.
Link Aggregation	Current Link Aggregation status
System Fan1	Current system fan1 status.
System Fan2	Current system fan2 status.
CPU Fan	Current CPU fan status
2009/05/22 12:00	Current system time.
Disk Info	Current status of disk slot has been installed
RAID	Current RAID status.

The Thecus IP storage will rotate these messages every one-two seconds on the LCD display.

USB Copy

The USB Copy function enables you to copy files stored on USB devices such as USB disks and digital cameras to the Thecus IP storage by press button. To use USB copy, follow the steps below:

1. Plug your USB device into an available USB port on the Front end.
2. In **Display Mode**, press the **Down Button** (▼).
3. The LCD will display "USB Copy?"
4. Press **Enter** (↵) and the Thecus IP storage will start copying USB disks connected to the front USB port.
5. All of data will be copied into system folder named "USB copy".

Management Mode

During setup and configuration, the LCD will be in **Management Mode**.

To enter into Management Mode, press **Enter** (↵) and an "Enter Password" prompt will show on the LCD.

At this time, the administrator has to enter the correct LCD password. System will check whether the correct LCD password has been entered. The default LCD password is "0000". If correct password is entered, you will enter into the **Management Mode** menu.

Management Mode	
Item	Description
WAN/LAN1 Setting	IP address and netmask of your WAN/LAN1 ports.
LAN2 Setting	IP address and netmask of your LAN2 ports.
Link Agg. Setting	Select Load Balance , 802.3ad or Failover .
Change Admin Passwd	Change administrator's password for LCD operation.
Reset to Default	Reset system to factory defaults.
Exit	Exit Management Mode and return to Display Mode .

NOTE

You can also change your LCD password using the Web Administration Interface by navigating to **System Management > Administrator Password**. For more on the Web Administration Interface, see **Chapter 4: System Management**.

LCD Operation (N3200XXX/N0503)

LCD Controls

Use the **Down** (▼), **Up** (▲), **Enter** (↵) and **Escape** (ESC) keys to operate LCD to view system information and USB copy.

The following table illustrates the keys on the front control panel:

LCD Controls		
Icon	Function	Description
▼	Down Button	Select the previous configuration settings option.
▲	Up Button	Select the next configuration settings option.
↵	Enter	Enter to display USB copy operation.
ESC	Escape	Escape to give up USB copy. Press and hold for 3 seconds to turn off the LCD's backlight. Press any button to switch the backlight back on.

Display Mode

During normal operation, the LCD will be in **Display Mode**.

Display Mode	
Item	Description
Host Name	Current host name of the system.
WAN/LAN1	Current WAN/LAN1 IP setting.
LAN2	Current LAN2 IP setting.
RAID	Current RAID status.
System Fan	Current system fan status.
Temperature	Current system temperature.
Date/Time	Current system date and time
Up Time	The system power on time since last start

The N3200XXX/N0503 will rotate these messages every three seconds on the LCD display.

NOTE

If the RAID array is in a degraded state, the LCD display will be stopped in display mode and show which disk is degraded in the array:

RAID: Degraded [Disk #]

USB Copy

The USB Copy function enables you to copy files stored on USB devices such as USB disks and digital cameras to the N3200XXX/N0503 with a press of a button. To use USB copy, follow the steps below:

1. Plug your USB device into an available USB port on the Front Panel.
2. In **Display Mode**, press the **Enter** (↵).
3. The LCD will display "USB Copy?"

4. Press **Enter** (↵) and the N3200XXX/N0503 will start copying USB disks connected to the front USB port. The LCD will display the USB copy progress and results.

OLED Operation (N4200 series)

OLED Operation

The mentioned models above are equipped with an OLED on the front for easy status display and setup. There are four buttons on the front panel to control the OLED functions.

OLED Controls

Use the **Up** (▲), **Down** (▼), **Enter** (↵) and **Escape** (ESC) keys to select various configuration settings and menu options for N4200series configuration.

The following table illustrates the keys on the front control panel:

OLED Controls		
Icon	Function	Description
▲	Up Button	Select the previous configuration settings option.
▼	Down Button	USB copy confirmation display.
↵	Enter	Enter the selected menu option, sub-menu, or parameter setting.
ESC	Escape	Escape and return to the previous menu.

There are two modes of operation for the OLED: **Display Mode** and **Management Mode**.

Display Mode

During normal operation, the OLED will be in **Display Mode**.

Display Mode	
Item	Description
Host Name	Current host name of the system.
WAN/LAN1	Current WAN/LAN1 IP setting.
LAN2	Current LAN2 IP setting.
Link Aggregation	Current Link Aggregation status
System Fan	Current system fan status.
CPU Fan	Current CPU fan status
2009/05/22 12:00	Current system time.
RAID	Current RAID status.

The N4200 series will rotate these messages every one-two seconds on the OLED display.

Typical Setup Procedure

From the Web Administration Interface, you can begin to setup your Thecus IP storage for use on your network. Setting up the Thecus IP storage typically follows the five steps outlined below.

For more on how to use the Web Administration Interface, see **Chapter 4: [Web Administration Interface](#)**.

Step 1: Network Setup

From the Web Administration Interface, you can configure the network settings of the Thecus IP storage for your network. You can access the **Network** menu from the menu bar.

For details on how to configure your network settings, refer to **Chapter 4: [System Network](#)** .

Step 2: RAID Creation

Next, administrators can configure their preferred RAID setting and build their RAID volume. You can access RAID settings from the menu bar of the Web Administration Interface by navigating to **Storage Management > RAID Configuration**.

For more information on configuring RAID, see **Chapter 4: [System Management > RAID Configuration](#)**.

Don't know which RAID level to use? Find out more about the different RAID levels from **[Appendix B: RAID Basics](#)**.

Step 3: Create Local Users or Setup Authentication

Once the RAID is ready, you can begin to create local users for Thecus IP storage, or choose to setup authentication protocols such as Active Directory (AD).

For more on managing users, go to **Chapter 4: [User and Group Authentication](#)**.

For more information on configuring Active Directory, see **Chapter 4: [User and Group Authentication > ADS/NT Support](#)**.

For information about the benefits of Active Directory, see **[Appendix C: Active Directory Basics](#)**.

Step 4: Create Folders and Set Up ACLs

Once users are introduced into your network, you can begin to create various folders on the Thecus IP storage and control user access to each using Folder Access Control Lists.

More information on managing folders, see **Chapter 4: [Storage Management > Share Folder](#)** .

To find out about configuring Folder Access Control Lists, see **Chapter 4: [Storage Management > Share Folder > Folder Access Control List \(ACL\)](#)**.

Step 5: Start Services

Finally, you can start to setup the different services of Thecus IP storage for the users on your network. You can find out more about each of these services by clicking below:

SMB/CIFS

Apple File Protocol (AFP)

Network File System (NFS)

File Transfer Protocol (FTP)

iTunes Server

Printer Server

Photo Server

Chapter 4: System Administration

Overview

The Thcus IP storage provides an easily accessible **Web Administration Interface**. With it, you can configure and monitor the Thcus IP storage anywhere on the network.

Web Administration Interface

Make sure your network is connected to the Internet. To access Thcus IP storage **Web Administration Interface**:

1. Type the Thcus IP storage IP address into your browser. (Default IP address is `http://192.168.1.100`)

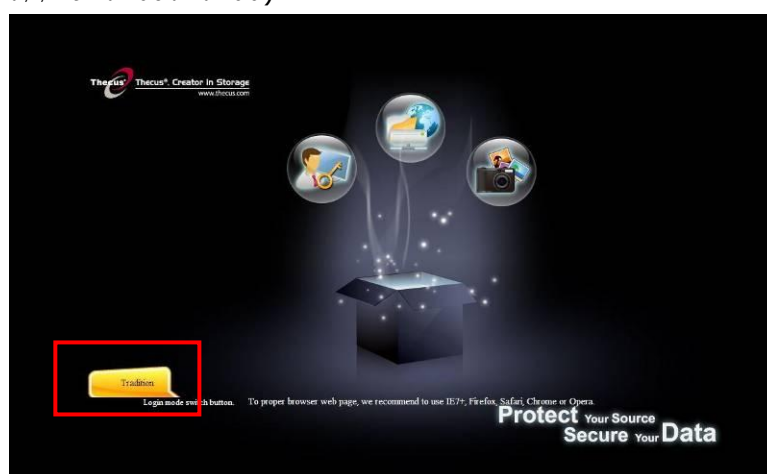

NOTE

Your computer's network IP address must be on the same subnet as the Thcus IP storage. If the Thcus IP storage has default IP address of 192.168.1.100, your managing PC IP address must be 192.168.1.x, where x is a number between 1 and 254, but not 100.

NOTE

This page can be displayed with Flash or with HTML. Choose **Flash** for Flash (shown in the top figure) and **Traditional** for HTML (shown in the bottom figure).

2. Login to the system using the administrator user name and password. The factory defaults are:

User Name: admin

Password: admin

- ※ If you changed your password in the setup wizard, use the new password.

Once you are logged in as an administrator disclaimer page will appear as below. Please click the check box if you do not want to have this page displayed during the next login.

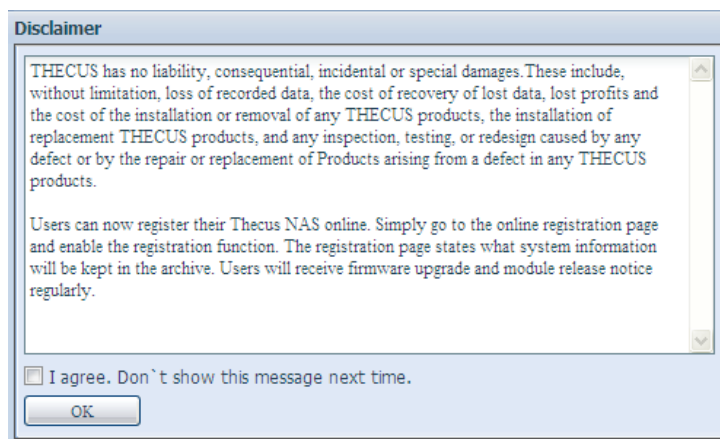

Following by disclaim page, you will see the **Web Administration Interface**. From here, you can configure and monitor virtually every aspect of the Thecus IP storage from anywhere on the network.

My Favorite

The user interface with "My Favorite" shortcut is allowed user to designate often used items and have them display on the main screen area. The figure below displays 12 default favorite functions.

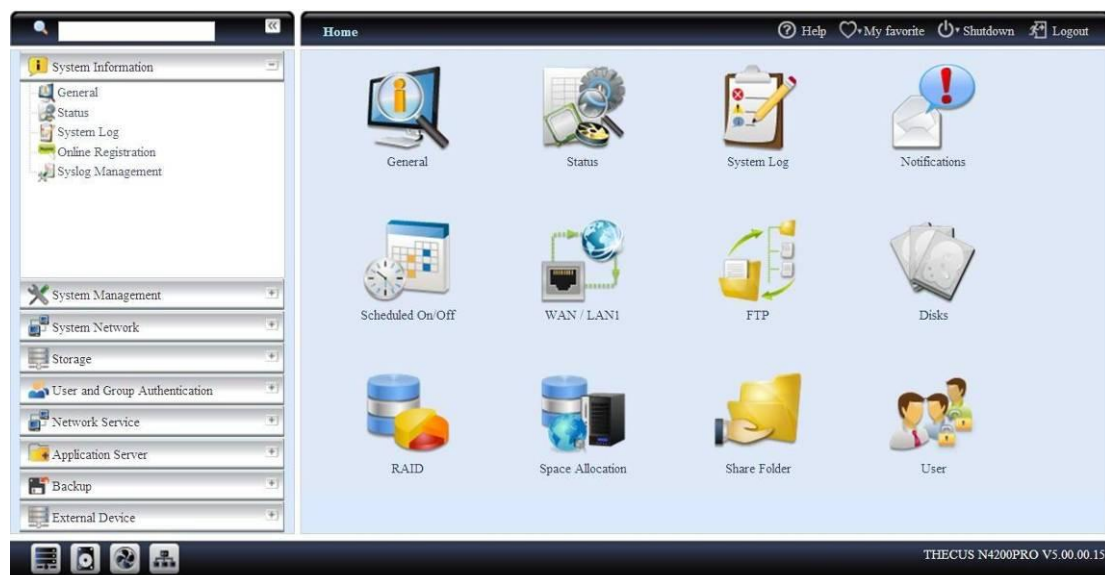

Administrators can add or remove favorite functions to My Favorites by right clicking the mouse on the menu tree.



The other way administrators can add favorite functions is by clicking the "Add Favorite" icon in each function screen. Please refer figure below in red circuit icon.

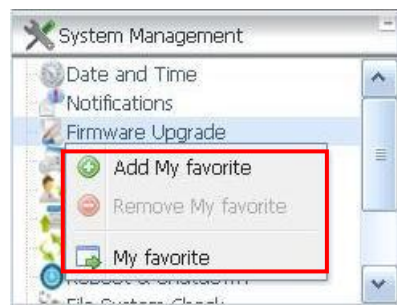

To return to the favorite screen, simply click "Home" located at the left hand corner of the main screen.



Menu Bar

The **Menu Bar** is where you will find all of the information screens and system settings of Thecus IP storage. The various settings are placed in the following groups on the menu bar:

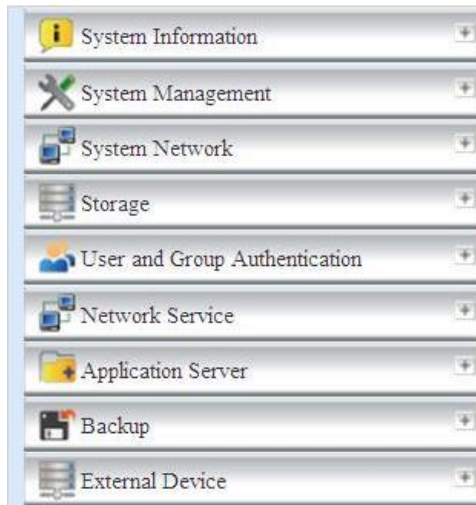

Menu Bar	
Item	Description
System Information	Current system status of the Thecus IP storage.
System Management	Various Thecus IP storage system settings and information.
System Network	Information and settings for network connections, as well as various services of the Thecus IP storage.
Storage	Information and settings for storage devices installed into the Thecus IP storage.
User and Group Authentication	Allows configuration of users and groups.
Network Service	Setup and manage protocols such as Samba/CIFS, AFP, NFS, FTP, and other network services.
Application Server	Printer Server and iTunes Server to set up of the Thecus IP storage.
Backup	Category of Backup Features set up of the Thecus IP storage.
External Device	Thecus IP storage support printer serving and UPS backup power supplies.





Moving your cursor over any of these items will display the dropdown menu selections for each group.

In the following sections, you will find detailed explanations of each function, and how to configure your Thecus IP storage.

Message Bar

You can get information about system status quickly by moving mouse over.



Message Bar		
Item	Status	Description
	RAID Information.	Display the status of created RAID volume. Click to go to RAID information page as short cut.
	Disks Information.	Display the status of disks installed in the system. Click to go to Disk information page as short cut.
	FAN.	Display system FAN Status. Click to go to System Status page as short cut.
	Network.	Green: The system is connected to the Internet. Red: The system is unable to connect to the Internet.



- **Web Disk**

Click this to log into the Web Disk.

- **Photos**

Click this to log into the photo server.

- **News**

Accesses online registration and the latest release news.

- **Log**

Accesses the system log. New logs will be displayed with an icon here.

- **Language Selection**

The Thecus IP storage supports multiple Languages, including:

English,Japanese,Traditional Chinese,Simplified Chinese,French,German,Italian, Korean,Spanish,Russia,Polish,Portugal

On the menu bar, click Language and the selection list appears. This user interface will switch to selected Language for Thecus IP storage.

- **Help**

Click this to toggle the help page open and browse or search through the UI help database. The current page's help section will be displayed first.

- **My Favorite**

Add/Remove the current page from the Home page.

- **Shutdown**

Choose **Shutdown** or **Reboot** from the dropdown menu to shutdown or reboot your NAS.

- **Logout**

Click to log out of Web Administration Interface.

System Information

Information provides viewing on current Product info, System Status, Service Status and Logs.

The menu bar allows you to see various aspects of the Thecus IP storage. From here, you can discover the status of the Thecus IP storage, and also other details.

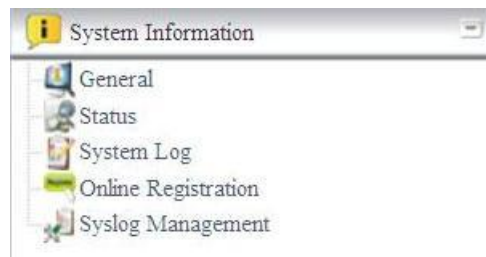

General Information

Once you login, you will first see the basic **Product Information** screen providing **Manufacturer**, **Product No.**, **Firmware Version**, and **System Up Time** information.

Product Information	
Manufacturer	Thecus
Product No.	N4200PRO
Firmware Version	5.00.00.15
Up Time	3 hours 8 minutes

Product Information	
Item	Description
Manufacturer	Displays the name of the system manufacturer.
Product No.	Shows the model number of the system.
Firmware version	Shows the current firmware version.
Up time	Displays the total run time of the system.

System/Service Status

(N3200XXX/N0503/N4100PRO/N4200series/N5200XXX/N5500/1U4200XXX/1U4600/N7700 series/N2200XXX/N8200XXX/N8800 series)

From the **Status** menu, choose the **System** item, **System Status** and **Service Status** screens appear. These screens provide basic system and service status information.

System Status	
CPU Activity	0%
CPU Fan Speed	OK
System Fan 1 Speed	OK
Up Time	3 hours 10 minutes

Service Status	
AFP Status	Stopped
NFS Status	Stopped
SMB/CIFS Status	Running
FTP Status	Stopped
TFTP Status	Stopped
Nsync Status	Running
UPnP Status	Stopped
SNMP Status	Stopped

System Status	
Item	Description
CPU Loading (%)	Displays current CPU workload of the Thecus IP storage.
CPU Fan Speed	Displays current CPU fan status.
System Fan Speed	Displays the current status of the system fan.
Up Time	Shows how long the system has been up and running.

Service Status	
Item	Description
AFP Status	The status of the Apple Filing Protocol server.
NFS Status	The status of the Network File Service Server.
SMB/CIFS Status	The status of the SMB/CIFS server.
FTP Status	The status of the FTP server.
TFTP Status	The status of the TFTP server.
Nsync Status	The status of the Nsync server.
UPnP Status	The status of the UPnP service.
SNMP	The status of the SNMP service.

Logs

From the **System Information** menu, choose the **Logs** item and the **System Logs** screen appears. This screen shows a history of system usage and important events such as disk status, network information, and system booting. See the following table for a detailed description of each item:

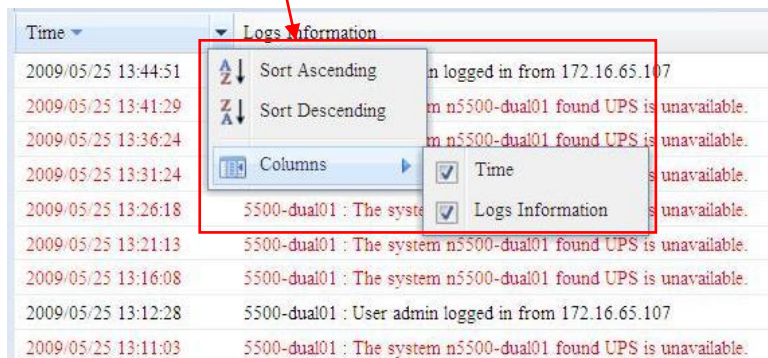
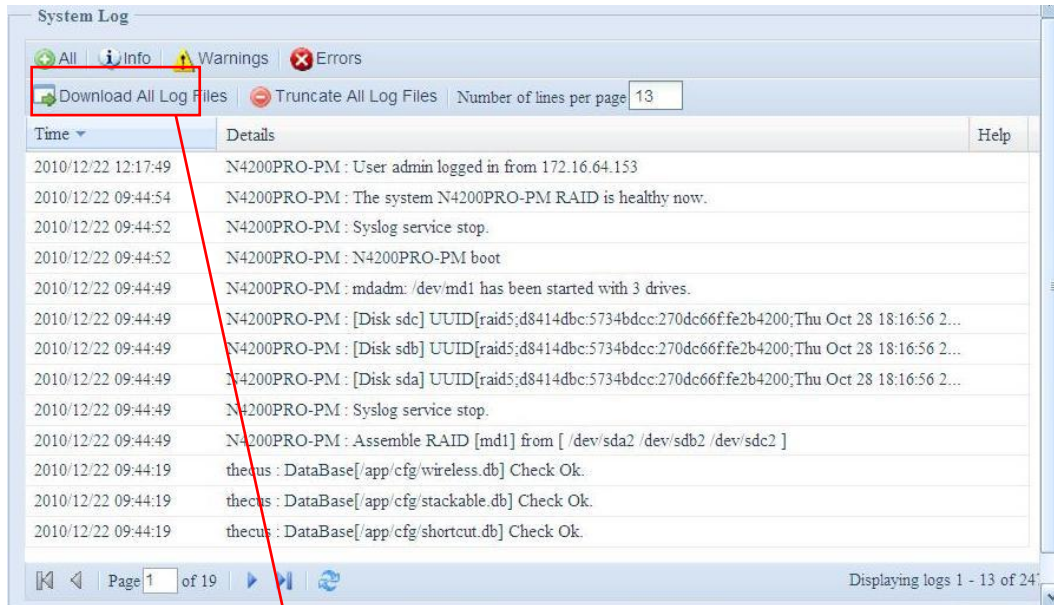

See the following table for a detailed description of each item:

System Logs	
Item	Description
All	Provides all log information including system messages, warning messages and error messages.
INFO	Records information about system messages.
WARN	Shows only warning messages.
ERROR	Shows only error messages.
Download All Log File	Export all logs to an external file.
Truncate All Log File	Clear all log files.
The number of lines per page <input type="text" value="13"/>	Specify desired number of lines to display per page.
Sort Ascending	Shows logs by date in ascending order.
Sort Descending	Shows logs by date in descending order.
<< < > >>	Use the forward (> >>) and backward (<< <) buttons to browse the log pages.
	Re-loading logs.

On-line Register

From the **System Information** menu, choose the **On-line Register** item and the **System On-line Register** screen appears. The on-line register service can periodically update the user when new firmware and software modules are released by Thecus. To enable this service, simply check the "Enable" check box. By enabling this service, the items in bold will be sent to Thecus via the Internet.



Other than the defined items sent upon registration, there are also two additional items: "HDD Info" and "Time Zone". These two optional items can also be sent to Thecus anonymously for analysis and statistics purposes. To send these items, simply check the desired checkboxes to help Thecus improve its products and services.

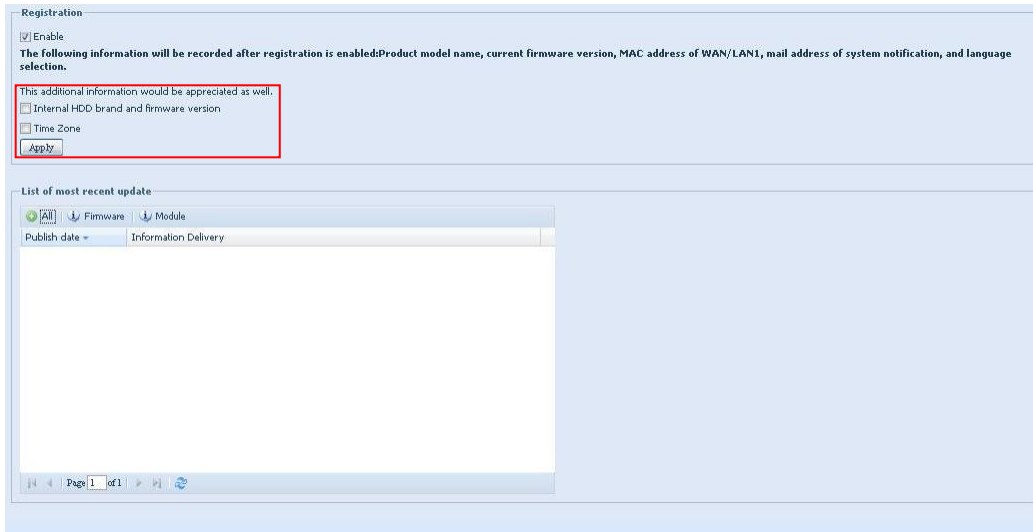

Syslog Management

Generates system log messages for the syslog server. These messages are stored on your NAS in: Nsync > log > messages. Information can be obtained in two ways: locally and remotely.

Local Access - When **Local** is selected, log messages can be viewed directly through samba. However, to access the Nsync folder through samba, the folder must be set as browseable and the user must be given ACL permissions. In OS X, UNIX extensions must be disabled under Network Service > Samba/CIFS in the UI.

Remote Access - They can also be viewed remotely by selecting **Remote** and inputting a **Remote IP Address** into the input field. This will allow a TFTP program, such as TFTPd32, to access the system log remotely from a computer.

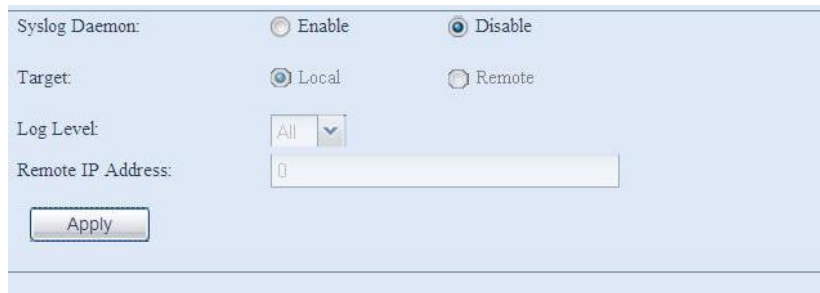

System Management

The **System Management** menu gives you a wealth of settings that you can use to configure your Thecus IP storage system administration functions. You can set up system time, system notifications, and even upgrade firmware from this menu.

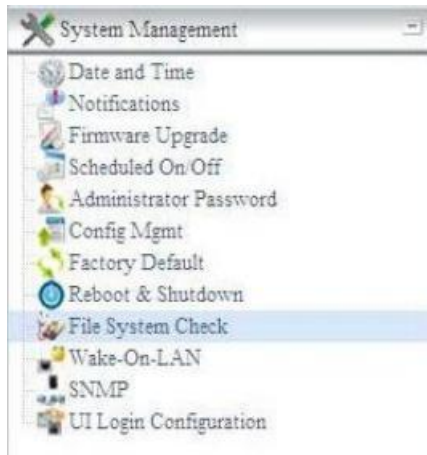

Date and Time: System Date and settings

From the **Date and time** menu, choose the item and the screen appears. Set the desired **Date**, **Time**, and **Time Zone**. You can also elect to synchronize the system time on Thecus IP storage with an **NTP (Network Time Protocol) Server**.

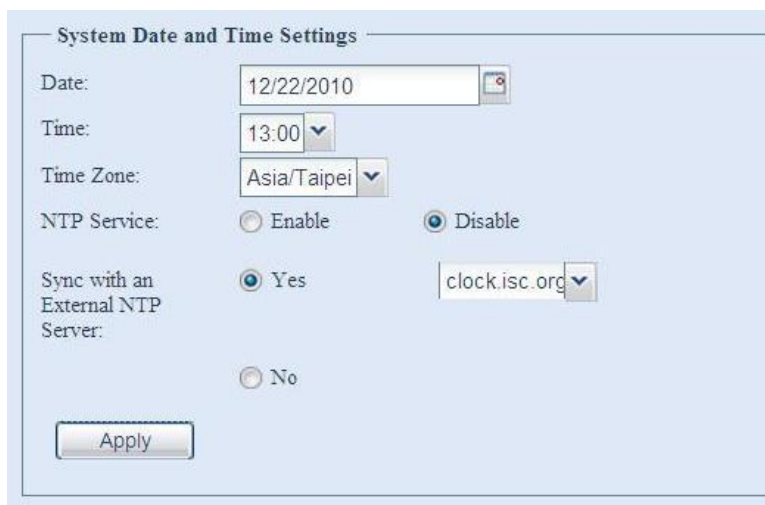

See the following table for a detailed description of each item:

Time	
Item	Description
Date	Sets the system date.
Time	Sets the system time.
Time Zone	Sets the system time zone.
NTP Server	Select Enable to synchronize with the NTP server. Select Disable to close the NTP server synchronization.
Sync with external NTP Server	Select YES to allow Thecus IP storage to synchronize with an NTP server of your choice. Press Apply to change.

WARNING

If an NTP server is selected, please make sure your Thecus IP storage has been setup to access the NTP server.

Notification configuration

From the menu, choose the **Notification** item, and the **Notification Configuration** screen appears. This screen lets you have Thecus IP storage notify you in case of any system malfunction. Press **Apply** to confirm all settings. See following table for a detailed description of each item.

Notification Configuration	
Item	Description
Beep Notification	Enable or disable the system beeper that beeps when a problem occurs.
Email Notification	Enable or disable email notifications of system problems.
SMTP Server	Specifies the hostname/IP address of the SMTP server.
Port	Specifies the port to send outgoing notification emails.
Auth Type	Select the SMTP Server account authentication type.
SMTP Account ID	Set the SMTP Server Email account ID.
Account Password	Enter a new password.
E-mail From	Set email address to send email.
Receiver's E-mail Address (1,2,3,4)	Add one or more recipient's email addresses to receive email notifications.

NOTE

Consult with your mail server administrator for email server information.

Firmware Upgrade

From the menu, choose the **Firmware Upgrade** item and the **Firmware Upgrade** screen appears.

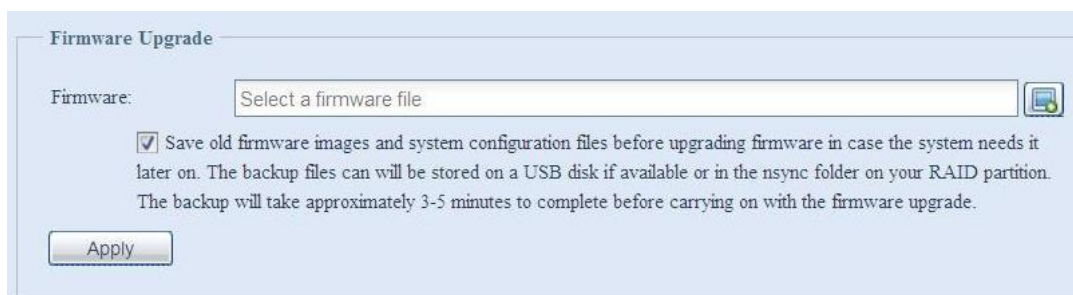

Follow the steps below to upgrade your firmware:

1. Use the **Browse** button  to find the firmware file.
2. Press **Apply**.
3. The beeper beeps and the Busy LED blinks until the upgrade is complete.

NOTE

- The beeper only beeps if it is enabled in the System Notification menu.
- Check Thecus website for the latest firmware release and release notes.
- Downgrading firmware is not permitted.

WARNING

Do not turns off the system during the firmware upgrade process.
This will lead to a catastrophic result that may render the system inoperable.

NOTE

- Save old firmware images and system configuration files before upgrading firmware in case the system needs it later on. The backup files can will be stored on a USB disk if available or in the nsync folder on your RAID partition. The backup will take approximately 3-5 minutes to complete before carrying on with the firmware upgrade.

Schedule Power On/Off

Using the Thecus IP storage System Management, you can save energy and money by scheduling the Thecus IP storage to turn itself on and off during certain times of the day.

From the menu, choose the **Schedule Power On/Off** item and the **Schedule Power On/Off** screen appears.

To designate a schedule for the Thecus IP storage to turn on and off, first enable the feature by checking the **Enable Schedule Power On/Off** checkbox.

Then, simply choose an on and off time for each day of the week that you would like to designate a schedule by using the various dropdowns.

Finally, click **Apply** to save your changes.

On/Off Schedule

Enable Scheduled On/Off

	Action	Time	Action	Time
Sunday:	None	00:00	None	00:00
Monday:	None	00:00	None	00:00
Tuesday:	None	00:00	None	00:00
Wednesday:	None	00:00	None	00:00
Thursday:	None	00:00	None	00:00
Friday:	None	00:00	None	00:00
Saturday:	None	00:00	None	00:00

Apply

Example - Monday: On: 8:00; Off: 16:00

System will turn on at 8:00 AM on Monday, and off at 16:00 on Monday. System will turn on for the rest of the week.

If you choose an on time, but do not assign an off time, the system will turn on and remain on until a scheduled off time is reached, or if the unit is shutdown manually.

Example - Monday: On: 8:00

System will turn on at 8:00 AM on Monday, and will not shut down unless powered down manually.

You may also choose two on times or two off times on a particular day, and the system will act accordingly.

Example - Monday: Off: 8:00; Off: 16:00

System will turn off at 8:00 AM on Monday. System will turn off at 16:00 PM on Monday, if it was on. If the system was already off at 16:00 PM on Monday, system will stay off.

Administrator password

From the menu, choose the **Administrator Password** item and the **Change Administrator Password** screen appears. Enter a new password in the **New Password** box and confirm your new password in the **Confirm Password** box. Press **Apply** to confirm password changes.

There is also **password** for enter **LCD** setting you could setup here. Enter a new password in the **New Password** box and confirm your new password in the **Confirm Password** box. Press **Apply** to confirm password changes.

The image shows two separate form sections. The top section is titled 'Change Administrator Password' and contains two text input fields labeled 'New Password' and 'Confirm Password', with an 'Apply' button below them. The bottom section is titled 'Change OLED Display Password' and also contains two text input fields labeled 'New Password' and 'Confirm Password', with an 'Apply' button below them.

See the following table for a detailed description of each item.

Change Administrator and LCD Entry Password	
Item	Description
New Password	Type in a new administrator password.
Confirm Password	Type the new password again to confirm.
Apply	Press this to save your changes.

Config Mgmt

From the menu, choose the **Config Mgmt** item and the **System Configuration Download/Upload** screen appears. From here, you can download or upload stored system configurations.

The image shows a screen titled 'System Configuration Download/Upload'. It has an 'Upload:' label followed by a text input field containing the placeholder text 'Please choose a file to upload.' and a folder icon button. Below the input field are two buttons labeled 'Upload' and 'Download'.

See the following table for a detailed description of each item.

System Configuration Download/Upload	
Item	Description
Download	Save and export the current system configuration.
Upload	Import a saved configuration file to overwrite current system configuration.

NOTE

Backing up your system configuration is a great way to ensure that you can revert to a working configuration when you are experimenting with new system settings. The system configuration you have backup can be only restore in same firmware version. And the backup details have excluded user/group accounts.

Factory default

From the menu, choose the **Factory Default** item and the **Reset to Factory Default** screen appears. Press **Apply** to reset Thecus IP storage to factory default settings.



WARNING

Resetting to factory defaults will not erase the data stored in the hard disks, but **WILL** revert all the settings to the factory default values.

Reboot & Shutdown

From the menu, choose **Reboot & Shutdown** item, and the **Shutdown/Reboot System** screen appears. Press **Reboot** to restart the system or **Shutdown** to turn the system off.



File System check

The File System Check allows you to perform a check on the integrity of your disks' file system. Under the menu, click **File system Check** and the **File System Check** prompt appears.

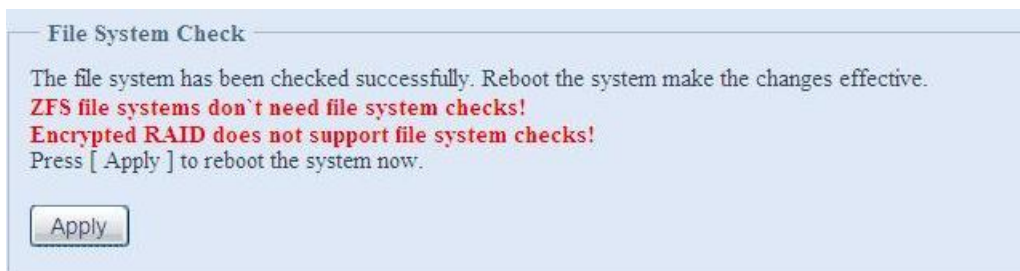

To perform a file system check, click **Apply**.

Once clicked, the following prompt will appear:

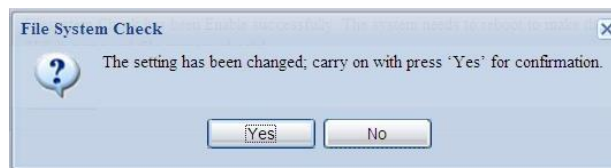

Click **Yes** to reboot the system.

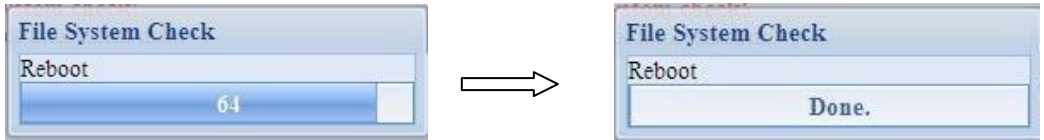

Once the system has rebooted, you will be returned to the **File System Check** prompt. There you will see the available RAID volumes to run the file system check on except ZFS volume, ZFS has no need to perform file system check. Check the desired RAID volumes and click **Next** to proceed with the file system check. Click **Reboot** to reboot without running the check.

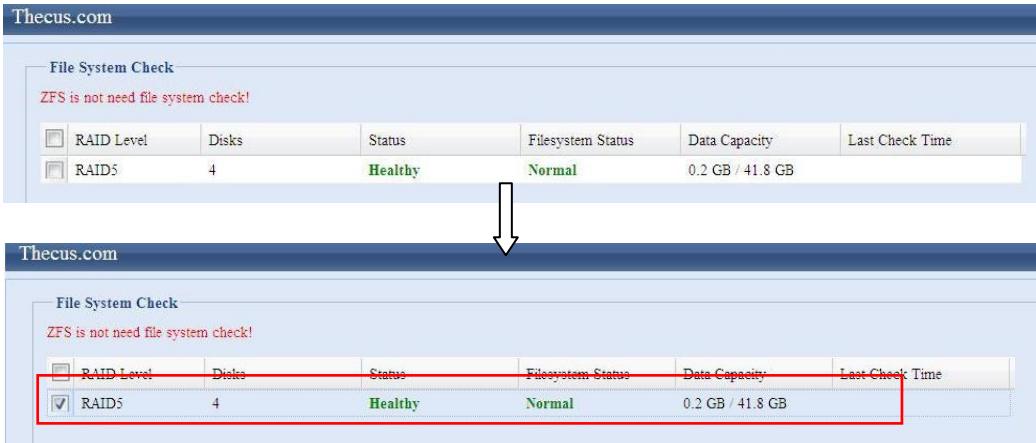

Once you click **Next**, you will see the following screen:

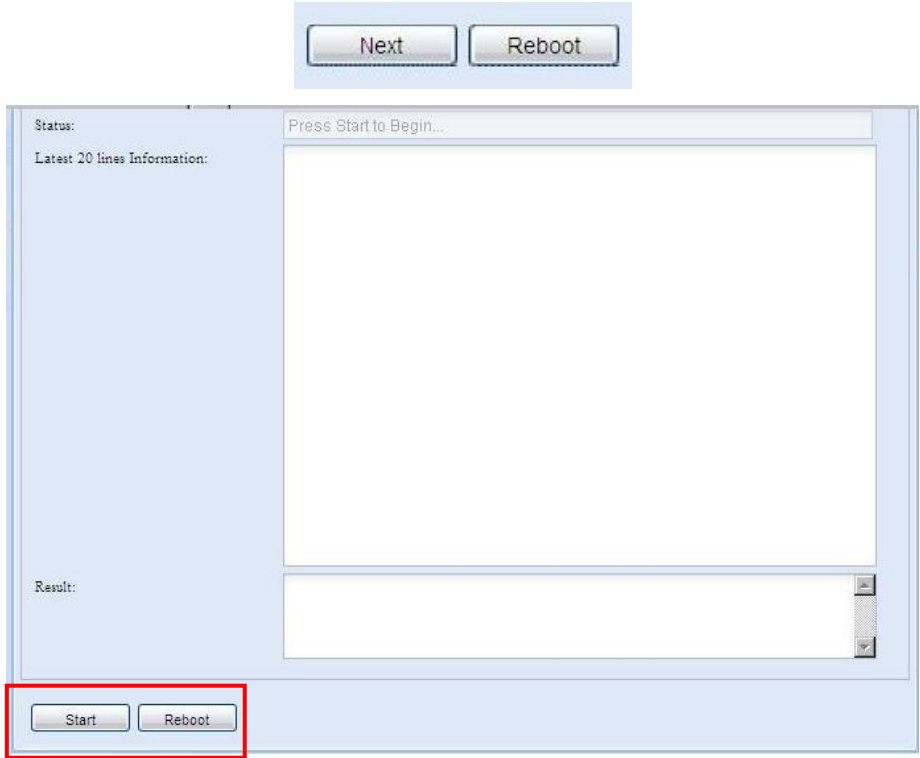

Click **Start** to begin the file system check. Click **Reboot** to reboot the system. When the file system check is run, the system will show 20 lines of information until it is complete. Once complete, the results will be shown at the bottom.

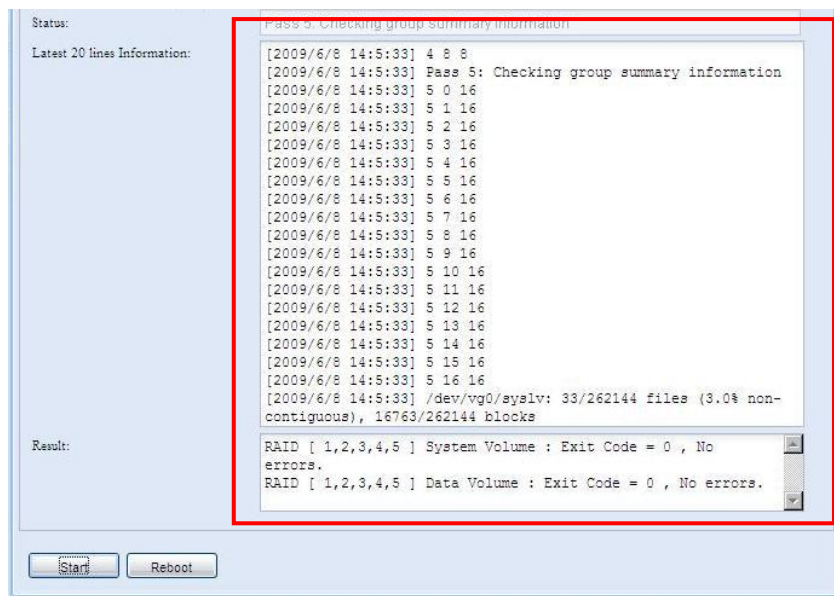

NOTE The system must be rebooted before Thecus IP storage can function normally after file system check complete.

Wake-Up On LAN (WOL)

The Thecus IP storage has the ability to be awoken from sleep mode via WAN/LAN1 port.

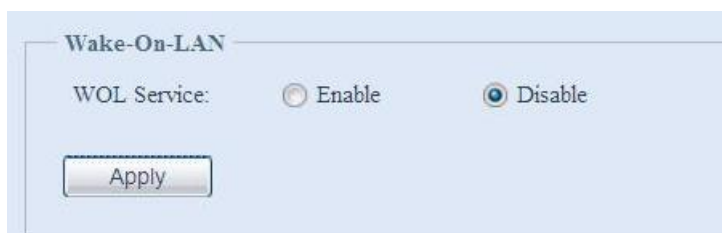

From the menu, choose the **WOL** item, and the **Wake-up On LAN** screen appears. From here, you can **Enable** or **Disable**.

Wake-up On LAN Configuration	
Item	Description
WOL Service	Enable or Disable WOL service
Apply	Click Apply to save changes.

SNMP Support

From the menu, choose the **SNMP** item and the **SNMP Support** screen appears. You could enable the SNMP function and filled in the related information in each fields. With the SNMP management software could get system basic information.



The image shows the 'SNMP Support' configuration window. At the top, it has the title 'SNMP Support'. Below the title, there are two radio buttons: 'Enable' (which is unselected) and 'Disable' (which is selected). Underneath, there are four text input fields labeled 'Read Community:', 'System Contact:', 'System Location:', and 'Trap Target IP:'. To the right of the 'Read Community:' field, there is a red note that says '(Allow: 0~9, a~z, A~Z, -, _)'. At the bottom left of the window, there is an 'Apply' button.

From the menu, choose the **SNMP** item, and the **SNMP Support** screen appears. From here, you can **Enable** or **Disable**.

UI Login Configuration

Adjusts UI Login Configuration settings, you can enable/disable the Web Disk and Photo Server functions, according to your needs. For the 3X series, users need to install the photo server module or web disk module to access these functions.

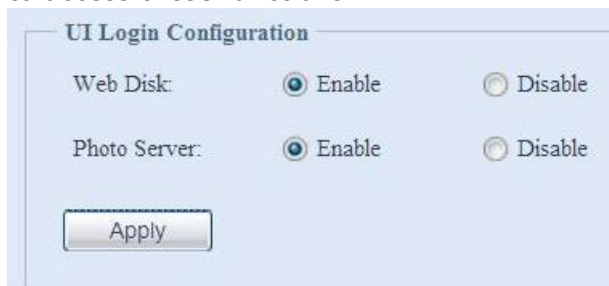

The image shows the 'UI Login Configuration' window. It has the title 'UI Login Configuration'. There are two rows of radio buttons. The first row is for 'Web Disk' with 'Enable' selected and 'Disable' unselected. The second row is for 'Photo Server' with 'Enable' selected and 'Disable' unselected. At the bottom left, there is an 'Apply' button.

System Network

Use the **System Network** menu to make network configuration settings as well as service support settings.

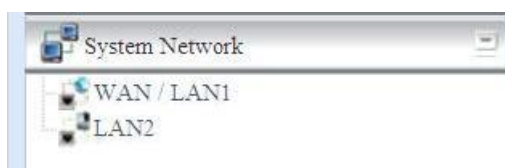

WAN/LAN1

WAN/LAN1 Configuration

From the **System Network** menu, choose **WAN/LAN1**, and the **WAN/LAN1 Configuration** screen appears. This screen displays the network parameters of the WAN/LAN1 connection. You may change any of these items and press **Apply** to confirm your settings. See a description of each item in the following table:

WAN / LAN1 Configuration

Host Name: N4200PRO-PM Domain Name: thecus.com

WINS Server 1: WINS Server 2:

MAC Address: 00:14:FD:14:D6:94

Link Detected: yes

Link Speed: 1000Mbps

Jumbo Frame Support: Disable (Select from drop down list or input manually, allow 1501 ~ 9000)

IP Sharing Mode: Enable Disable

Link Aggregation: Disable

Set IP Address by:

Static Dynamic

IP: 172.16.64.140

Netmask: 255.255.252.0

Gateway: 172.16.66.135

DNS Server: 172.16.66.244
168.95.1.1

Apply

WAN/LAN1 Configuration	
Item	Description
Host name	Host name that identifies the Thecus IP storage on the network.
Domain name	Specifies the domain name of Thecus IP storage.
WINS Server	To set a server name for NetBIOS computer.
MAC Address	MAC address of the network interface.
Jumbo Frame Support	Enable or disable Jumbo Frame Support of the WAN/LAN1 interface on your Thecus IP storage.
IP Sharing Mode	When enabled, PCs connected to the LAN2 port will be able to access the WAN/LAN1.
Link Aggregation	Specifies whether WAN/LAN1 and LAN2 ports will be aggregated and act as one port. There are 6 modes can be choose from: Load Balance/Fail-over/Balance-XOR/802.3ad/Balance-TLB/Balance-ALB
Set IP Address by: Static / Dynamic	You can choose a static IP or Dynamic IP, and input your network configuration
IP	IP address of the WAN/LAN1 interface.
Netmask	Network mask, which is generally: 255.255.255.0
Gateway	Default Gateway IP address.
DNS Server	Domain Name Service (DNS) server IP address.

NOTE

- Only use Jumbo Frame settings when operating in a Gigabit environment where all other clients have Jumbo Frame Setting enabled.
- Enabling DHCP automatically turns on UPnP— see the Service Support Screen.
- If you are only using the WAN/LAN1 port, we suggest that you disable IP Sharing Mode. This will result in higher throughput.
- A correct DNS setting is vital to networks services, such as SMTP and NTP.
- To use the Link Aggregation with "802.3ad selected" feature, please make sure the networking equipment on the other end of Ethernet cable also supports 802.3ad protocol.

WARNING

Most Fast Ethernet (10/100) Switches/Routers do not support Jumbo Frame and you will not be able to connect to your Thcus IP Storage after Jumbo Frame is turned on. If this happens, turn off the Thcus IP Storage. Then, insert USB disk with factory reset utility included and power on the Thcus IP Storage. Till the system power on complete then it will bring your system settings back to factory default.

LAN2

LAN2 Configuration

The Thcus IP storage supports two Gigabit Ethernet ports for higher service availability. To configure these ports, choose **LAN2** from the **System Network** menu, and the **LAN2 Configuration** screen appears. Press **Apply** to save your changes.

LAN2 Configuration	
Item	Description
MAC Address	Displays the MAC address of the LAN2 interface.
Jumbo Frame Support	Enable or disable Jumbo Frame Support on the LAN2 interface.
IP	Specifies the IP address of the LAN2 interface.
Netmask	Specifies the Network Mask of the LAN2 interface.
Gateway	When Thcus NAS as a DHCP server from LAN2, it can have another route to balance traffic bandwidth for its DHCP clients
Link Detected	Specifies the LAN2 port link status
Lick Speed	Specifies the LAN2 port link speed

NOTE

Before enabling Jumbo Frame Support, please make sure your network equipment supports Jumbo Frame. If your equipment is incompatible, you might not be able to connect to your Thcus IP storage.

NOTE

If the IP sharing mode setting is set to "Enable" under WAN/LAN1 port, then this 2nd gateway cannot be configured.

DHCP Server Configuration

A DHCP server can be configured to assign IP addresses to devices connected to the LAN2 port. To configure these ports, choose **LAN2** from the **System Network** menu.

DHCP Configuration	
Item	Description
DHCP Server	Enable or disable the DHCP server to automatically assign IP address to PCs connected to the LAN2 interface.
Start IP	Specifies the starting IP address of the DHCP range.
End IP	Specifies the ending IP address of the DHCP range.
DNS Server	Displayed the DNS server IP address.

NOTE

The IP Segment of WAN/LAN1 and LAN2 should not overlap.

WARNING

The IP address of the LAN2 interface should not be in the range of the Start IP address and End IP address.

Storage Management

The **Storage** menu displays the status of storage devices installed in the Thecus IP storage, and includes storage configuration options such as RAID and disk settings, folder configuration, space allocation and ISO Mount.

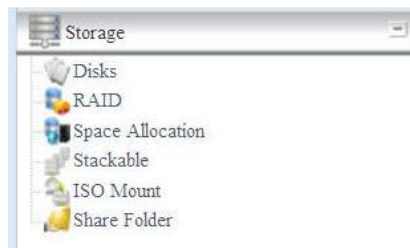

Disks Information

From the **Storage** menu, choose the **Disks** item and the **Disks Information** screen appears. From here, you can see various items about installed SATA hard disks. Blank lines indicate that a SATA hard disk is not currently installed in that particular disk slot.

NOTE

- The screen shot below just example from Thecus IP Storage. The disk slots can from 4 to 8 depend on the model of Thecus IP storage.

Disks Information

Disk No.	Capacity (MB)	Model	Firmware	Status	Bad Block Scan
1	476,940	WDC WD5003ABYX-0	01.0	Detected	▶ Click to start
2	476,940	WDC WD5003ABYX-0	01.0	Detected	▶ Click to start
3	476,940	WDC WD5003ABYX-0	01.0	Detected	▶ Click to start
4	N/A	N/A	N/A	N/A	N/A

Total Capacity: 1430820 (MB)

Disk Power Management

Disk Power Management: Minute

Disks Information	
Item	Description
Disk No.	Indicates disk location.
Capacity	Shows the SATA hard disk capacity.
Model	Displays the SATA hard disk model name.
Firmware	Shows the SATA hard disk firmware version.
Status	Indicates the status of the disk. Can read OK , Warning , or Failed .
Bad Block scan	Yes to start scan Bad Block.
Total Capacity	Shows the total SATA hard disk capacity.
Disk Power Management	The administrator can set the disk to power down after a period of inactivity.

NOTE

When the Status shows Warning, it usually means there are bad sectors on the hard disk. It is shown only as a precaution and you should consider changing the drives.

S.M.A.R.T. Information

On the **Disks Information** screen, the status of each disk will be displayed in the **Status** column. Clicking on an **OK** or **Warning** link will display the **S.M.A.R.T Information** window for that particular disk.

You may also perform disk SMART test, simply to click "Test" to start with. The result is only for reference and system will not take any action from its result.

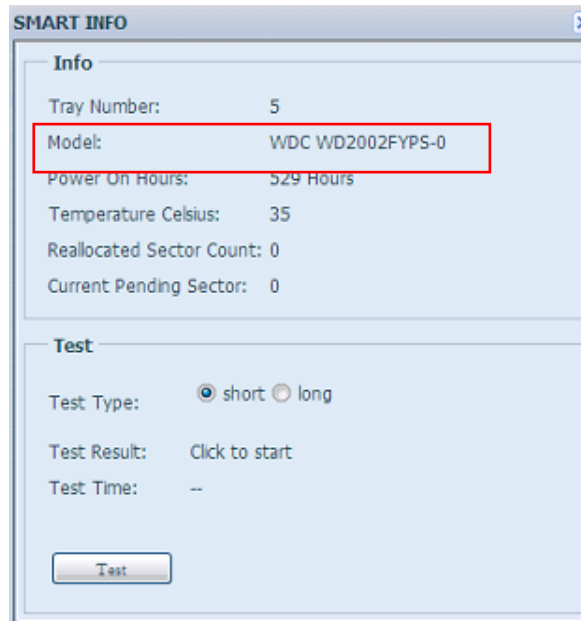

S.M.A.R.T. Information	
Item	Description
Tray Number	Tray the hard disk is installed in.
Model	Model name of the installed hard disk.
Power ON Hours	Count of hours in power-on state. The raw value of this attribute shows total count of hours (or minutes, or seconds, depending on manufacturer) in power-on state.
Temperature Celsius	The current temperature of the hard disk in degrees Celsius
Reallocated Sector Count	Count of reallocated sectors. When the hard drive finds a read/write/verification error, it marks this sector as "reallocated" and transfers data to a special reserved area (spare area). This process is also known as remapping and "reallocated" sectors are called remaps. This is why, on a modern hard disks, you can not see "bad blocks" while testing the surface - all bad blocks are hidden in reallocated sectors. However, the more sectors that are reallocated, the more a decrease (up to 10% or more) can be noticed in disk read/write speeds.
Current Pending Sector	Current count of unstable sectors (waiting for remapping). The raw value of this attribute indicates the total number of sectors waiting for remapping. Later, when some of these sectors are read successfully, the value is decreased. If errors still occur when reading sectors, the hard drive will try to restore the data, transfer it to the reserved disk area (spare area), and mark this sector as remapped. If this attribute value remains at zero, it indicates that the quality of the corresponding surface area is low.
Test Type	Set short or long time to test.
Test Result	Result of the test.
Test Time	Total time of the test.

NOTE

If the Reallocated Sector Count > 32 or Current Pending Sector of a hard disk drive > 0, the status of the disk will show "Warning". This warning is only used to alert the system administrator that there are bad sectors on the disk, and they should replace those disks as soon as possible.

Bad Block Scan

On the **Disks Information** screen, you may also perform disk bad block scan, simply to click "Click to start" to start with. The result is only for reference and system will not take any action from its result.

Disk No.	Capacity (MB)	Model	Firmware	Status	Bad Block Scan
1	1,907,729	WDC WD2002FYPS-0	04.0	OK	▶ Click to start
2	1,907,729	WDC WD2002FYPS-0	04.0	OK	▶ Click to start
3	1,907,729	WDC WD2002FYPS-0	04.0	Warning	▶ Click to start
4	1,907,729	WDC WD2002FYPS-0	04.0	OK	▶ Click to start
5	1,907,729	WDC WD2002FYPS-0	04.0	OK	▶ Click to start
6	1,907,729	WDC WD2002FYPS-0	04.0	OK	▶ Click to start
7	1,907,729	WDC WD2002FYPS-0	04.0	OK	▶ Click to start
8	1,907,729	WDC WD2002FYPS-0	04.0	OK	▶ Click to start

Total Capacity: 15261832 (MB)

The testing result will be stay till system reboot with "Yet to start" displayed as default.

RAID Information

From the **Storage** menu, choose the **RAID** item and the **RAID Information** screen appears.

This screen lists the RAID volumes currently residing on the Thecus IP storage. From this screen, you can get information about the status of your RAID volumes, as well as the capacities allocated for data, and iSCSI. There is also a graph which represents how the RAID volume is currently allocated.

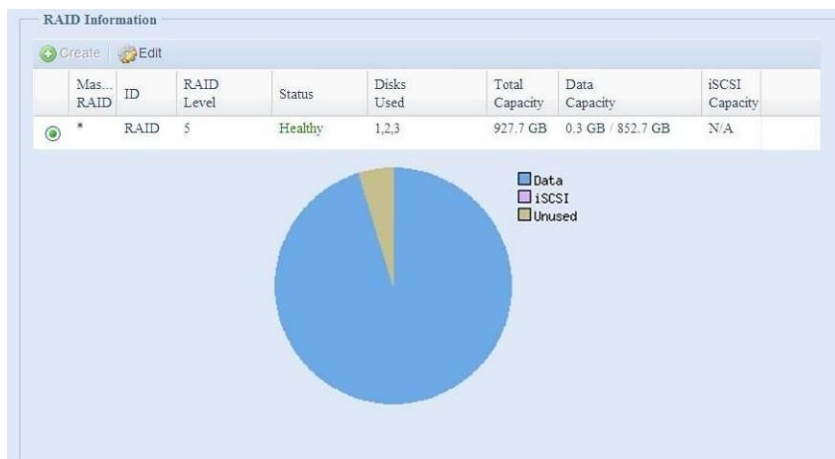

Create a RAID

On the **RAID Information** screen, press the **create** button to go to the **CREATE RAID** screen. In addition to RAID disk information and status, this screen lets you make RAID configuration settings.

Using **Create RAID**, you can select stripe size, choose which disks are RAID disks or the Spare Disk. .

RAID Configurations	
Item	Description
Disk No.	Number assigned to the installed hard disks.
Capacity (MB)	Capacity of the installed hard disks.
Model	Model number of the installed hard disks.
Status	Status of the installed hard disks.
Used	If this is checked, current hard disk is a part of a RAID volume.
Spare	If this is checked, current hard disk is designated as a spare for a RAID volume.
Master RAID	Check a box to designate this as the Master RAID volume. See the NOTE below for more information.
Stripe Size	This sets the stripe size to maximize performance of sequential files in a storage volume. Keep the 64K setting unless you require a special file storage layout in the storage volume. A larger stripe size is better for large files.
Data Percentage	The percentage of the RAID volume that will be used to store data.
Create	Press this button to configure a file system and create the RAID storage volume.

To create a RAID volume, follow the steps below:

1. On the **RAID Information** screen, click **create**.
2. On the **RAID Configuration** screen, set the RAID storage space as **JBOD**, **RAID 0**, **RAID 1**, **RAID 5**, **RAID 6**, or **RAID 10**— see [Appendix B: RAID Basics](#) for a detailed description of each.
3. Specify a RAID ID.
4. If this RAID volume is meant to be the Master RAID volume, tick the **Master RAID** checkbox.

NOTE

In a multiple RAID configuration, one RAID volume must be designated as the Master RAID volume. The Master RAID volume will store all installed modules. If the Master RAID is changed to another location (i.e. assigning volume 2 to be the Master RAID volume after volume 1 had been previously assigned), then all modules must be reinstalled. In addition, all system folders that were contained on the Master RAID volume will be invisible. Reassigning this volume to be the Master RAID will make these folders visible again.

5. Selected whether the RAID volume will be encrypted or not. The RAID volume can protect data by using RAID Volume Encryption function to prevent the risk of data exposure. To activate this function, the **Encryption** option needs to be enabled while the RAID is created and followed by password input for identification. Also, an external writable USB disk plugged into any USB port on the system is required to save the password you have entered while the RAID volume is being created. See the screenshot below for details.

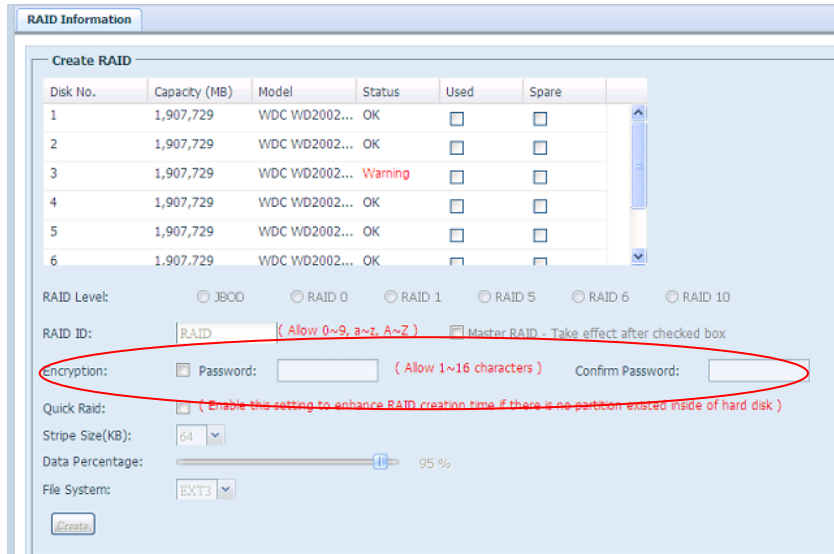

Once the **Create** button has been pressed with the **Encryption** checkbox enabled, the following message pop-up will appear for confirmation.

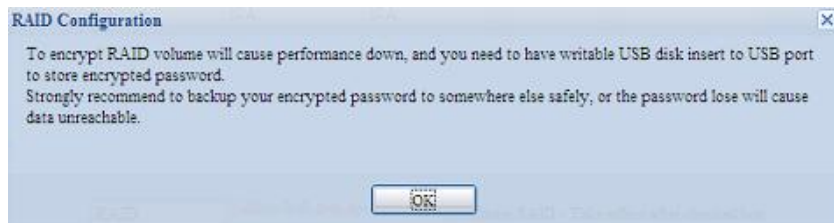

After the RAID volume has been created, you may remove this USB disk until the next time the system boots. The RAID volume can not be mounted if the USB disk with key can not be found in any system USB port when the volume is accessed. To activate the encrypted volume, plug the USB disk containing the encryption key and into any system USB port.

We are strongly recommended copying the RAID volume encryption key to a safe place. You can find the encryption key file from the USB disk in the following format:

`(RAID volume created date)_xxxxxx.key`

WARNING

Please keep USB disk in a safe place and also backup the encrypted key.
There is no way to rescue data back if the key is lost.

NOTE

1. With RAID volume encryption enabled, the system performance will go down.
2. With RAID volume encryption enabled, RAID volume expansion will operated in off line mode.

RAID volumes with encryption enabled will be displayed with a key lock symbol next to volume ID name.

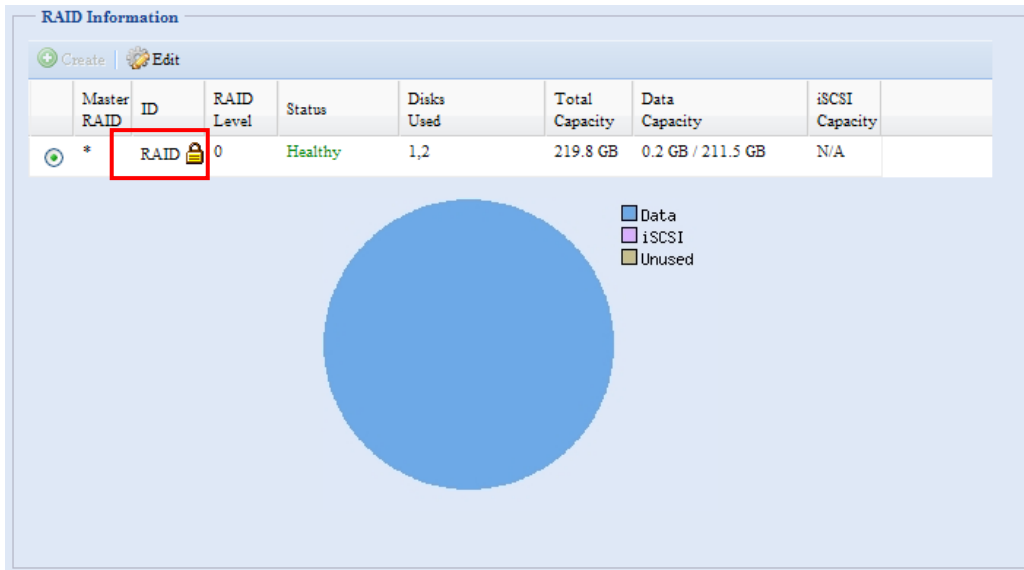

- Specify a stripe size — 64K is the default setting.
- Specify the percentage allocated for user data by drag the horizontal bar. The remaining space will be made available for iSCSI.
- Selected the file system you like to have for this RAID volume. The selection is available from ext3, XFS and ZFS.

NOTE

- Select ZFS file system while snapshot is needed. It is only one ZFS file system allowed to be created per system.
- ZFS file system is only accessible by CIFS/SMB, not for AFP and NFS users.
- XFS file system is not support folder quota feature

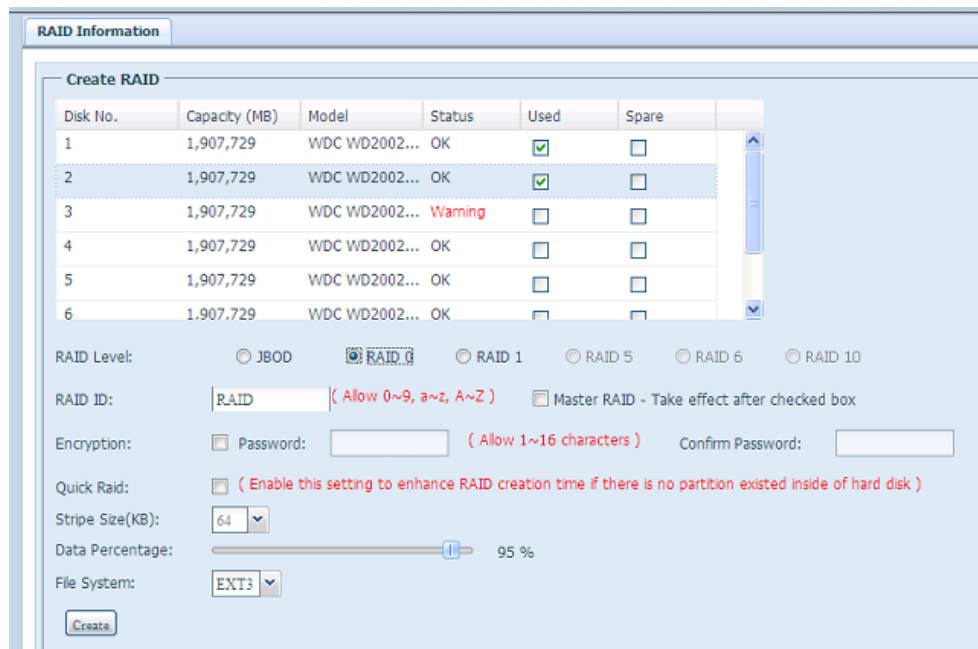

- Press **Create** to build the RAID storage volume.

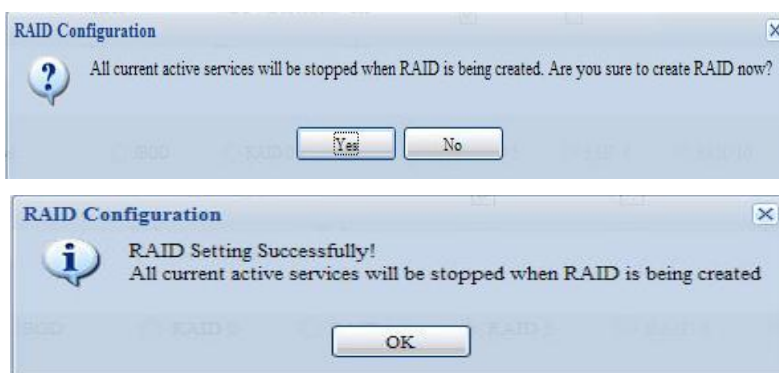
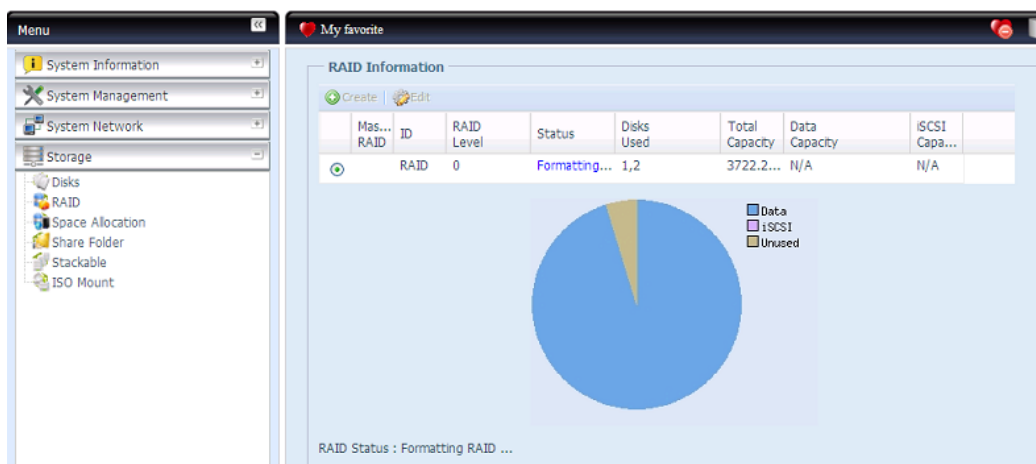

NOTE

Building a RAID volume may take time, depending on the size of hard drives and RAID mode. In general, while the RAID volume building process is up to "RAID Building" then the data volume is capable to be accessed.

WARNING

Creating RAID destroys all data in the current RAID volume. The data is unrecoverable.

With a RAID 1, RAID 5, or RAID 6 volume, you can also add a spare disk after the RAID is created.

See **Chapter 6: Tips and Tricks > Adding a Spare Disk** for details.

For more information on RAID, see **Appendix B: RAID Basics**.

RAID Level

You can set the storage volume as **JBOD, RAID 0, RAID 1, RAID 5, RAID 6 or RAID 10**. RAID configuration is usually required only when you first set up the device. A brief description of each RAID setting follows:

RAID Levels	
Level	Description
JBOD	The storage volume is a single HDD with no RAID support. JBOD requires a minimum of 1 disk.
RAID 0	Provides data striping but no redundancy. Improves performance but not data safety. RAID 0 requires a minimum of 2 disks.
RAID 1	Offers disk mirroring. Provides twice the read rate of single disks, but same write rate. RAID 1 requires a minimum of 2 disks.
RAID 5	Data striping and stripe error correction information provided.

	RAID 5 requires a minimum of 3 disks. RAID 5 can sustain one failed disk.
RAID 6	Two independent parity computations must be used in order to provide protection against double disk failure. Two different algorithms are employed to achieve this purpose. RAID 6 requires a minimum of 4 disks. RAID 6 can sustain two failed disks.
RAID 10	RAID 10 has high reliability and high performance. RAID 10 is implemented as a striped array whose segments are RAID 1 arrays. It has the fault tolerance of RAID 1 and the performance of RAID 0. RAID 10 requires 4 disks. RAID 10 can sustain two failed disks.

WARNING

If the administrator improperly removes a hard disk that should not be removed when RAID status is degraded, all data will be lost.

Edit RAID

On the **RAID Information** screen, press the **Edit** button to go to the **RAID Information** screen.

Using **Edit RAID**, you can select RAID ID and the Spare Disk. .

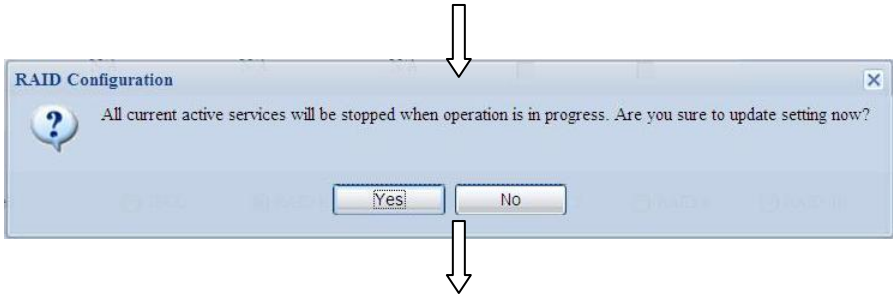
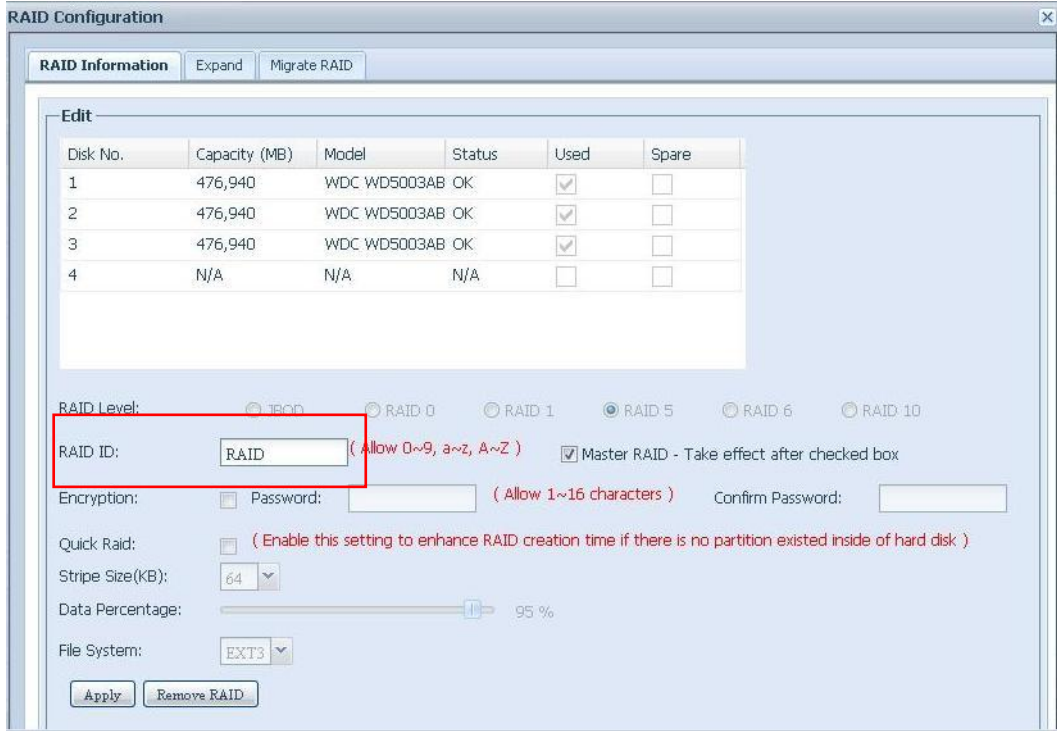



Remove RAID

Click to remove the RAID volume. All user data and iSCSI has been created in selected RAID volume will be removed.

To remove a RAID volume, follow the steps below:

1. On the RAID List screen, select the RAID volume by clicking on its radio button, and click **RAID Information** to open the **RAID Configuration** screen.
2. On the **RAID Configuration** screen, click **Remove RAID**.
3. The confirmation screen appear, you will have to input "Yes" with exactly wording case to complete "**Remove RAID**" operation

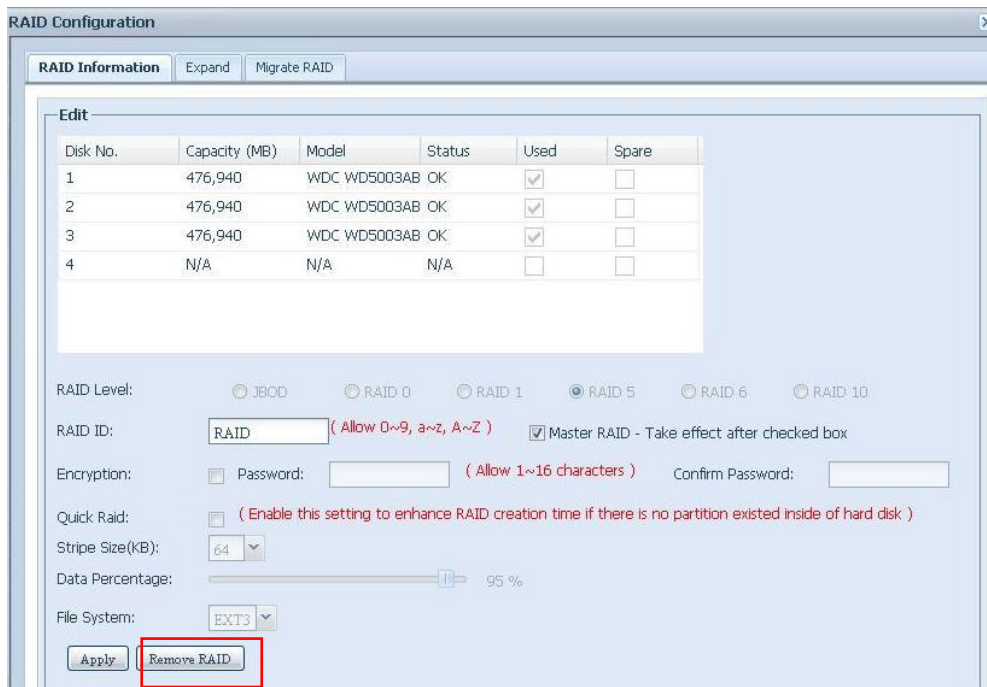

WARNING

Remove RAID destroys all data in the current RAID volume. The data is unrecoverable.

Expanding a RAID

To expand a RAID 1, RAID 5, or RAID 6 volume, follow the steps below:

1. Replace one of the hard drives in the RAID volume and allow it to automatically rebuild.

2. Once rebuilt, you can continue to replace any remaining disks in the RAID array.
3. When you are done replacing hard drives, log on to Web Management. Navigate to **Storage > RAID** to open the **RAID Configuration** screen.
4. On the **RAID Information** screen, and click **Edit** to open the **RAID Configuration** screen.
5. On the **RAID Configuration** screen, click **Expand**.

NOTE

RAID expansion did not support file system created by ZFS.

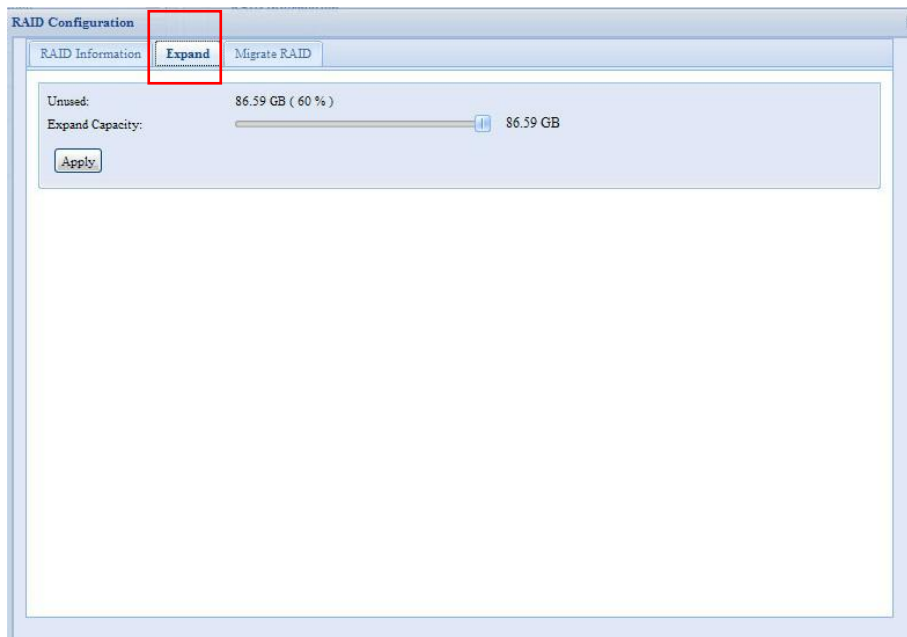

Migrating a RAID

Once a RAID volume has been created, you may want to move it to other physical drives or change the RAID array all together. To migrate a RAID 0, RAID 1, RAID 5 or RAID 6 volume, follow the steps below:

1. From the RAID Configuration screen, click **Migrate RAID**.
2. A list of possible RAID migration configurations will be listed. Select the desired migration scheme and click **Apply**.
3. The system will begin migrating the RAID volume.

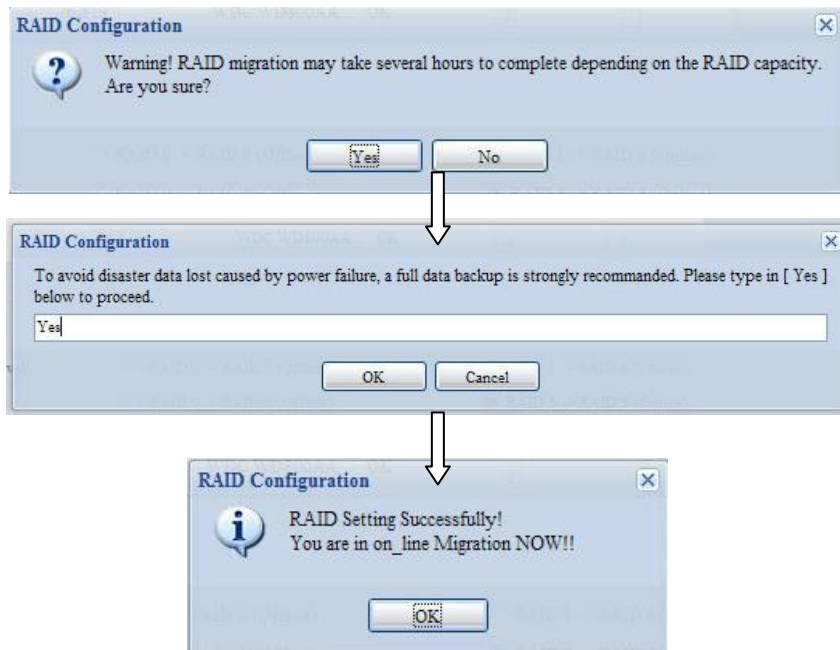
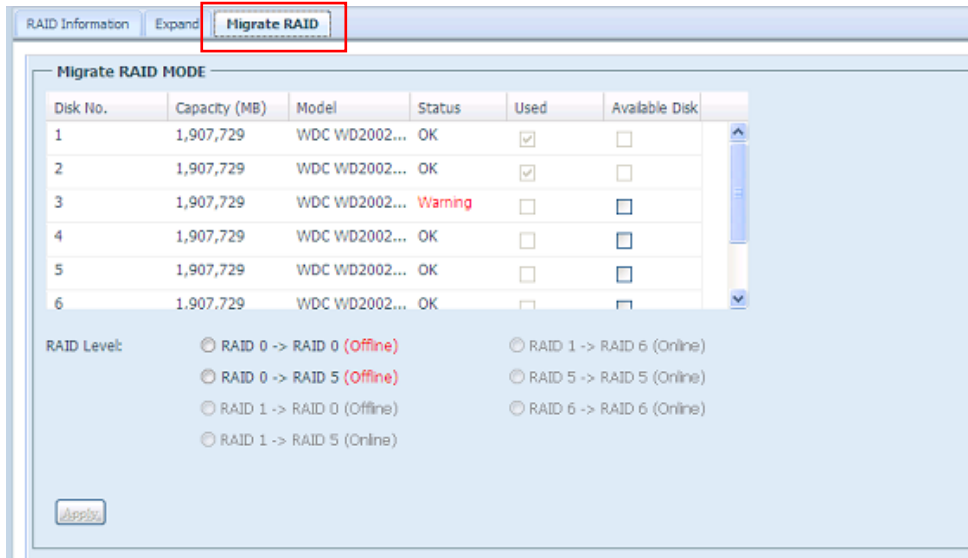

NOTE Migrating a RAID volume could take several hours to complete

With RAID level migration function, the limitation as listed below.

1. During RAID level migration, it is not allowed reboot or shutdown system.
2. The RAID migration from **R1 to R5 or R1 to R6**, the all services will restart and volumes "iSCSI" is read only but "user data" is capable read / write during operation.

NOTE The migration scheme below is based on Thecus IP Storage series products in maximum possible combination. The other model which has less HDD supported can refer web UI while RAID migration operated.

Below is a table listing of possible RAID migration schemes:

To From	RAID 0	RAID 5	RAID 6
RAID 1		[RAID 1] HDDx2 to [RAID 5] HDDx3 [RAID 1] HDDx2 to [RAID 5] HDDx4 [RAID 1] HDDx2 to [RAID 5] HDDx5 [RAID 1] HDDx2 to [RAID 5] HDDx6 [RAID 1] HDDx2 to [RAID 5] HDDx7 [RAID 1] HDDx2 to [RAID 5] HDDx8HDDx16 [RAID 1] HDDx3 to [RAID 5] HDDx4 [RAID 1] HDDx3 to [RAID 5] HDDx5 [RAID 1] HDDx3 to [RAID 5] HDDx6 [RAID 1] HDDx3 to [RAID 5] HDDx7 [RAID 1] HDDx3 to [RAID 5] HDDx8HDDx16 [RAID 1] HDDx4 to [RAID 5] HDDx5 [RAID 1] HDDx4 to [RAID 5] HDDx6 [RAID 1] HDDx4 to [RAID 5] HDDx7 [RAID 1] HDDx4 to [RAID 5] HDDx8HDDx16 [RAID 1] HDDx5 to [RAID 5] HDDx6 [RAID 1] HDDx5 to [RAID 5] HDDx7 [RAID 1] HDDx5 to [RAID 5] HDDx8HDDx16 [RAID 1] HDDx6 to [RAID 5] HDDx7 [RAID 1] HDDx6 to [RAID 5] HDDx8HDDx16 [RAID 1] HDDx7 to [RAID 5] HDDx8HDDx16	[RAID 1] HDDx2 to [RAID 6] HDDx4 [RAID 1] HDDx2 to [RAID 6] HDDx5 [RAID 1] HDDx2 to [RAID 6] HDDx6 [RAID 1] HDDx2 to [RAID 6] HDDx7 [RAID 1] HDDx2 to [RAID 6] HDDx8HDDx16 [RAID 1] HDDx3 to [RAID 6] HDDx4 [RAID 1] HDDx3 to [RAID 6] HDDx5 [RAID 1] HDDx3 to [RAID 6] HDDx6 [RAID 1] HDDx3 to [RAID 6] HDDx7 [RAID 1] HDDx3 to [RAID 6] HDDx8HDDx16 [RAID 1] HDDx4 to [RAID 6] HDDx5 [RAID 1] HDDx4 to [RAID 6] HDDx6 [RAID 1] HDDx4 to [RAID 6] HDDx7 [RAID 1] HDDx4 to [RAID 6] HDDx8HDDx16 [RAID 1] HDDx5 to [RAID 6] HDDx6 [RAID 1] HDDx5 to [RAID 6] HDDx7 [RAID 1] HDDx5 to [RAID 6] HDDx8HDDx16 [RAID 1] HDDx6 to [RAID 6] HDDx7 [RAID 1] HDDx6 to [RAID 6] HDDx8HDDx16 [RAID 1] HDDx7 to [RAID 6] HDDx8HDDx16
RAID 5	X	[RAID 5] HDDx3 to [RAID 5] HDDx4 [RAID 5] HDDx3 to [RAID 5] HDDx5 [RAID 5] HDDx3 to [RAID 5] HDDx6 [RAID 5] HDDx3 to [RAID 5] HDDx7 [RAID 5] HDDx3 to [RAID 5] HDDx8HDDx16 [RAID 5] HDDx4 to [RAID 5] HDDx5 [RAID 5] HDDx4 to [RAID 5] HDDx6 [RAID 5] HDDx4 to [RAID 5] HDDx7 [RAID 5] HDDx4 to [RAID 5] HDDx8HDDx16 [RAID 5] HDDx5 to [RAID 5] HDDx6 [RAID 5] HDDx5 to [RAID 5] HDDx7 [RAID 5] HDDx5 to [RAID 5] HDDx8HDDx16 [RAID 5] HDDx6 to [RAID 5] HDDx7 [RAID 5] HDDx6 to [RAID 5] HDDx8HDDx16 [RAID 6] HDDx7 to [RAID 6] HDDx8HDDx16	X

RAID 6	X	X	[ONLINE] [RAID 6] HDDx4 to [RAID 6] HDDx5 [RAID 6] HDDx4 to [RAID 6] HDDx6 [RAID 6] HDDx4 to [RAID 6] HDDx7 [RAID 6] HDDx4 to [RAID 6] HDDx8HDDx16 [RAID 6] HDDx5 to [RAID 6] HDDx6 [RAID 6] HDDx5 to [RAID 6] HDDx7 [RAID 6] HDDx5 to [RAID 6] HDDx8HDDx16 [RAID 6] HDDx6 to [RAID 6] HDDx7 [RAID 6] HDDx6 to [RAID 6] HDDx8HDDx16 [RAID 6] HDDx7 to [RAID 6] HDDx8HDDx16
-----------	---	---	--

Space Allocation

iSCSI Target

You may specify the space allocated for iSCSI or target USB volumes (target USB is available in model N5500 and 1U4600). The iSCSI volume can be created from 2 to 25 volumes per system depend on Thecus IP storage's model.

Model	N4100PRO	N0503 N3200XXX	N4200 series N2200XXX N5200XXX 1U4200XXX N8200XXX	N5500 1U4600	N7700 N7700+ N8800 N8800+	N7700PRO N7700SAS N8800PRO N8800SAS
Allow iSCSI volume	2	5	10	10	15	25

To do this, under the **Storage** menu, click **RAID** and the **RAID List** window appears. Select the RAID volume you wish to reallocate by clicking on its radio button, and click **Space Allocation**. The **RAID Information** and **Volume Allocation List** windows will appear.

The Volume Allocation List displays the space allocated for **iSCSI** volumes on the current RAID volume.

Space Allocation

RAID Information

Master RAID	ID	RAID Level	Status	Disks Used	Total Capacity	Data Capacity	iSCSI Capacity
*	RAID	5	Healthy	1,2,3	927.7	0.3 GB / 852.7 GB	N/A

Volume Allocation List

iSCSI Target | iSCSI Thin-Provision Target | Advance Option

[Add](#) | [Modify](#) | [Expand](#) | [Delete](#)

Type	Name	Capacity
------	------	----------

Volume Allocation List	
Item	Description
Modify	Click this to modify the allocated space.
Delete	Click this to delete the allocated space.
iSCSI Target	Click to allocate space to iSCSI volume.
Type	Type of volume. Can be either USB or iSCSI.
Name	Name assigned to the volume.
Capacity	Capacity of the allocated space.

Allocating Space for iSCSI Volume

Space Allocation

RAID Information

Master RAID	ID	RAID Level	Status	Disks Used	Total Capacity	Data Capacity	iSCSI Capacity
*	RAID	5	Healthy	1,2,3	927.7	0.6 GB / 852.7 GB	46.4 GB

Volume Allocation List

iSCSI Target | iSCSI Thin-Provision Target | Advance Option

[Add](#) | [Modify](#) | [Expand](#) | [Delete](#)

Type	Name	Capacity
iSCSI	iscsi10	46.4 GB

To allocate space for an iSCSI volume on the current RAID volume, follow the steps below:

1. Under the **Volume Allocation List**, select **iSCSI Target** then click **Add**. The **Create iSCSI Volume** screen appears.

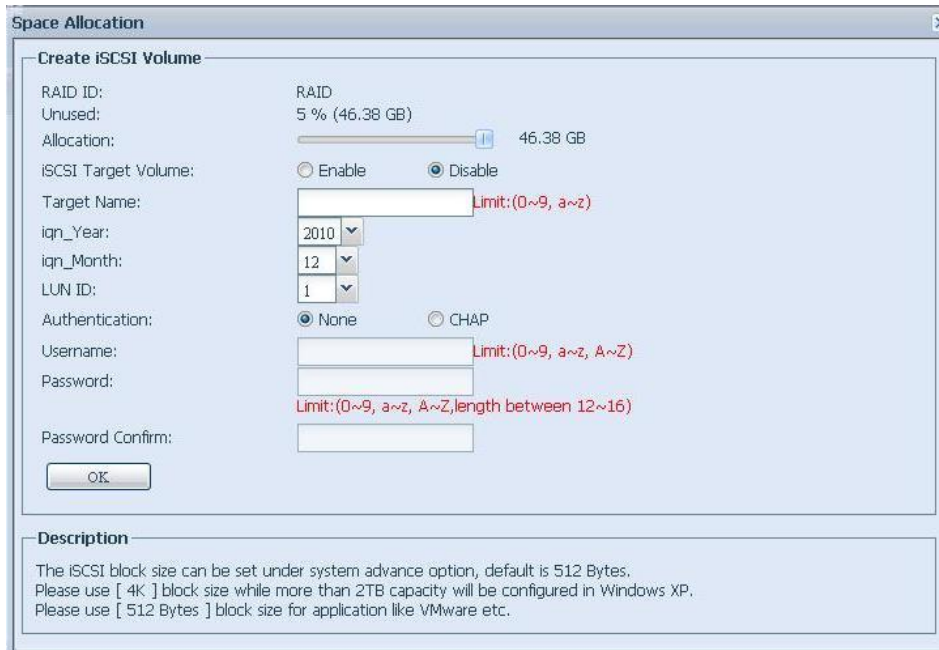

Create iSCSI Volume	
Item	Description
RAID ID	ID of current RAID volume.
Allocation	Percentage and amount of space allocated to iSCSI volume.
Unused	Percentage and amount of unused space on current RAID volume.
iSCSI Target Volume	Enable or Disable the iSCSI Target Volume.
Target Name	Name of the iSCSI Target. This name will be used by the Stackable NAS function to identify this export share.
Year	Select the current year from the dropdown.
Authentication	You may choose CHAP authentication or choose None.
Month	Select the current month from the dropdown.
LUN ID	Specific Logic unit ID number.
Username	Enter a username.
Password	Enter a password.
Password Confirm	Reenter the chosen password

2. Designate the percentage to be allocated from the **Allocation** drag bar.
3. Enable the **iSCSI Target Service** by selecting **Enable**.
4. Choose to enable **CHAP** authentication or choose **None**.
5. Enter a **Target Name**. This will be used by the **Stackable NAS** function to identify this export share.
6. Choose the current year from the **Year** dropdown.
7. Choose the current month from the **Month** dropdown.

8. When iSCSI target volume has been created, the LUN ID is configurable from 1 to 254 with a default of the next available number in ascending numerical order. The LUN ID is unique and can not be duplicated except for LUN ID 0.
9. If you've enabled CHAP authentication, enter a **username** and a **password**. Confirm your chosen password by reentering it in the **Password Confirm** box.
10. Click **OK** to create the iSCSI volume.

Modify iSCSI Volume

To Modify iSCSI volume on the current RAID volume, follow the steps below:

1. Under the **Volume Allocation List**, click **Modify**.
The **Modify iSCSI Volume** screen appears.

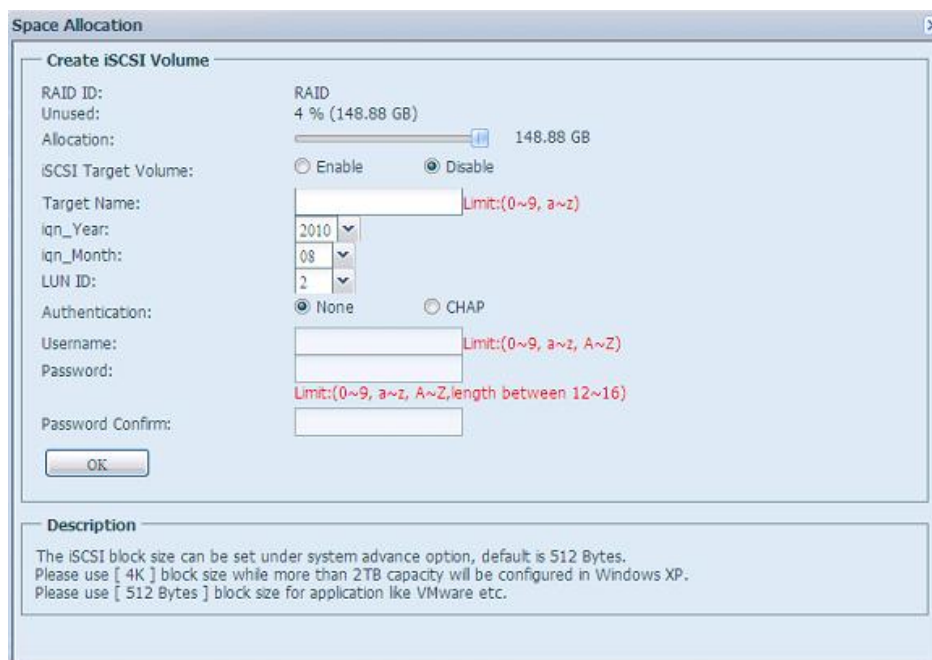
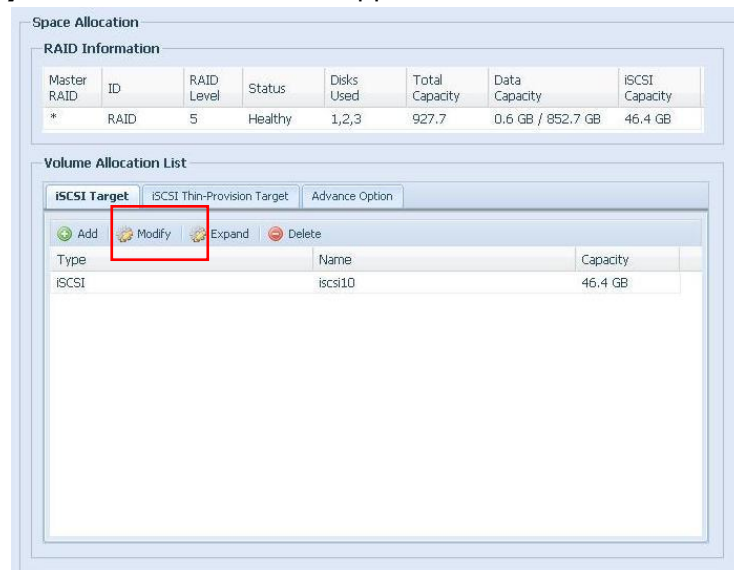

2. Modify your setting. Press **ok** to change.

Expand Volume

The iSCSI volume is now able to expand its capacity from unused space. From the volume list, simply select the iSCSI volume you like to expand and click the **Expand** button:

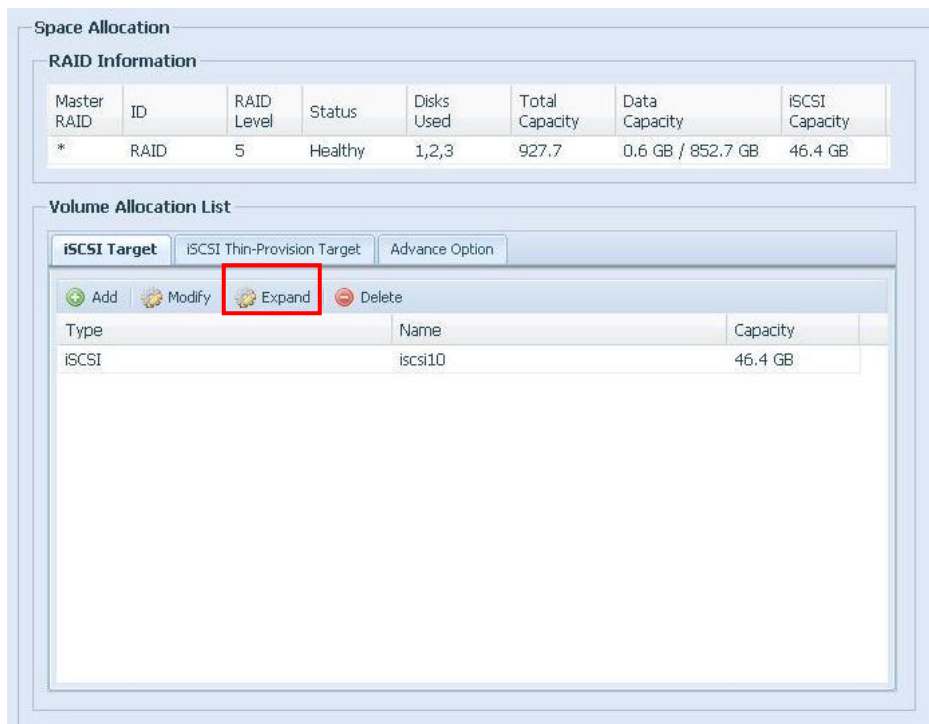

You will then see the dialog box displayed below. Drag the **Expand Capacity** bar to the size you want. Then press **Expand** to confirm the operation.

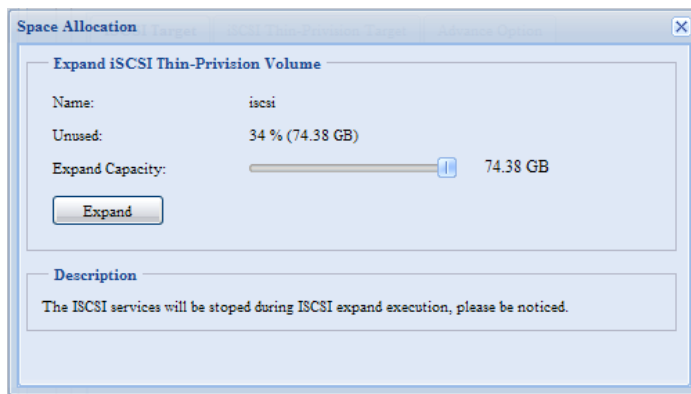

Delete Volume

To delete volume on the current RAID volume, follow the steps below:

1. Under the **Volume Allocation List**, click **Delete**.
The **Space Allocation** screen appears.

Space Allocation

RAID Information

Master RAID	ID	RAID Level	Status	Disks Used	Total Capacity	Data Capacity	iSCSI Capacity
*	RAID	5	Healthy	1,2,3	927.7	0.6 GB / 852.7 GB	46.4 GB

Volume Allocation List

iSCSI Target | iSCSI Thin-Provision Target | Advance Option

Type	Name	Capacity
iSCSI	iscsi10	46.4 GB

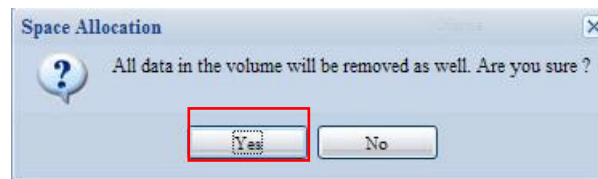

2. Press **YES**. All data in the volume will be removed.

iSCSI Thin-Provisioning

With this function, the iSCSI capacity can be more flexible and more efficiently serve more users.

The idea for iSCSI thin-provisioning is sharing the available physical capacity to a number of iSCSI target volumes and also setup virtual capacity to expand the physical size while it needed.

To setup iSCSI thin-provisioning, go to **Space Allocation** under the **Storage** category. The iSCSI thin-provisioning volume needs to be created first. Simply click **iSCSI Thin-Provision Target**. You can refer the screen shot below.

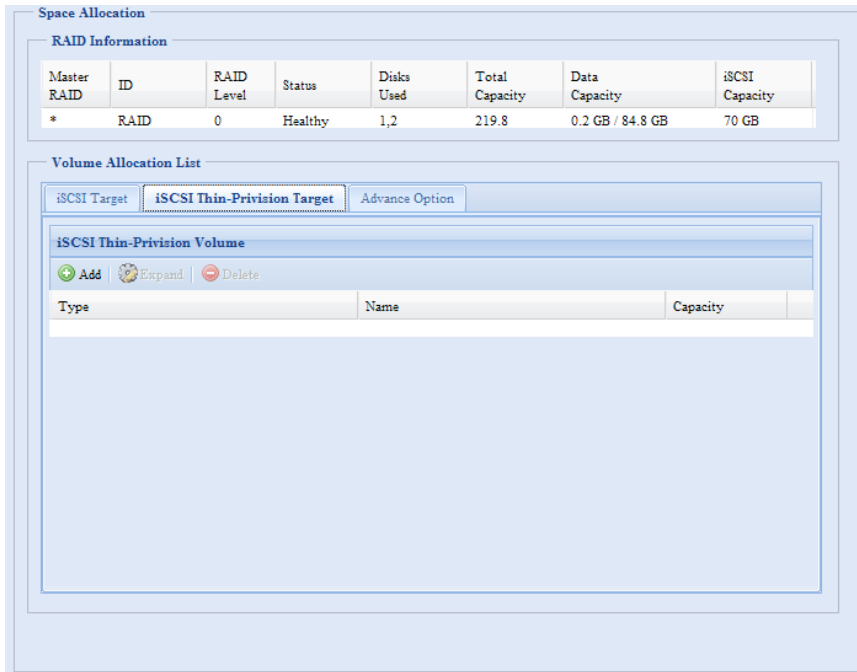

Next, setup the physical capacity for iSCSI thin-provision volume by dragging the **Allocation** bar to the desired size.

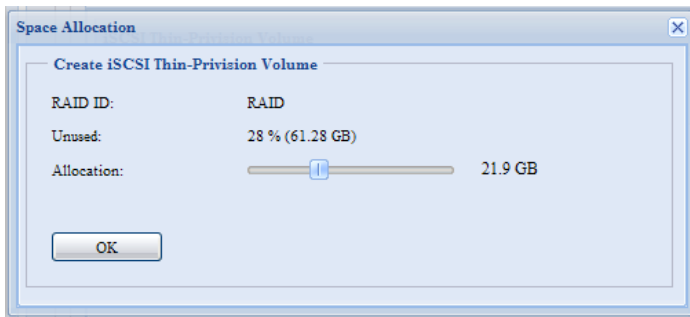

After the size has been determined, click **OK** to confirm. Now you will see the iSCSI thin-provisioning volume is available from the list. Please refer to the screenshot below.

Space Allocation

RAID Information

Master RAID	ID	RAID Level	Status	Disks Used	Total Capacity	Data Capacity	iSCSI Capacity
*	RAID	0	Healthy	1,2	219.8	0.2 GB / 84.8 GB	91.9 GB

Volume Allocation List

iSCSI Target iSCSI Thin-Prvision Target Advance Option

iSCSI Thin-Prvision Volume

Add Expand Delete

Type	Name	Capacity
iSCSI Thin-Prvision Volume	iSCSI Thin-Prvision Volume	21.9 GB

iSCSI Thin-Prvision

Add Modify Delete

Type	Name	Capacity
------	------	----------

Now you can start to create iSCSI targets to join the newly-created iSCSI thin-provision volume. Basically, the iSCSI target under iSCSI thin-provisioning has exactly same settings screen as the standard iSCSI target volume creation. The only difference is the "Virtual Size" of capacity.

Unlike creating standard iSCSI target volumes, the capacity has been physically allocated. The iSCSI target volume creation under thin-provisioning can virtually be up to 16000GB (16TB).

Let's take the example below:

1. The physical size for the iSCSI thin-provision volume is 333.88GB. You can refer the screenshot above.
2. The iSCSI target volume under thin-provisioning starts with 333.38GB in physical size and you may use drag the Virtual Size bar to select the desired virtual size. The maximum virtual size is 16000GB.
3. In this case, if you make the iSCSI target volume 1700GB, then the virtual size is available for the next iSCSI target volume under thin-provisioning is 14300GB (16000-1700).
4. The limit is 5 iSCSI target volumes under thin-provisioning or a virtual size of 16000GB.

RAID ID: RAID

Unused: 18 % (333.88 GB)

Virtual Size: 333.8 GB

iSCSI Thin-provision physical size starts with 333.8GB

Unused: 18 % (333.88 GB)

Virtual Size: 16000 GB

iSCSI Target Volume: Enable Disable

The virtual capacity is limited to 16000GB

The screen shot for iSCSI target volume creation under thin-provisioning; the physical capacity 333.8GB.

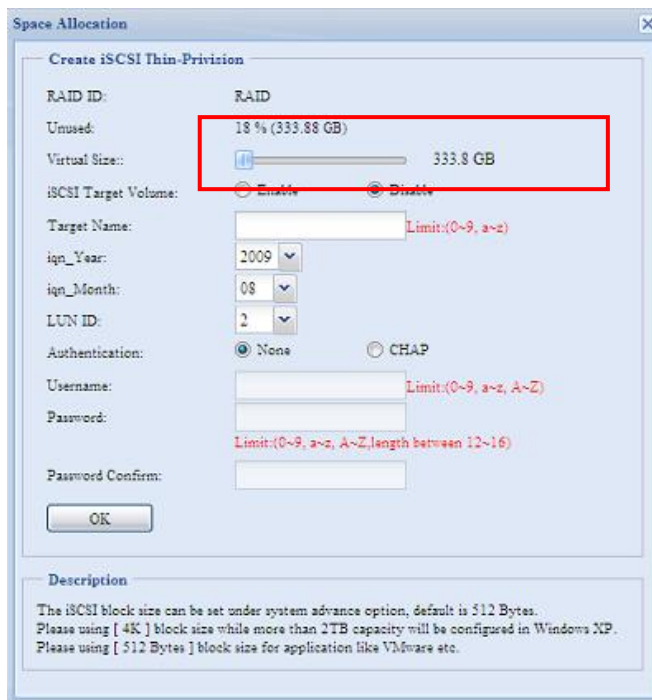

The screen shot to setup an iSCSI target volume under thin-provisioning of 1700GB.

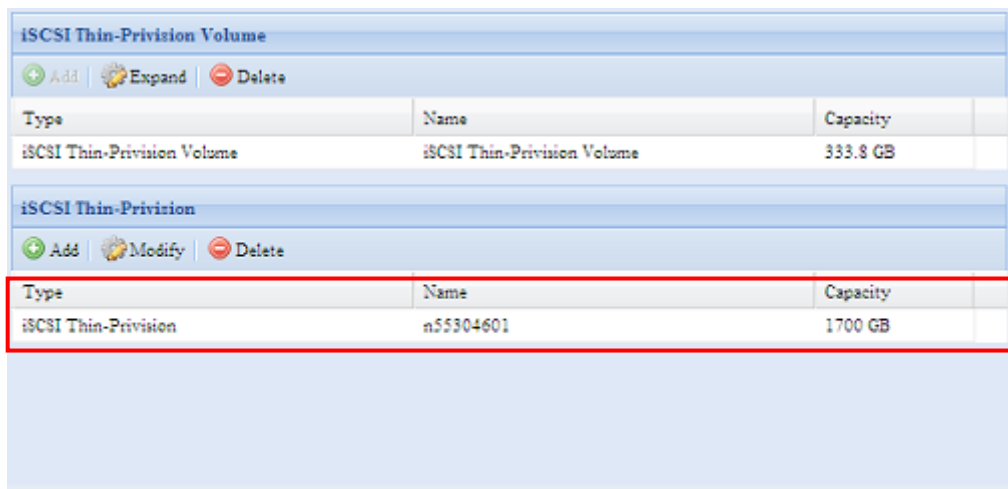

iSCSI target volume creation. The maximum virtual size is 14300GB (16000GB – 1700GB(1st iSCSI target volume)).

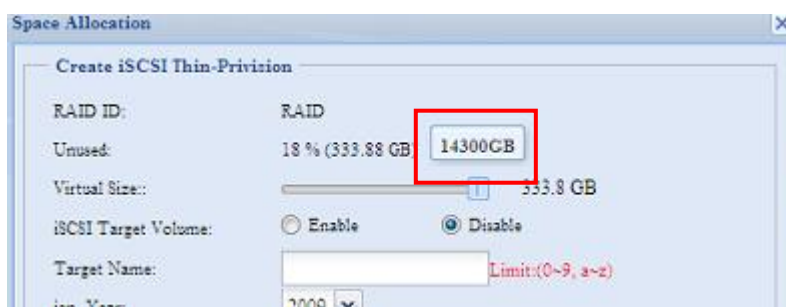

This screenshot lists iSCSI target volumes created under thin-provisioning. The 2nd iSCSI target volume under thin-provisioning has been created with a capacity of 14300GB.

iSCSI Thin-Provision Volume		
Add Expand Delete		
Type	Name	Capacity
iSCSI Thin-Provision Volume	iSCSI Thin-Provision Volume	333.8 GB

iSCSI Thin-Provision		
Add Modify Delete		
Type	Name	Capacity
iSCSI Thin-Provision	n55304601	1700 GB
iSCSI Thin-Provision	n554036002	14300 GB

This message appears if there is no more room for new iSCSI target creation.

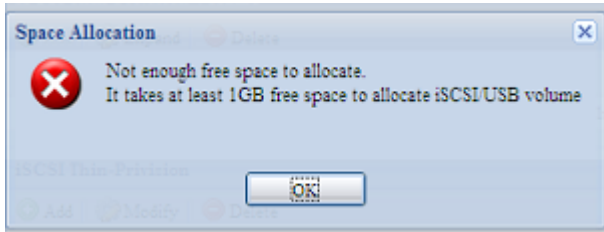

NOTE

1. Each RAID volume can only create one iSCSI thin-provision volume.
2. Each thin-provision volume can only create 5 iSCSI target volumes.
3. The notification will send out while the physical size of iSCSI thin-provision capacity has used up to 90%.

Advance Option

There are 2 options is currently allow Admin to Enable/Disable to operate Thecus IP storage associated with iSCSI setting. The details as listed in following screenshot. With the option changed, it will need to reboot system to activate.

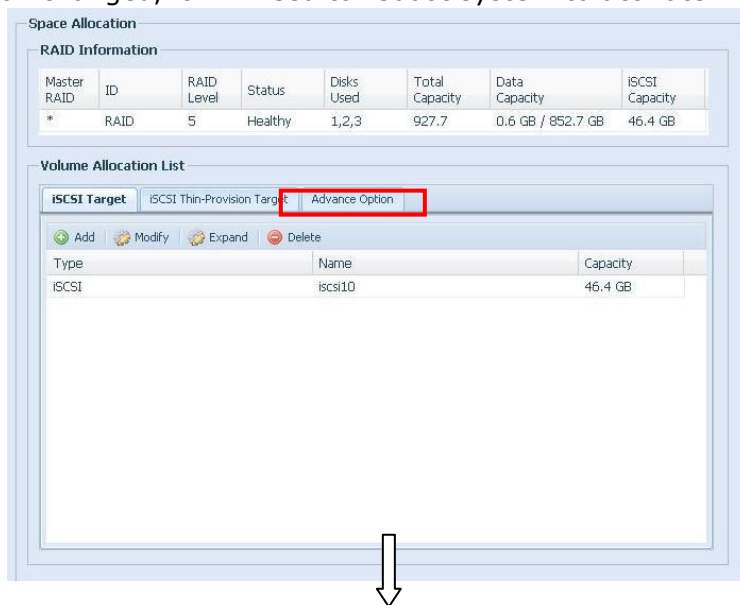

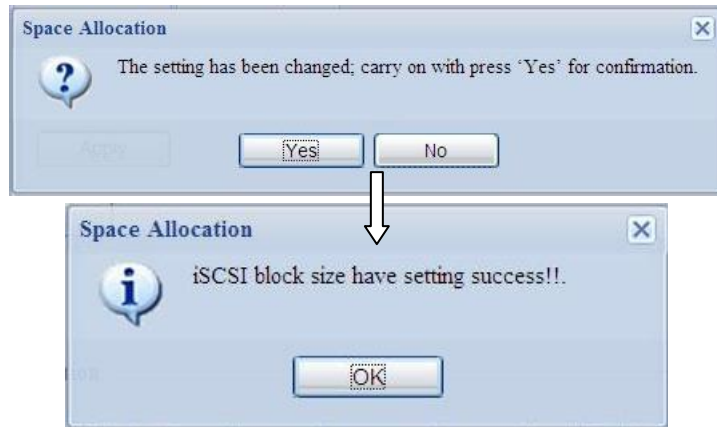

iSCSI Block Size

Select the block size with 4K while the iSCSI volume size is over 2TB.

iSCSI CRC/Checksum

To enable this option, the initiator can connect with "Data digest" and "Header digest" enabled.



Stackable NAS

The Thecus IP storage's capacity can be expanded even further using the stackable function. With it, users can expand the capacity of their network storage systems up to 5 other stack target volumes which are located in different systems. These can be stacked through single network access like SMB or AFP acting as a share folder type.

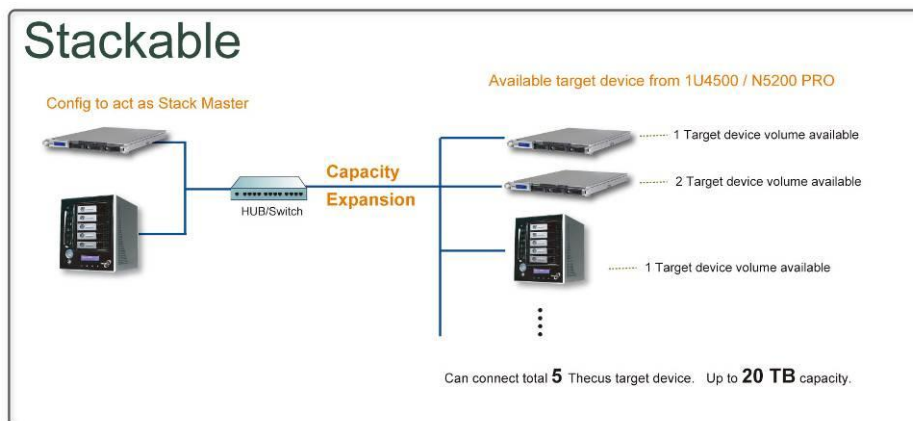

From the main menu, the stackable feature is located under "Storage". Please refer the figure below for reference.

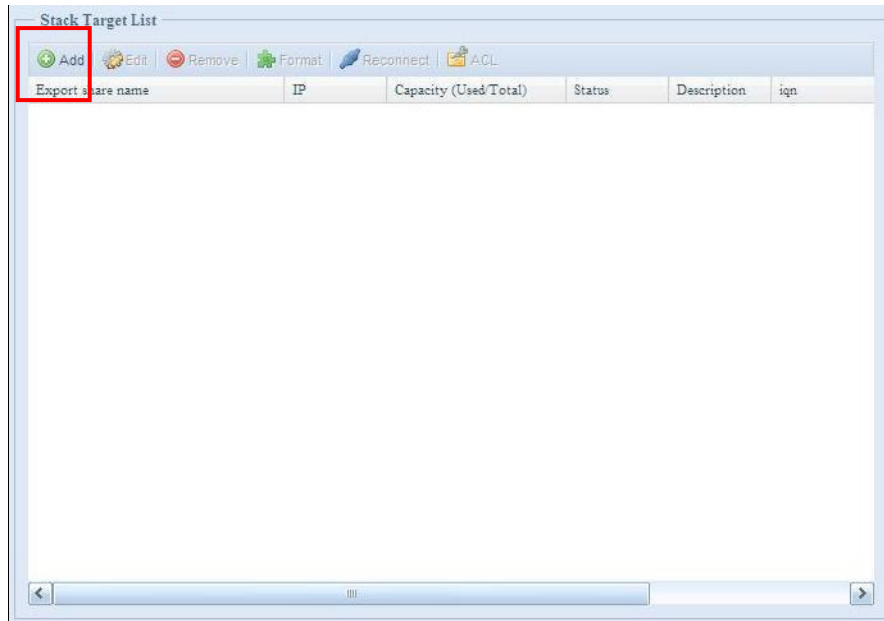

A. Add a Stack Target Volume

From the figure above, click **Add** to access the stackable target device configuration page. Please refer to the figure below:

With the added stack target you could "Enable" or "Disable" now or later per usage needed.

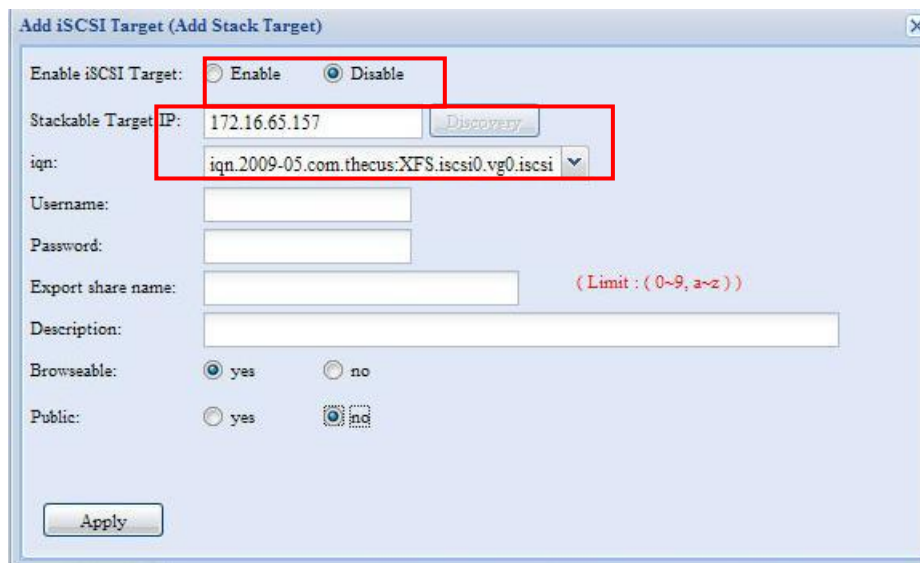

Next, input the target IP address of the stackable device and click the **Discovery** button. The system will list available target volumes from the inputted IP address.

Once IP with volume have been set, you may need to input a valid user name and password to validate your access rights. If there is no user name and password needed to access target volume, then leave it blank.

Add iSCSI Target (Add Stack Target)

Enable iSCSI Target: Enable Disable

Stackable Target IP: 172.16.65.157

iqn: iqn.2009-05.com.thecus.XFS.iscsi0.vg0.iscsi

Username:

Password:

Export share name: (Limit : (0~9, a~z))

Description:

Browseable: yes no

Public: yes no

The **Export share name** will become the network share name and displayed through network access such as SMB. You may refer the figures below to see the result. Please note the naming limitation.

Add iSCSI Target (Add Stack Target)

Enable iSCSI Target: Enable Disable

Stackable Target IP: 172.16.66.39

iqn: iqn.2009-6.com.thecus.aaaa.iscsi0.vg0.abcd

Username:

Password:

Export share name: pnmeeting (Limit : (0~9, a~z))

Description:

Browseable: yes no

Public: yes no

From the figure above, the **Export share name** is "pmmeeting". The figures below show the result before and after via Microsoft Network Access with settings have been completed.

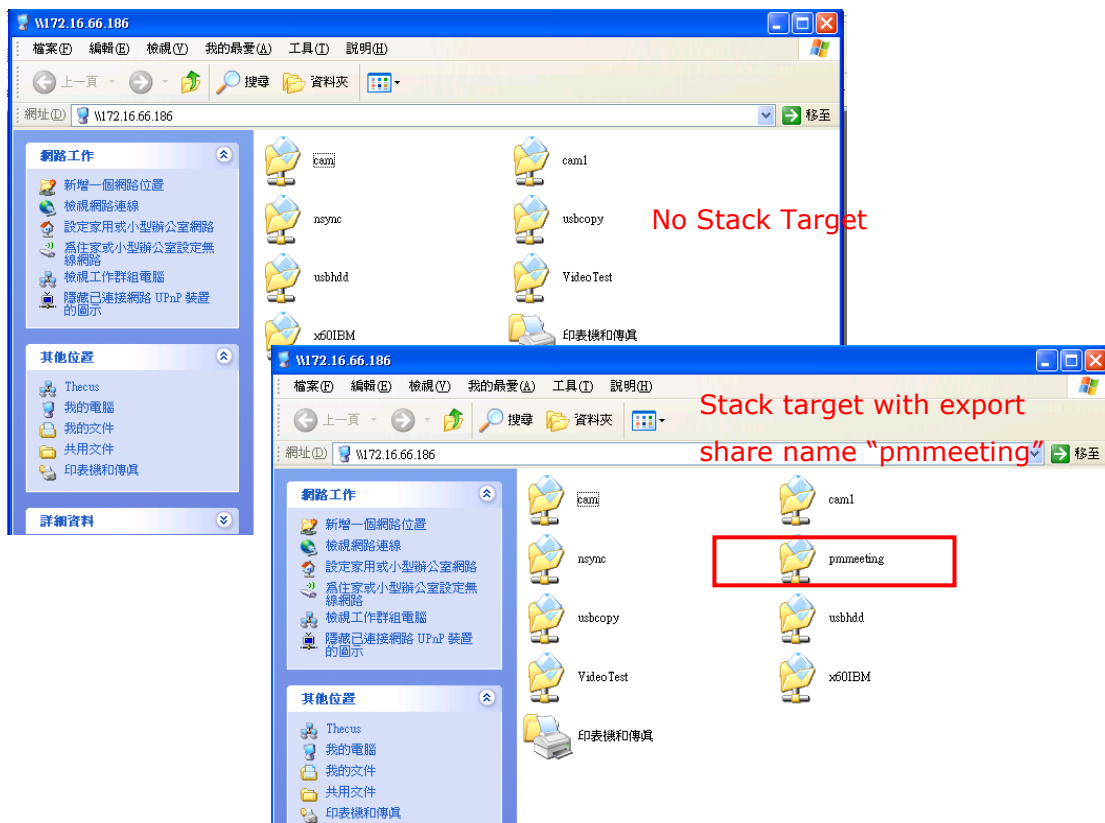

The **Browseable** setting will be same method of setting for system share folder. It designates whether or not this folder will be visible through web disk. You may refer the figures below for reference when **Yes** and **No** are selected.

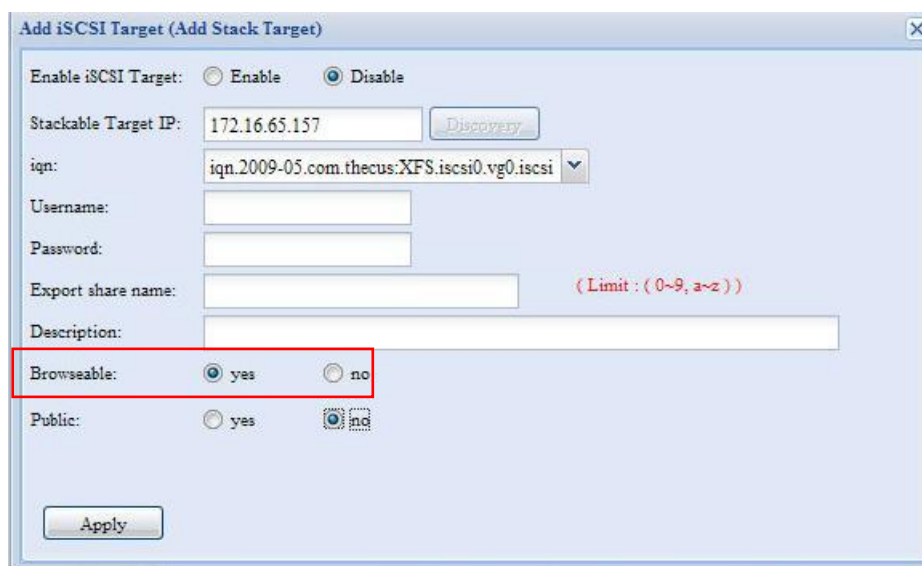

The **Public** setting will be set same as what the setting for the system share folder associated with the ACL permission setup. If **Public** is set to **Yes**, all users will be

able to access it, and **ACL** button will be grayed out. If **Public** is set to **No**, the ACL button will be available on the **Stack Target List** window.

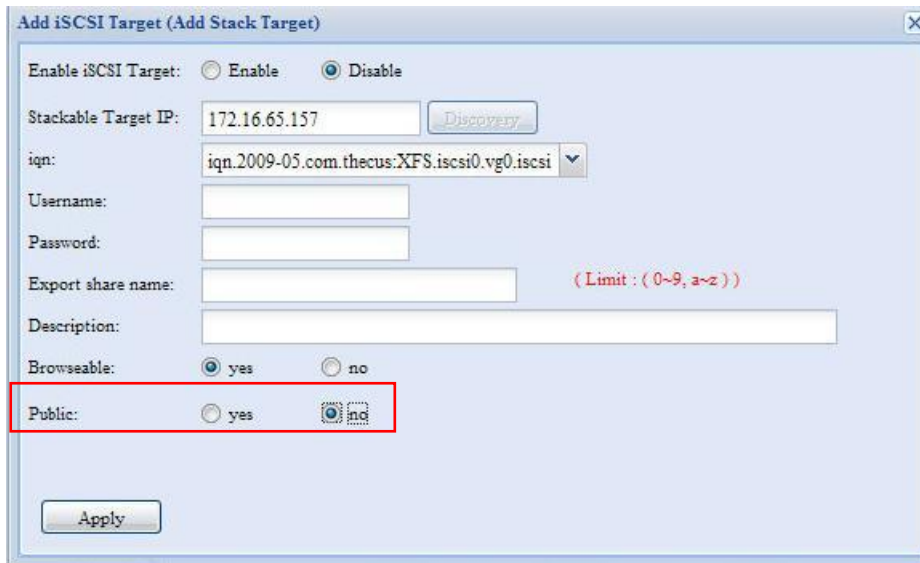

Click **Apply** to save your changes.

B. Activate a Stack Target

After your settings have been applied, the system will bring you back to **Stack Target List** window as shown below. There is one stack target device has been attached into this stack master.

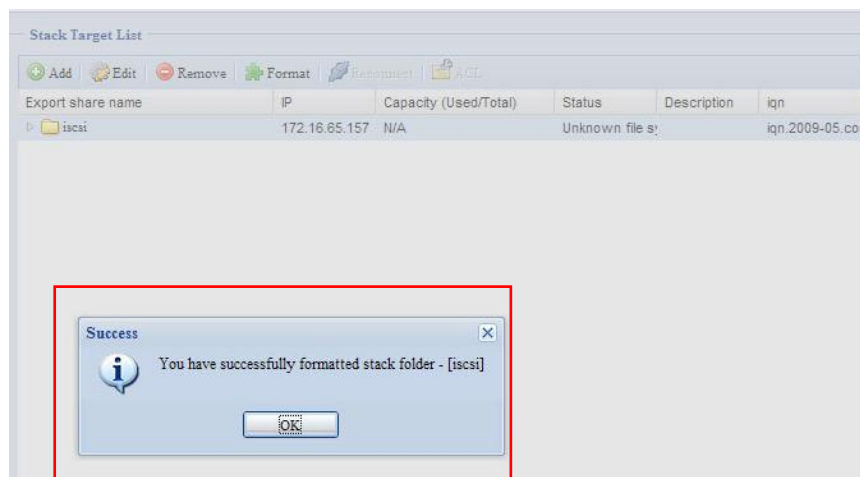
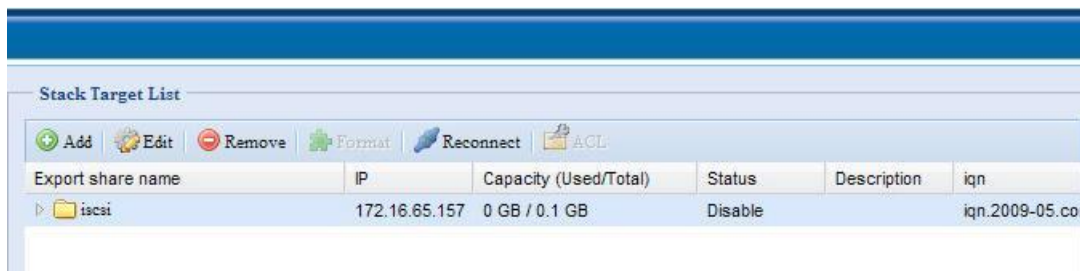

With this newly attached stack target device, you will see the information displayed and also several options you can choose.

In general, if attached stack target device has been used by another Thecus IP storage as stack target volume, then the **Format** item will be display and system will recognize it straight away and display its capacity. Otherwise, the **Format** item will be available and the **Capacity** and **Status** items will show as "N/A" and "Unknown file system" respectively.

Next, click **Format** to proceed with formatting.
 After the format is complete, the stack target volume will be created successfully.
 You will see the volume's capacity and status in the **Stack Target List** screen.

C. Edit a Stack Target

To make any changes to stack targets, click **Edit** for the corresponding stack target, and system will bring up the following dialogue:

After your changes have been made, click **Apply** to confirm any modifications. Once changes are applied, the associated information will be updated on the **Stack Target List** window.

D. Stack Target ACL

If the stack target **Public** setting set to **Yes**, then the **ACL** button will be grayed out. However, if **Public** setting is set to **No**, then the **ACL** button will be available for you to setup user access permissions for the stack target.

ACL settings will be exactly the same as system folder that you may have setup previously.

E. Reconnect a Stack Target

The enabled stack target devices may be disconnected by situations such as power outages or network disconnects. When this happens, the **Reconnect** button will be available. To attempt to reconnect the stack target, click **Reconnect**.

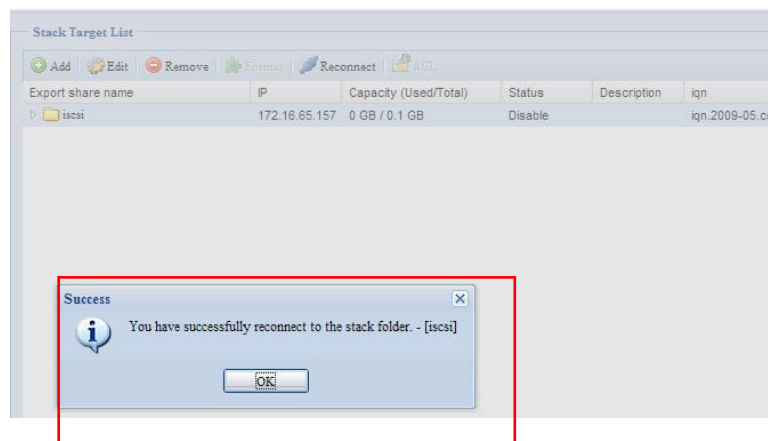
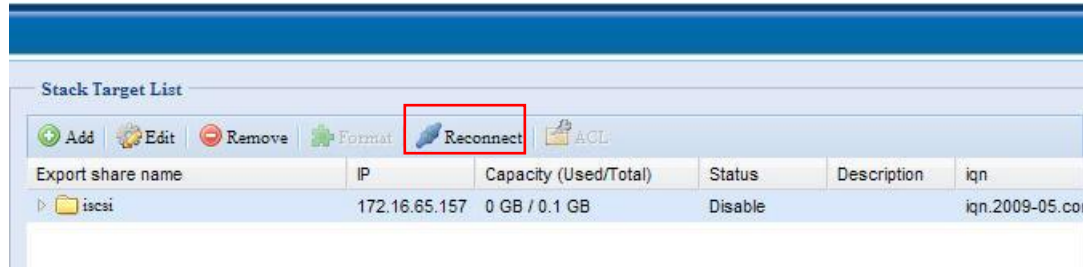

ISO Mount

The ISO Mount feature is very useful tool from Thecus products. With it, users can mount an ISO file and having export name to display all details from mounted ISO file.

From the main menu, the ISO Mount feature is located under "Storage". Please refer the figure below for reference.

Select on the ISO mount function and you will have the screen shot appear as following.

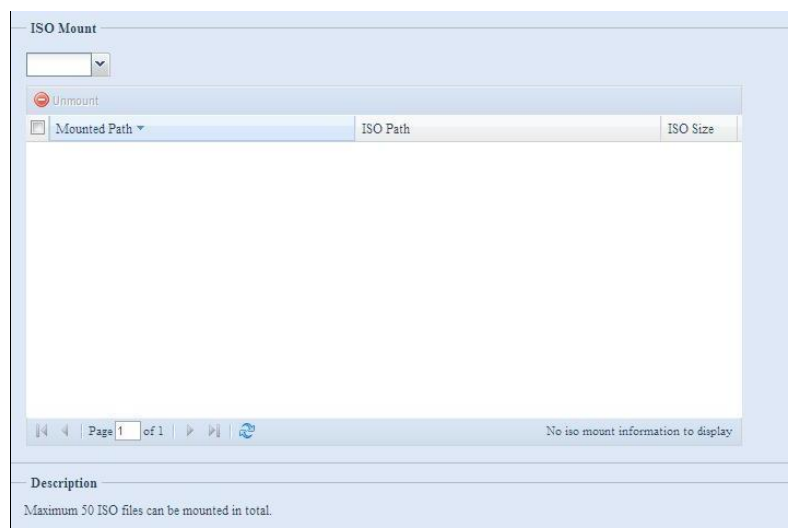

A. Add a ISO file

From the figure above, select ISO file from drop down share list.



After selection, system will bring up Mount table for further setting screen.

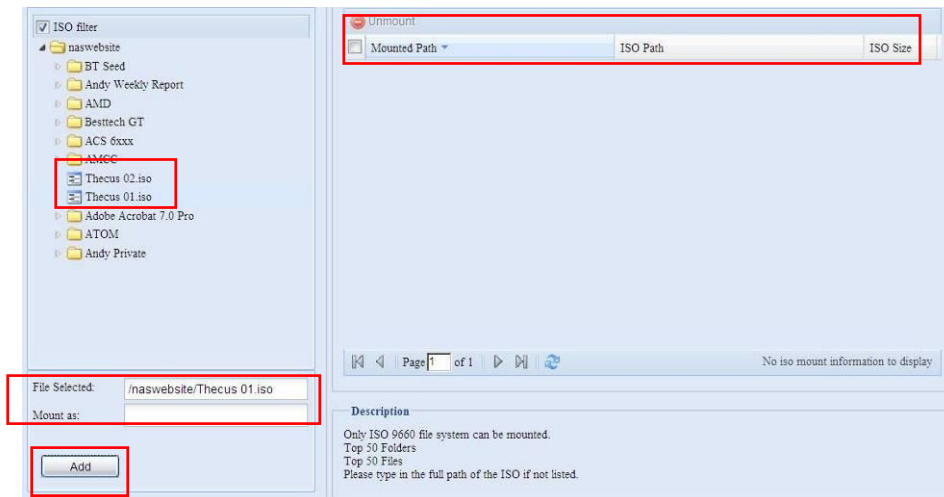
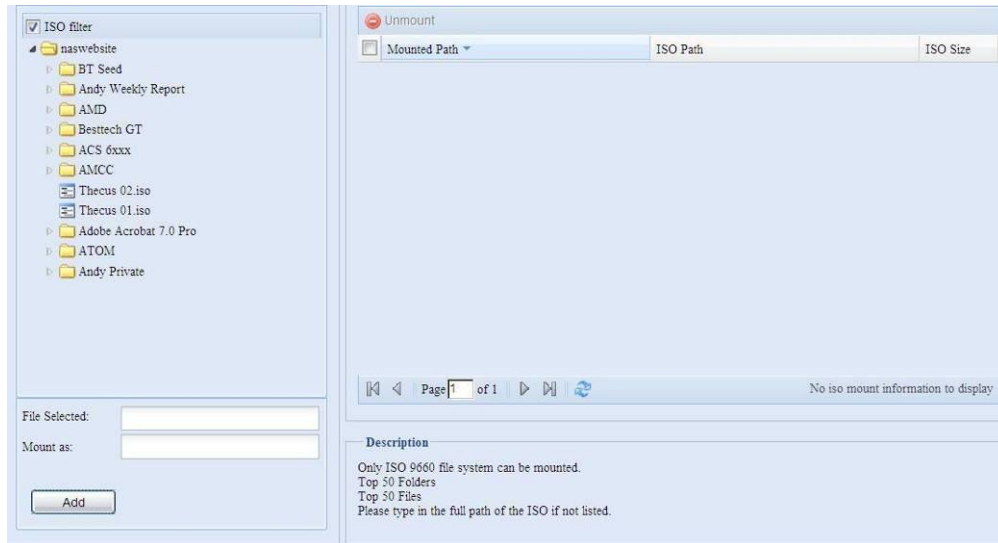

To mount new ISO file, select from listed ISO file and input desired mounting name into "Mount as:" field. Click "ADD" with confirmation to complete mounting ISO file. Or without "Mount as" ISO file export name input, system will automatic to give the export name by ISO file name.

If left "Mount as:" blink then system will create mount point by ISO file name.

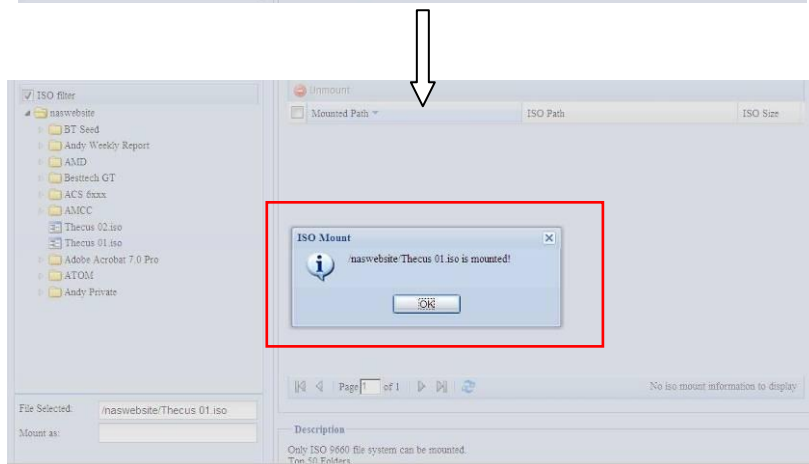
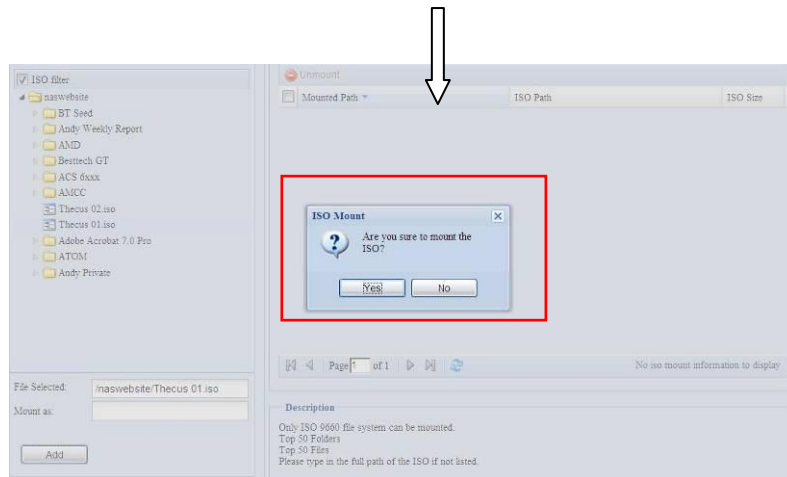

After you have completed to add ISO then the page will displayed all mounted ISO files,

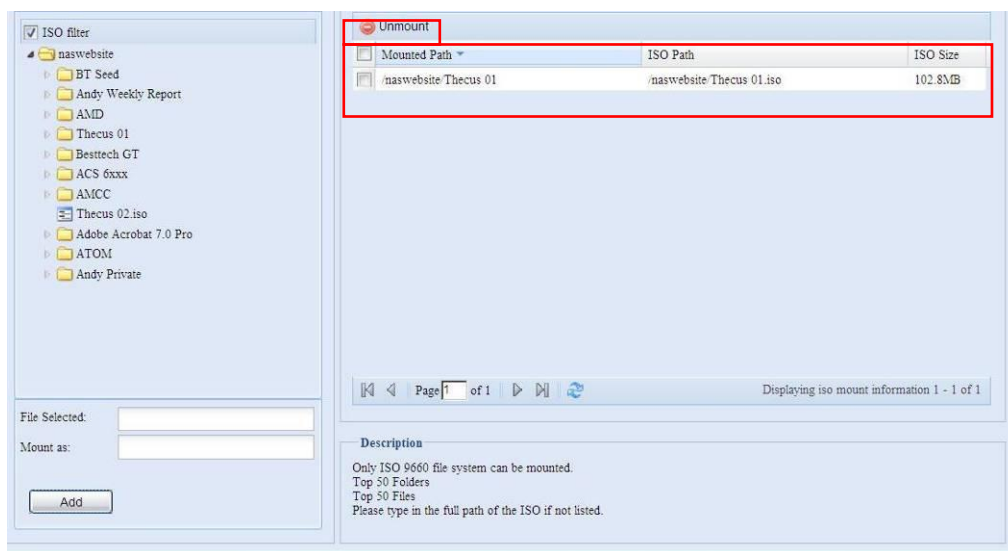

You could click "Unmount" to eliminate mounted ISO file.

B. Using ISO

The mounted ISO file will be located same share folder with name giving. Please refer the screen shot below.

ISO file "image" has mounted as folder "Image" you could see. The ISO file "Thecus 01" without assign mounting name, system automatically has folder "Thecus 01" created.

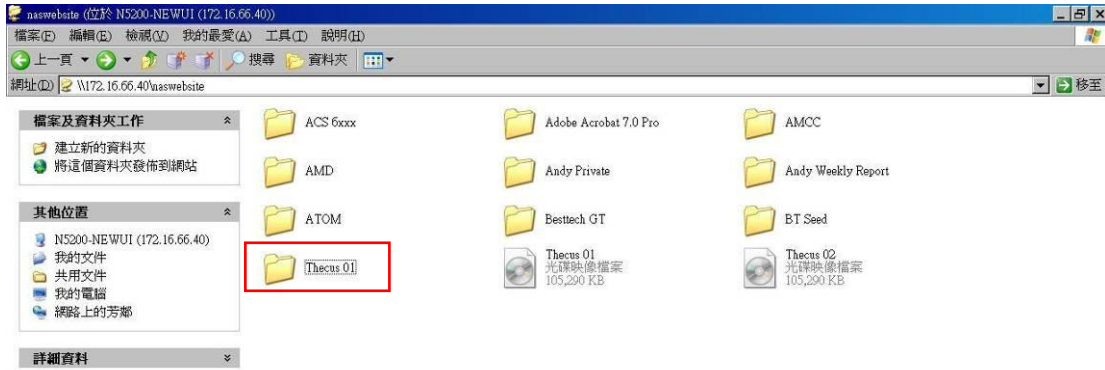

Share Folder

From the **Storage** menu, choose **Share Folder**, and the **Folder** screen appears. This screen allows you to create and configure folders on the Thecus IP storage volume.

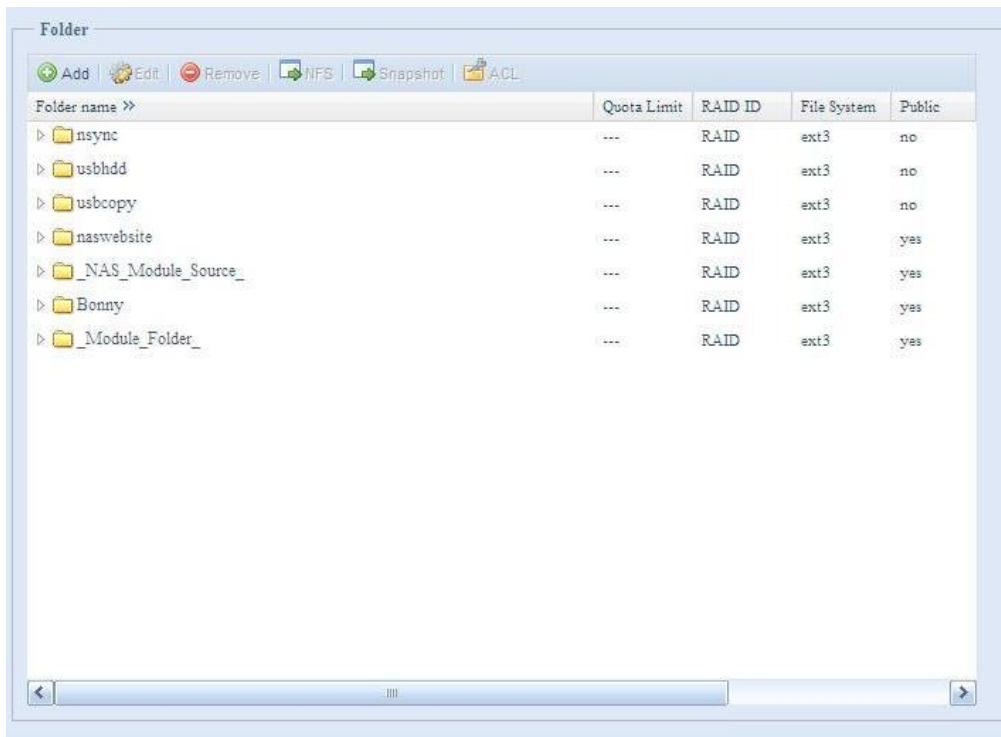

Adding Folders

On the **Folder** screen, press the **Add** button and the **Add Folder** screen appears. This screen allows you to add a folder. After entering the information, press **Apply** to create new folder.

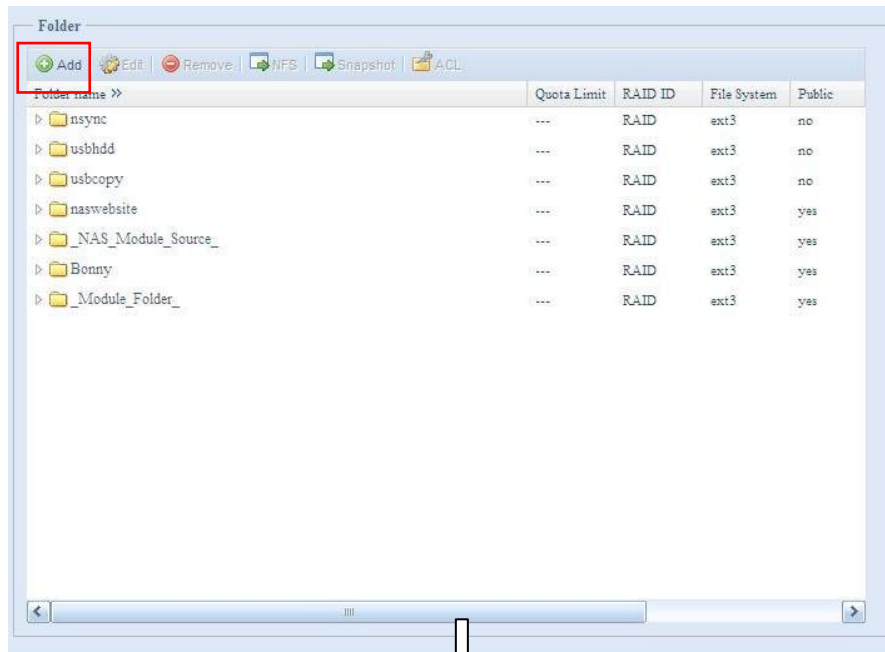

add folder

RAID ID: RAID

Folder name:

Description:

Browseable: Yes No

Public: Yes No

Share Folder Limit: GB

Add Folder	
Item	Description
RAID ID	RAID volume where the new folder will reside.
Folder Name	Enter the name of the folder.
Description	Provide a description the folder.
Browseable	Enable or disable users from browsing the folder contents. If Yes is selected, then the share folder will be browseable.
Public	Admit or deny public access to this folder. If Yes is selected, then users do not need to have access permission to write to this folder. When accessing a public folder via FTP, the behavior is similar to anonymous FTP. Anonymous users can upload/download a file to the folder, but they cannot delete a file from the folder.
Share Folder Limit	Enter the maximum size of the folder in Gigabytes (GB). The folder cannot grow beyond this limit. You can enter a 0 to turn off the share folder limit. This option did not apply while XFS file system selected.
Apply	Press Apply to create the folder.

NOTE

Folder names are limited to 60 characters. Systems running Windows 98 or earlier may not support file names longer than 15 characters.

Modify Folders

On the **Folder** screen, press the **Edit** button and the **Modify Folder** screen appears. This screen allows you to change folder information. After entering the information, press **Apply** to save your changes.

Modify Folder	
Item	Description
RAID ID	RAID volume where the folder will reside.
Folder Name	Enter the name of the folder.
Description	Provide a description the folder.
Browseable	Enable or disable users from browsing the folder contents. This setting will only apply while access via SMB/CIFS and web disk.
Public	Admit or deny public access to this folder.
Share Limit	Enter the maximum size of the folder. The folder will not grow beyond this limit. You can enter a 0 to turn off the share folder limit.

Remove Folders

To remove a folder, press the **Remove** button from the specified folder row. The system will confirm folder deletion. Press **Yes** to delete the folder permanently or **No** to go back to the folder list.

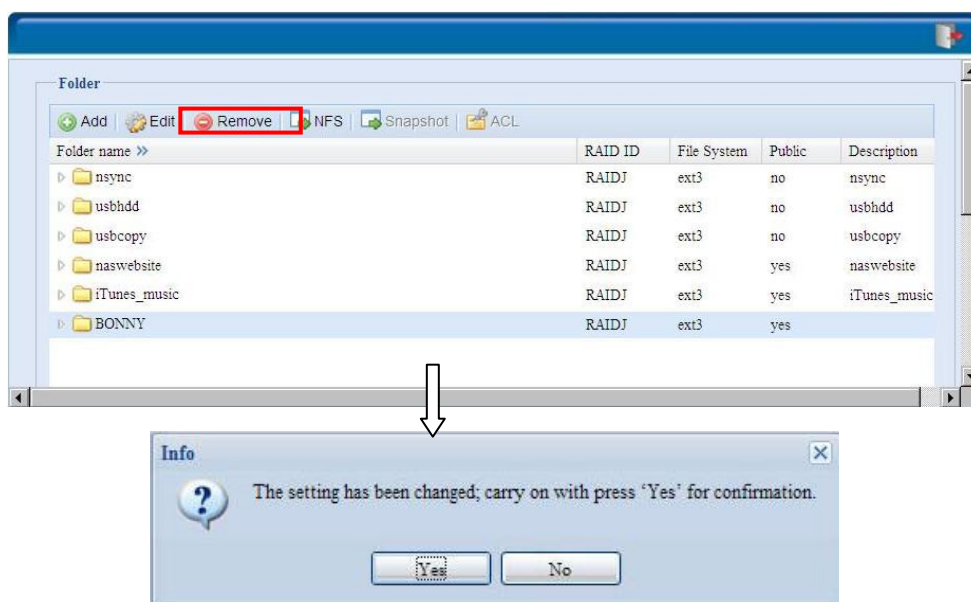

WARNING

All the data stored in the folder will be deleted once the folder is deleted.
The data will not be recoverable.

NFS Share

To allow NFS access to the share folder, enable the **NFS Service**, and then set up hosts with access rights by clicking **Add**.

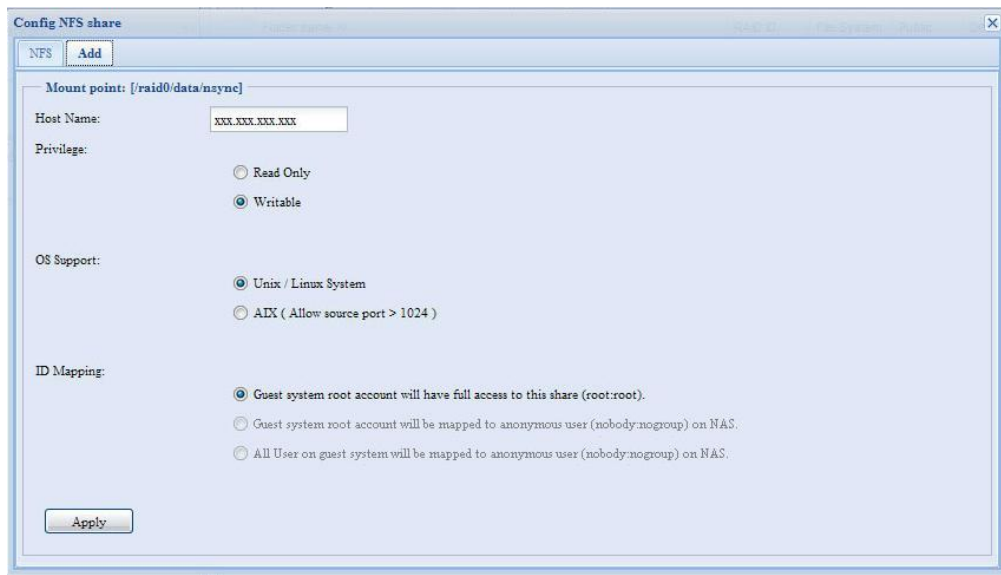
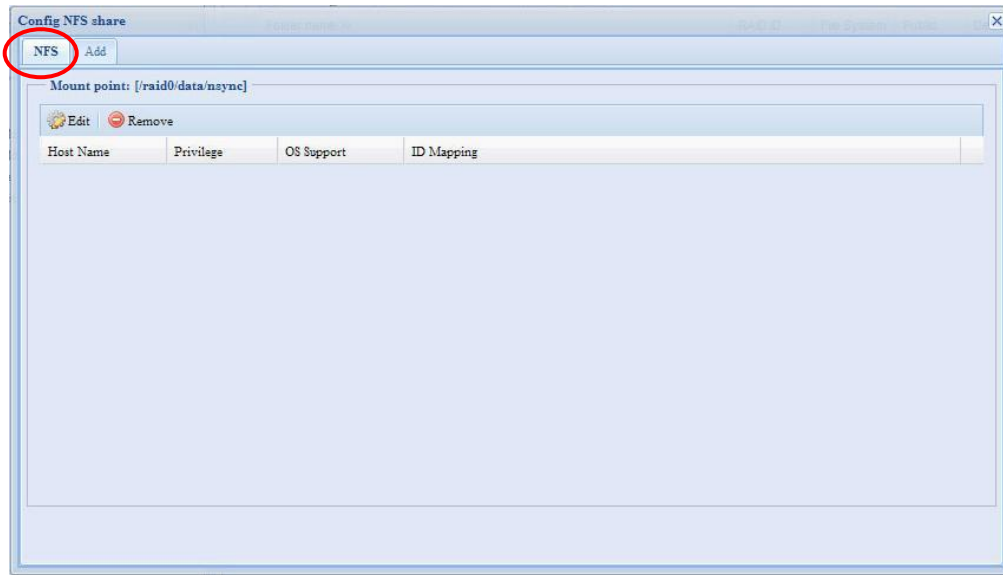

NFS Share	
Item	Description
Hostname	Enter the name or IP address of the host
Privilege	Host has either read only or writeable access to the folder.

Guest System Support	There are two selections available: <ul style="list-style-type: none"> • Unix / Linux System • AIX (Allow source port > 1024) Choose the one which best fits your needs.
IO Mapping	There are three selections available: <ul style="list-style-type: none"> • Guest system root account will have full access to this share (root:root). • Guest system root account will be mapped to anonymous user (nobody:nogroup) on NAS. • All user on guest system will be mapped to anonymous user (nobody:nogroup) on NAS. Choose the one which best fits your needs.
Apply	Click to save your changes.

Snapshot

The Thecus IP storage is capable for 16 snapshot version control. To have snapshot to work on, the file system creation for RAID volume has to be "ZFS".

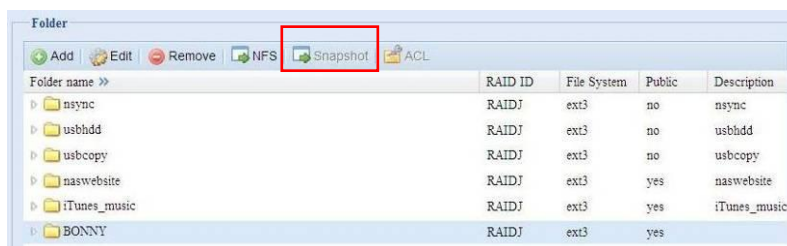

Snap (Snapshot configuration)

If added folder has located in the RAID volume with "ZFS" file system, then the folder management screen with "Snap" button will be configurable.

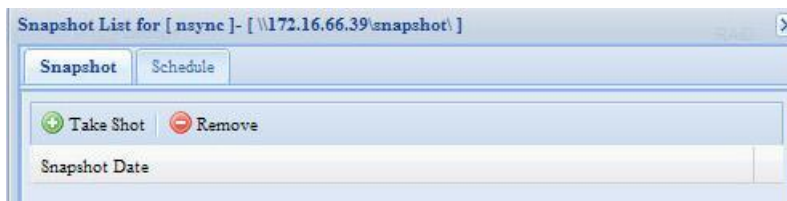

Snapshot	
Item	Description
Take Shot	Click to take snapshot right away.
Remove	Click to remove snapshot schedule.
Schedule	Click to open snapshot schedule setup screen.

Clicking on schedule button then schedule setup screen appear. Checked the enable check box to activate the snapshot scheduled operation.

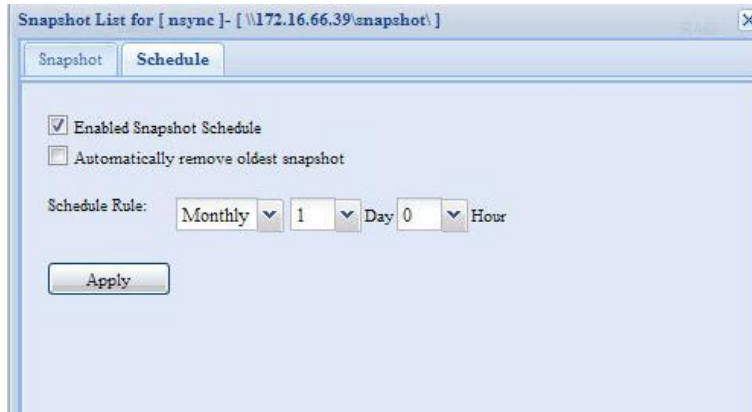

The Thecus IP storage snapshot is supported total **16 versions**. Once checked "Automatically remove oldest snapshot", the oldest will be removed to let newest to added on top. Otherwise, if the check box is unchecked and snapshot versions are up to 16 then system will appear warning message and won't execute the task till available version count.

The snapshot schedule rules can be setup for monthly, weekly or daily.

Clicking on **Apply** after firmed with desired schedule

These taken snapshot is only accessible though CIFS/SMB by manually type **\\NAS IP address\snapshot** and invisible from normal access. Also, the taken snapshot version is read only can not be deleted under CIFS/SMB access but only click the "Del" button showing on the screen shot above.

Folder and sub-folders Access Control List (ACL)

On the Folder screen, press the **ACL** button, and the **ACL setting** screen appears. This screen allows you to configure access to the specific folder and sub-folders for users and groups. Select a user or a group from the left hand column and then choose **Deny**, **Read Only**, or **Writable** to configure their access level. Press the **Apply** button to confirm your settings.

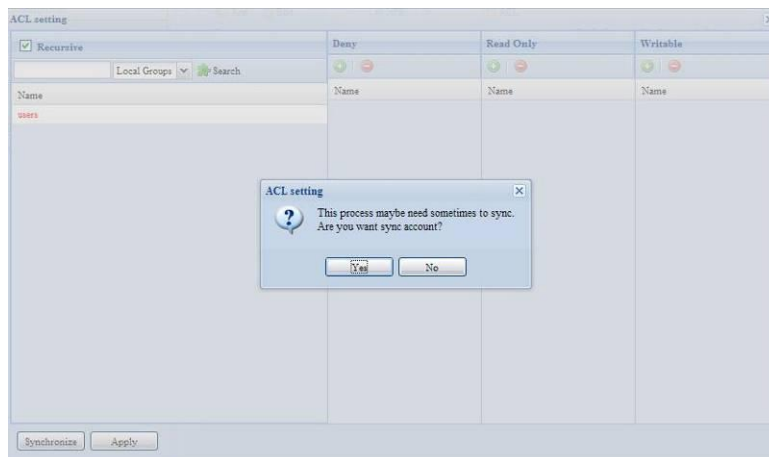

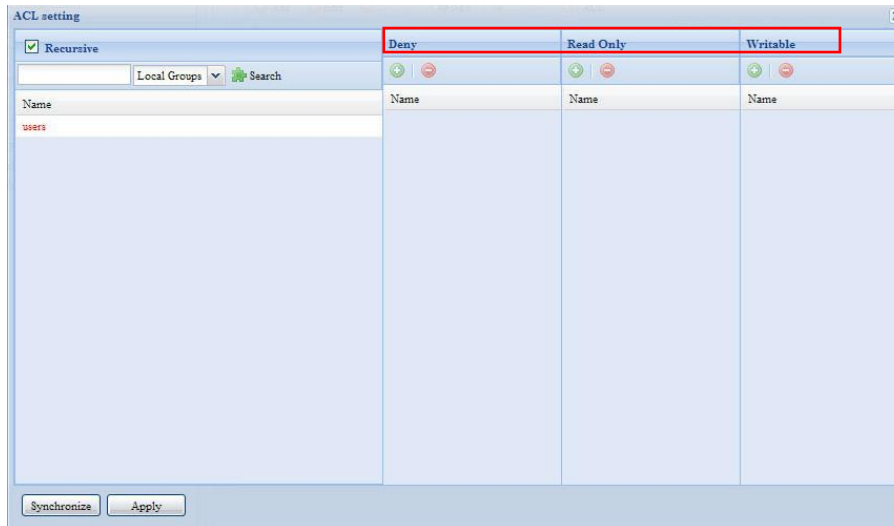

ACL setting	
Item	Description
Deny	Denies access to users or groups who are displayed in this column.
Read Only	Provides Read Only access to users or groups who are displayed in this column.
Writable	Provides Write access to users or groups who are displayed in this column.
Recursive	Enable to inherit the access right for all its sub-folders.

To configure folder access, follow the steps below:

1. On the **ACL** screen, all network groups and users are listed in the left hand column. Select a group or user from this list.
2. With the group or user selected, press one of the buttons from the three access level columns at the top. The group or user then appears in that column and has that level of access to the folder.
3. Continue selecting groups and users and assigning them access levels using the column buttons.
4. To remove a group or user from an access level column, press the **Remove**  button in that column.
5. When you are finished, press **Apply** to confirm your ACL settings.

NOTE

If one user has belonged to more than one group but different privilege than the priority Deny > Read Only > Writable

To setup sub-folders ACL, click on "▶" symbol to extract sub folders list as screen shot shows below. You may carry on with same steps as share level ACL setting.

Folder name >>	RAID ID	File System	Public	Description
▷ nsync	aaaa	ext3	no	nsync
▷ usbhdd	aaaa	ext3	yes	usbhdd
▷ usbcopy	aaaa	ext3	no	usbcopy
▷ naswebsite	aaaa	ext3	no	naswebsite
▷ iTunes_music	aaaa	ext3	yes	iTunes_music
▷ test	aaaa	ext3	yes	
▶ test1	aaaa	ext3	no	
▷ ECR			no	
▷ NetBench			no	

NOTE

The ACL can be set for share and sub-folders level, not for files.

The ACL screen also allows you to search for a particular user. To do this, follow the steps below:

1. In the blank, enter the name of the user you would like to find.
2. From the drop down select the group you would like to search for the user in.
3. Click **Search**.

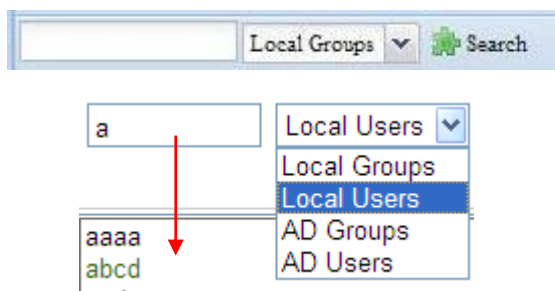

NOTE

The system will list up to 1,000 users from the chosen category. To narrow your search, enter a search term in the blank provided.

User and Group Authentication

Thecus IP storage has built-in user database that allows administrators to manage user access using different group policies. From the **User and Group Authentication** menu, you can create, modify, and delete users, and assign them to groups that you designate.



ADS/NT Support

If you have a Windows Active Directory Server (ADS) or Windows NT server to handle the domain security in your network, you can simply enable the ADS/NT support feature; the Thecus IP storage will connect with the ADS/NT server and get all the information of the domain users and groups automatically. From the **Accounts** menu, choose **Authentication** item and the **ADS/NT Support** screen appears. You can to change any of these items and press **Apply** to confirm your settings.

A description of each item follows:

ADS/NT Support	
Item	Description
Work Group / Domain Name	Specifies the SMB/CIFS Work Group / ADS Domain Name (e.g. MYGROUP).
ADS/NT Support	Select Disable to disable authentication through Windows Active Directory Server or Windows NT.
Authentication Method	Select ADS for Windows Active Directory Server, or select NT for Windows NT
ADS/NT Server Name	Specifies the ADS/NT server name (e.g. adservername).
ADS/NT Realm	Specifies the ADS/NT realm (e.g. example.com).
Administrator ID	Enter the administrators ID of Windows Active Directory or Windows NT, which is required for Thecus IP storage to join domain.
Administrator Password	Enter the ADS/NT Administrator password.
Apply	To save your settings.

To join an AD domain, you can refer the figure and use the example below to configure the Thecus IP storage for associated filed input:

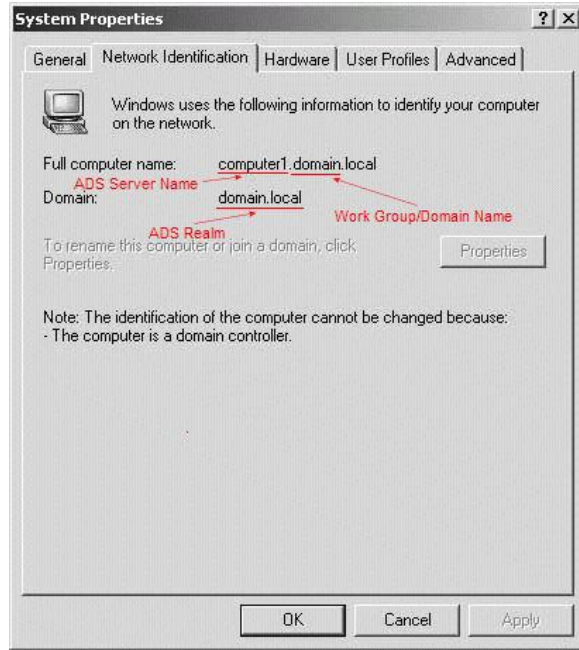

AD Domain Example	
Item	Information
Work Group / Domain Name	domain
ADS Support	Enable
ADS Server Name	Computer1
ADS/NT Realm	Domain.local
Administrator ID	Administrator
Administrator Password	*****

NOTE

- The DNS server specified in the WAN/LAN1 configuration page should be able to correctly resolve the ADS server name.
- The time zone setting between Thecus IP storage and ADS should be identical.
- The system time difference between Thecus IP storage and ADS should be less than five minutes.
- The Administrator Password field is for the password of ADS (Active Directory Server) not Thecus IP storage.

Local User Configuration

From the **Accounts** menu, choose the **User** item, and the **Local User Configuration** screen appears. This screen allows you to **Add**, **Edit**, and **Remove** local users.

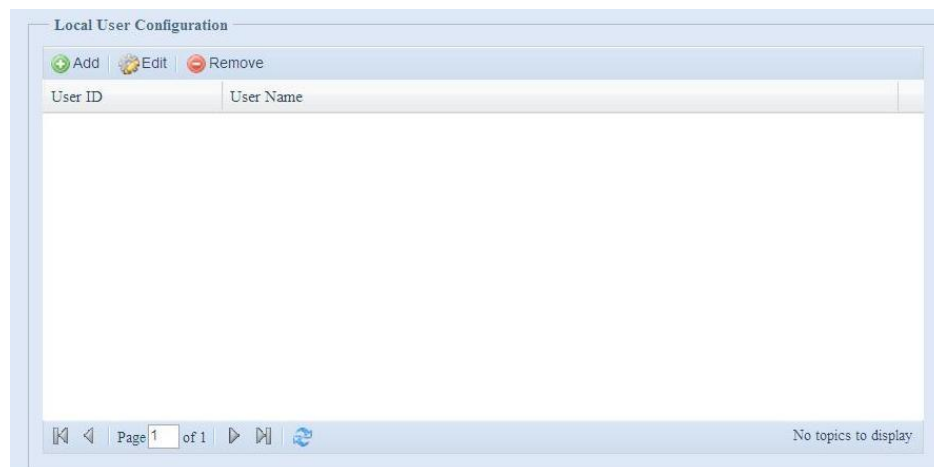

Local User Configuration	
Item	Description
Add	Press the Add button to add a user to the list of local users.
Edit	Press the Edit button to modify a local user.
Remove	Press the Remove button to delete a selected user from the system.

Add Users

1. Click on the **Add** button on **Local User Configuration** screen, and **Local User Setting** screen appears.
2. On the **Local User Setting** screen, enter a name in the **User Name** box.
3. Enter a **User ID** number. If left blank, the system will automatically assign one.
4. Enter a password in the **Password** box and re-enter the password in the **Confirm** box.
5. Select which group the user will belong to. **Group Members** is a list of groups this user belongs to. **Group List** is a list of groups this user does not belong to. Use the << or >> buttons to have this user join or leave a group.
6. Press the **Apply** button and the user is created.

Add

Local User Setting

User Name:

User ID:

Password:

Confirm Password:

Group Members

GroupID	Group Name
102	users

Group List

Search:

GroupID	Group Name
---------	------------

Apply

NOTE

All users are automatically assigned to the 'users' group.

Edit Users

1. Select an existing user from the **Local User Configuration** screen.
2. Click on the **Edit** button, and **Local User Setting** screen appears.
3. From here, you can enter a new password and re-enter to confirm, or use the **<<** or **>>** buttons to have this user join or leave a group. Click the **Apply** button to save your changes.

Edit

Local User Setting

User Name:

User ID:

Password:

Confirm Password:

Group Members

GroupID	Group Name
102	users

Group List

Search:

GroupID	Group Name
---------	------------

Apply

Remove Users

1. Select an existing user from the **Local User Configuration** screen.
2. Click on **Remove** button and the user is deleted from the system.

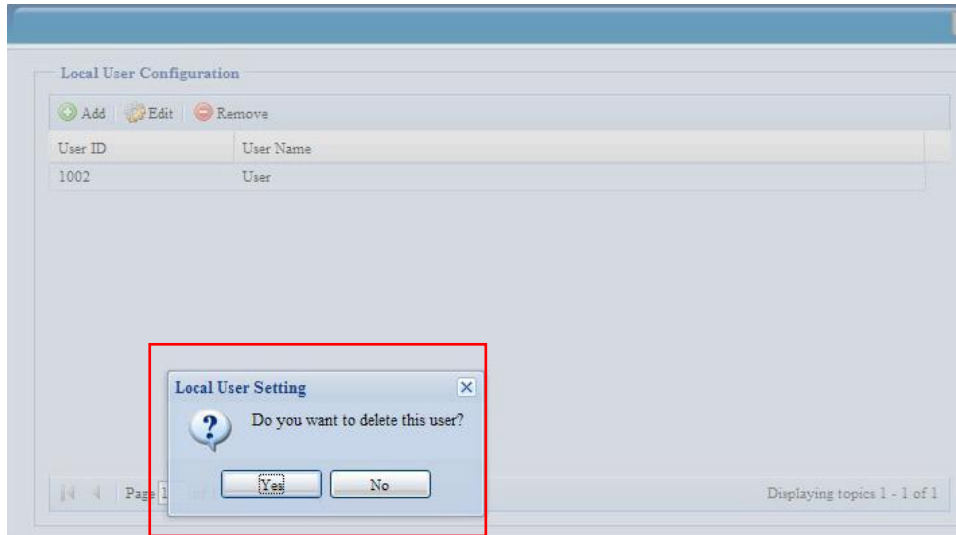

Local Group Configuration

From the **Accounts** menu, choose the **Group** item, and the **Local Group Configuration** screen appears. This screen allows you to **Add**, **Edit**, and **Remove** local groups.

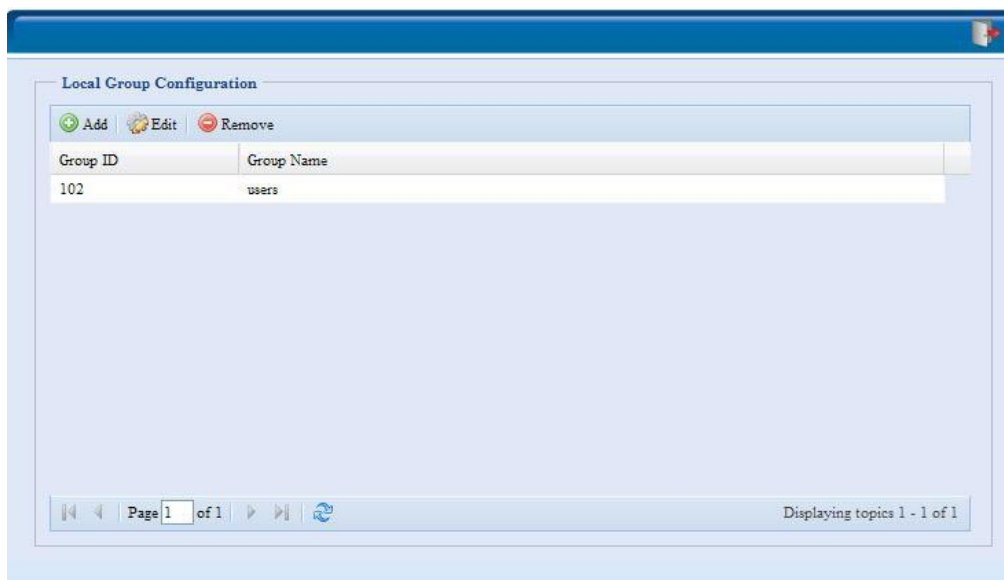

Local Group Configuration	
Item	Description
Add	Press the Add button to add a user to the list of local groups.
Edit	Press the Edit button to modify a selected group from the system.
Remove	Press the Remove button to delete a selected group from the system.

Add Groups

1. On the **Local Group Configuration** screen, click on the **Add** button.
2. The **Local Group Setting** screen appears.
3. Enter a **Group Name**.
4. Enter a **Group ID** number. If left blank, the system will automatically assign one.
5. Select users to be in this group from the **Users List** by adding them to the **Members List** using the << button.
6. Click the **Apply** button to save your changes.

The screenshot shows a dialog box titled "Add" with a close button (X) in the top right corner. It is divided into two main sections: "Local Group Setting" on the left and "Users List" on the right. At the bottom, there is an "Apply" button.

Local Group Setting

Group Name:

Group ID:

Members List

UserID	User Name
--------	-----------

Users List

Search:

UserID	User Name
1002	User

Edit Groups

1. On the **Local Group Configuration** screen, select a group name from the list.
2. Press the **Edit** button to modify the members in a group.
3. To add a user into a group, select the user from the **Users List**, and press the << button to move the user into the **Members List**.
4. To remove a user from a group, select the user from **Members List**, and press the >> button.
5. Click the **Apply** button to save your changes.

The screenshot shows a dialog box titled "Edit" with a close button (X) in the top right corner. It is divided into two main sections: "Local Group Setting" on the left and "Users List" on the right. At the bottom, there is an "Apply" button.

Local Group Setting

Group Name:

Group ID:

Members List

UserID	User Name
--------	-----------

Users List

Search:

UserID	User Name
1002	User

Remove Groups

1. On the **Local Group Configuration** screen, select a group name from the list.
2. Press **Remove** to delete the group from the system.

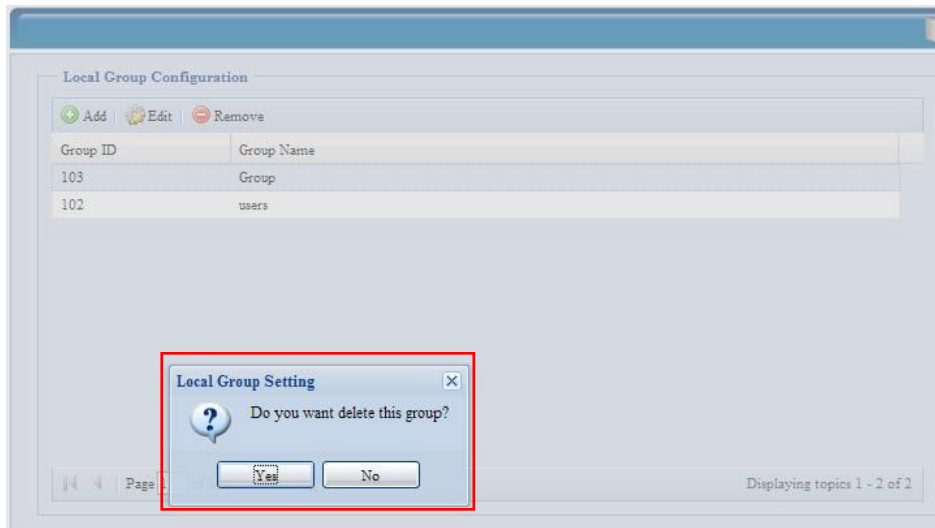

Batch Create Users and Groups

ThecUS IP storage can also add users and groups in batch mode. This enables you to conveniently add numerous users and groups automatically by importing a simple comma-separated plain text (*.txt) file.

From the **Accounts** menu, click **Batch Mgmt** and the **Batch Create Users and Groups** dialogue will appear. To import your list of users and groups, follow these steps:

1. Click **Browse...** to locate your comma-separated text file.
The information in the text file should follow this format:

```
[USERNAME], [PASSWORD], [GROUP]
```
2. Click **Open**.
3. Click **Import** to begin the user list import.

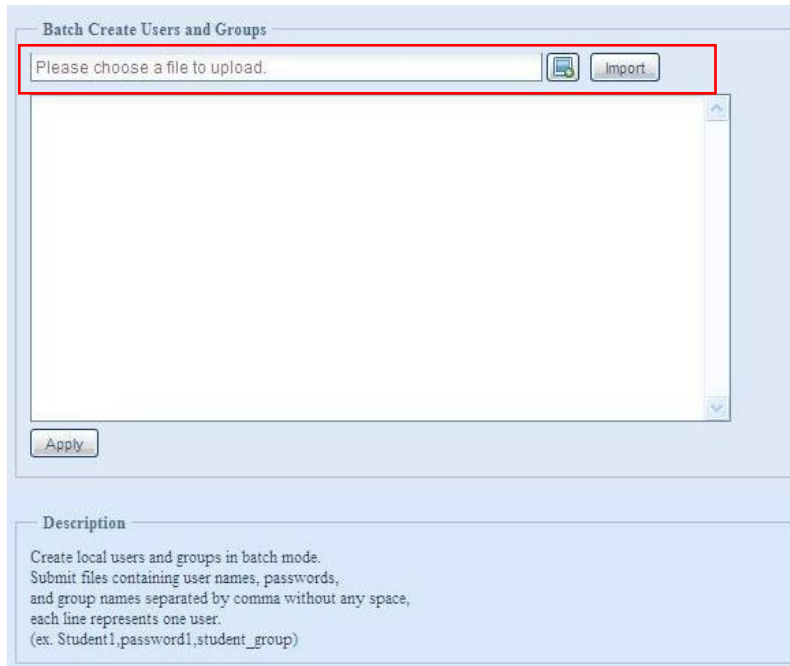

Quota

The User Quota system provides a way of limiting users' available storage capacity. Setting a user quota gives a given user a given amount of space on EACH RAID partition. For example, if there are 3 RAID partitions and a user has a user quota of 300MB, the user can store 300MB of data on EACH RAID partition, or a total of 900MB of data. The framework keeps track of the total amount of data a user has used across different folders and functions such as the photo server.

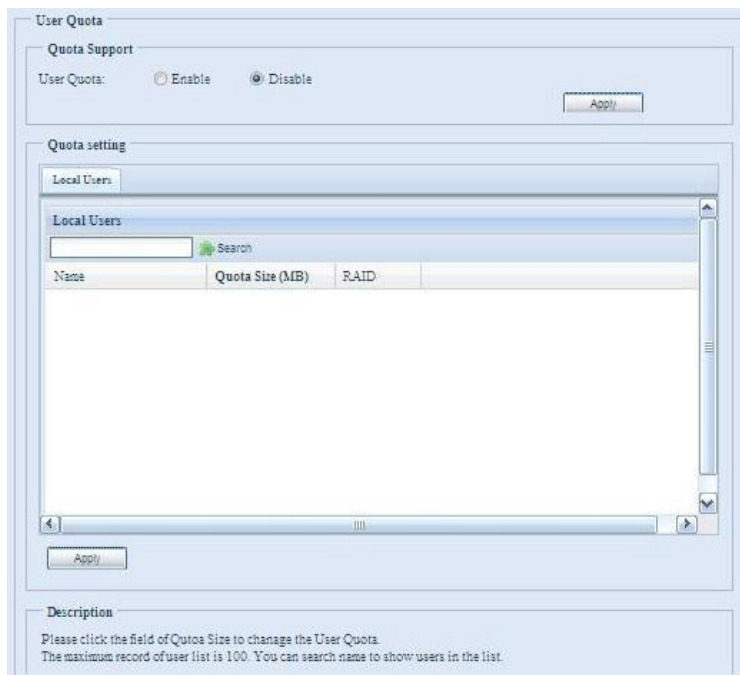

Network Service

Setup and manage protocols such as Samba/CIFS, FTP, and HTTP/Web Disk, and other network services.



Samba / CIFS

There are 5 options is currently allow Admin to Enable/Disable to operate Thecus IP storage associated with Samba / CIFS protocol. With the option changed, it will need to reboot system to activate.

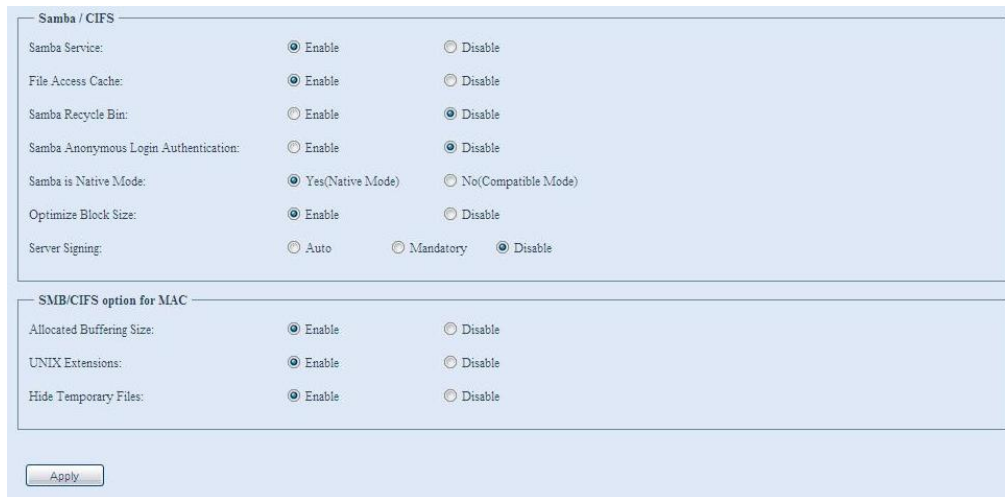

Samba / CIFS		
Samba Service:	<input checked="" type="radio"/> Enable	<input type="radio"/> Disable
File Access Cache:	<input checked="" type="radio"/> Enable	<input type="radio"/> Disable
Samba Recycle Bin:	<input type="radio"/> Enable	<input checked="" type="radio"/> Disable
Samba Anonymous Login Authentication:	<input type="radio"/> Enable	<input checked="" type="radio"/> Disable
Samba is Native Mode:	<input checked="" type="radio"/> Yes(Native Mode)	<input type="radio"/> No(Compatible Mode)
Optimize Block Size:	<input checked="" type="radio"/> Enable	<input type="radio"/> Disable
Server Signing:	<input type="radio"/> Auto	<input type="radio"/> Mandatory <input checked="" type="radio"/> Disable
SMB/CIFS option for MAC		
Allocated Buffering Size:	<input checked="" type="radio"/> Enable	<input type="radio"/> Disable
UNIX Extensions:	<input checked="" type="radio"/> Enable	<input type="radio"/> Disable
Hide Temporary Files:	<input checked="" type="radio"/> Enable	<input type="radio"/> Disable
<input type="button" value="Apply"/>		

Samba Service

Used for letting the operating system of UNIX series and SMB/CIFS of Microsoft Windows operating system (Server Message Block / Common Internet File System).Do the link in network protocol. Enable or Disable SMB/CIFS protocol for Windows, Apple, Unix drive mapping.

NOTE

- In some environments, due to security concerns, you may wish to disable SMB/CIFS as a precaution against computer viruses.

File Access Cache

File Access Cache is default **Enable**. This option will help to increase the performance while single client access share folder in writing under SMB/CIFS protocol.

Samba Recycle Bin

The Thecus IP storage is supported recycle bin via SMB/CIFS protocol. Simply enable it then all of deleted files/folders will reside in the ".recycle" folder with hidden attribution in each share.



In general, Windows has default to invisible all of hidden folders/files. So please enable this option to view “.recycle” folder.

Samba Anonymous Login Authentication

To enable this option, no matter there is share folder has been created in public access. The user account and password is needed from system to access under SMB/CIFS protocol. On the other hand, no more anonymous login is allowed.

Samba is Native mode

The Thecus IP storage is supported Samba mode options. In the ADS environment with “Native” mode selected then Thecus IP storage is capable to become local master position.

UNIX Extension

The default is enable for Samba usage, with situation using Mac OSX with smb connection may have permission issue. When it happened, please setup “UNIX Extension” disable to get issue solved.

AFP (Apple Network Setup)

From the **Network Service** menu, choose the **AFP** item, and the **AFP Support** screen appears. This screen displays the configuration items for the Apple Filing Protocol. You can change any of these items and press **Apply** to confirm your settings.



A description of each item follows:

Apple Network Configuration	
Item	Description
AFP Server	Enable or disable Apple File Service to use Thecus IP storage with MAC OS-based systems.
MAC CHARSET	Specifies the code page from drop down list
Zone	Specifies Zone for Appletalk service. If your AppleTalk network uses extended networks and is assigned with multiple zones, assign a zone name to Thecus IP storage. If you do not want to assign a network zone, enter an asterisk (*) to use the default setting.
Time Machine	Enable checked box while you like to backup you MAC system to have Thecus IP storage as MAC time machine

NFS Setup

From the **Network Service** menu, choose the **NFS** item, and the **NFS Support** screen appears. The Thecus IP storage can act as an NFS server, enabling users to download and upload files with the favorite NFS clients. Press **Apply** to confirm your settings.



A description of each item follows:

NFS Server Setting	
Item	Description
NFS	Enable or Disable NFS support.
Apply	Click Apply to save your changes.

FTP

Thecus IP storage can act as a FTP server, enabling users to download and upload files with their favorite FTP programs. From the **Network Service** menu, choose the **FTP** item, and the **FTP** screen appears. You can change any of these items and press **Apply** to confirm your settings.

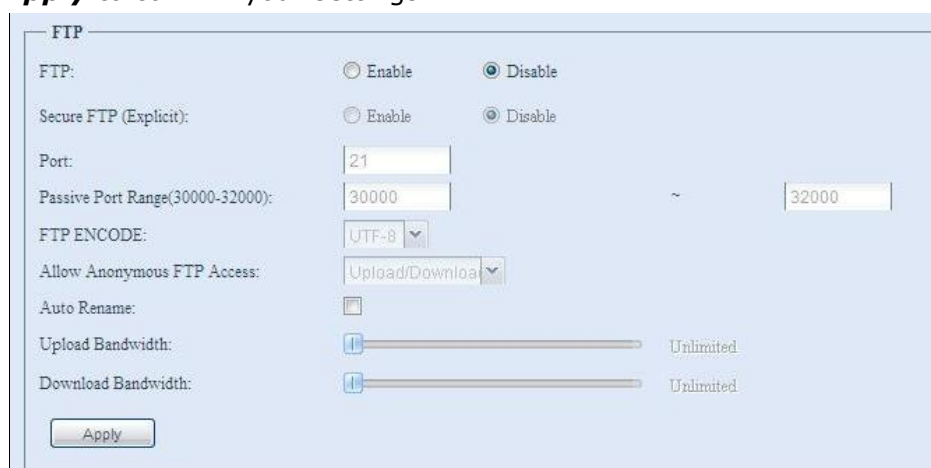

A description of each item follows:

FTP	
Item	Description
FTP	Enable FTP Service on Thecus IP storage.
Security FTP	Enable or disable Security FTP, be sure the client FTP software has also security FTP setting enabled.
Port	Specifies the port number of an incoming connection on a non-standard port.
Passive Port Range (30000-32000)	limited port range for the FTP server to use.
FTP ENCODE	If your FTP client or operating system does not support Unicode (e.g. Windows® 95/98/ME or MAC OS9/8), select the same encoding as your OS here in order to properly view the files and directories on the server. Available options are BIG5, HZ, GB2312, GB18030, ISO, EUC-JP, SHIFT-JIS and UTF-8.
Allow Anonymous FTP	Upload/Download: Allow anonymous FTP users to upload or

Access	download files to/from public folders. Download: Allow anonymous FTP users to download files from public folders. No access: Block anonymous FTP user access.
Auto Rename	If checked, the system will automatically rename files that are uploaded with a duplicate file name. The renaming scheme is [filename].#, where # represents an integer.
Upload Bandwidth	You may set the maximum bandwidth allocated to file uploads. Selections include Unlimited, 1, 2, 4, 8, 16 and 32 MB/s.
Download Bandwidth	You may set the maximum bandwidth allocated to file downloads. Selections include Unlimited, 1, 2, 4, 8, 16 and 32 MB/s.

To access the share folder on Thecus IP storage, use the appropriate user login and password set up on the **Users** page. Access control to each share folder is set up on the **ACL** page (**Storage Management > Share Folder > ACL**).

TFTP

Thecus IP storage can act as a TFTP server, enabling users to download and upload files with their favorite TFTP programs. From the **Network Service** menu, choose the **TFTP** item, and the **TFTP** screen appears. You can change any of these items and press **Apply** to confirm your settings.

A description of each item follows:

FTP	
Item	Description
TFTP	Enable TFTP Service on the Thecus IP storage.
IP	Checked WAN/LAN1 or LAN2 to enable port use
Port	Specifies the port number of an incoming connection on a non-standard port.
Share Folder	Select the file stored folder, it can not be empty.
Folder Permission	Select the folder permission

HTTP/ Web Disk

From the **Network Service** menu, choose the **HTTP/ Web Disk** item, and the **Web Disk (HTTP) Support** screen appears. This screen displays the service support parameters of the system. You can change any of these items and press **Apply** to confirm your settings.

WebDisk (HTTP) Support

Sharing: Enable Disable

Port:

Secure WebDisk (Secure HTTP) Support

Sharing: Enable Disable

Port:

CertificateFile:

CertificateKeyFile:

CACertificateFile:

Description

1. Please insert SSL Certificate file while Secure WebDisk enabled or default will be used while file error occurred.
 2. The SSL Certificate file needs to reload while master RAID has changed.

A description of each item follows:

Web Service	
Item	Description
HTTP (WebDisk) Support	Enable or disable WebDisk support. Enter the port number if this option is enabled. The port number is default 80.
HTTPs (Secure WebDisk) Support	Enable or disable secure WebDisk support. Enter the port if this option is enabled.

NOTE

- Disable HTTP support and Enable Secure HTTP support to guarantee secure access.

UPnP

This device supports UPnP Media server, which allows users to play media files with UPnP client (ex. DMA devices). Enable or disable Universal Plug and Play protocol. UPnP helps to find the IP address of Thecus IP storage.

UPnP

UPnP: Enable Disable

Description:

Bonjour Setting

Bonjour, is Apple Inc.'s trade name for its implementation of Zeroconf, a service discovery protocol. Bonjour locates devices such as printers, as well as other computers, and the services that those devices offer on a local network using multicast Domain Name System service records. This definitive guide walks you through Bonjour zero-configuration networking with a complete description of the protocols and technologies used to create Bonjour enabled applications and devices.

Bonjour Setting

Bonjour service: Enable Disable

Application Server

Thecus IP storage support iTunes server functionality, Module Installation, and Auto Module Installation. The iTunes server function allows you to play music files from your NAS through iTunes on your computer. The following section shows you how.



iTunes® Server

With the built-in iTunes server capability, Thecus IP storage enables digital music to be shared and played anywhere on the network!

From the **Application Server** menu, choose the **iTunes** item, and the **iTunes Configuration** screen appears. You may enable or disable the iTunes Service from here. Once enabled, enter correct information for each field and press **Apply** to save your changes.

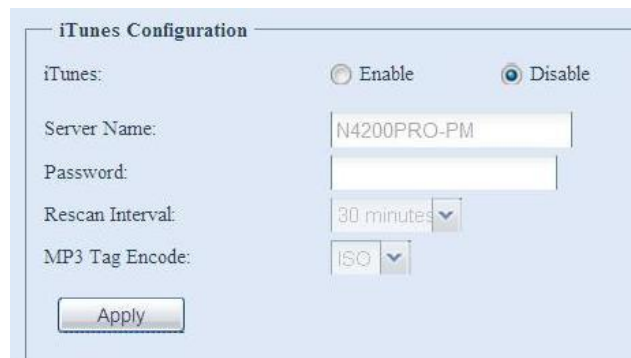
A screenshot of the "iTunes Configuration" web form. It features a title bar "iTunes Configuration" and several fields: "iTunes:" with radio buttons for "Enable" and "Disable" (the "Disable" button is selected); "Server Name:" with a text input field containing "N4200PRO-PM"; "Password:" with a text input field; "Rescan Interval:" with a dropdown menu set to "30 minutes"; and "MP3 Tag Encode:" with a dropdown menu set to "ISO". An "Apply" button is located at the bottom left of the form.

See the following table for detailed descriptions of each field:

iTunes Configuration	
Item	Description
iTunes	Enable or disable the iTunes Service.
Server Name	Name used to identify Thecus IP storage to iTunes clients.
Password	Enter password to control access to your iTunes music.
Rescan Interval	Rescan interval in seconds.
MP3 Tag Encode	Specify tag encoding for MP3 files stored in Thecus IP storage. All ID3 tags will be sent out in UTF-8 format.

Once the iTunes service is enabled, Thecus IP storage will make all music located in the **Music** folder available for iTunes-equipped computers on the network.

Module Installation

From the **Application Server** menu, choose the **Module Installation** item and the **Module Management** screen appears. From here, you can install separate software modules to extend the functionality of your Thecus IP storage.

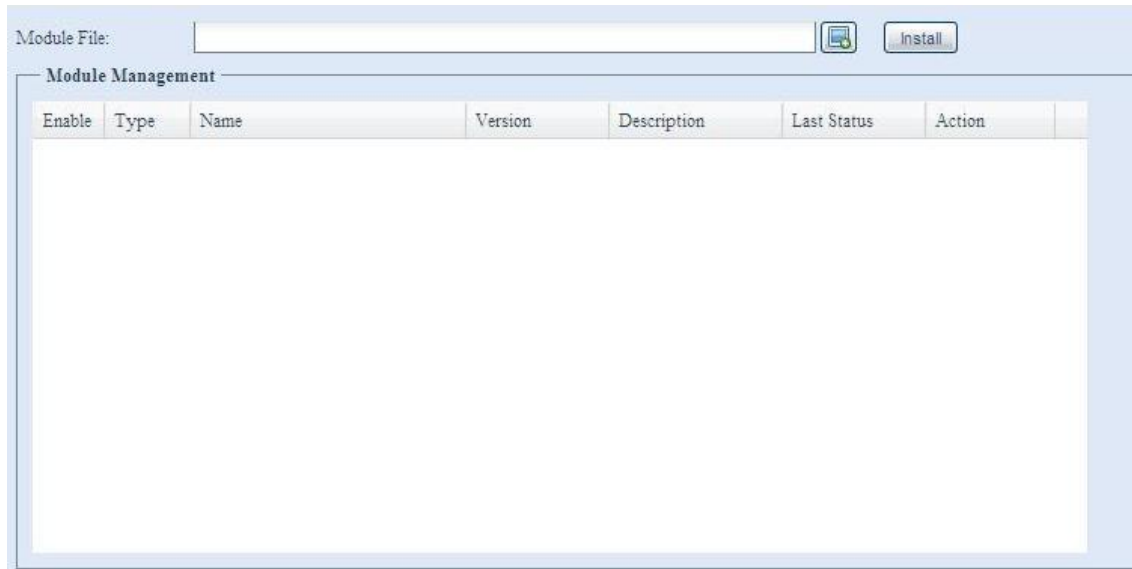

Auto Module Installation

Or choose the **Auto Module Installation** item and the **available system Module** screen appears. The default to get module list is "On-line" so if Thecus IP storage is capable to connect to Internet then it will automatically link to Thecus official website then list available modules. Please refer the screen shot below.

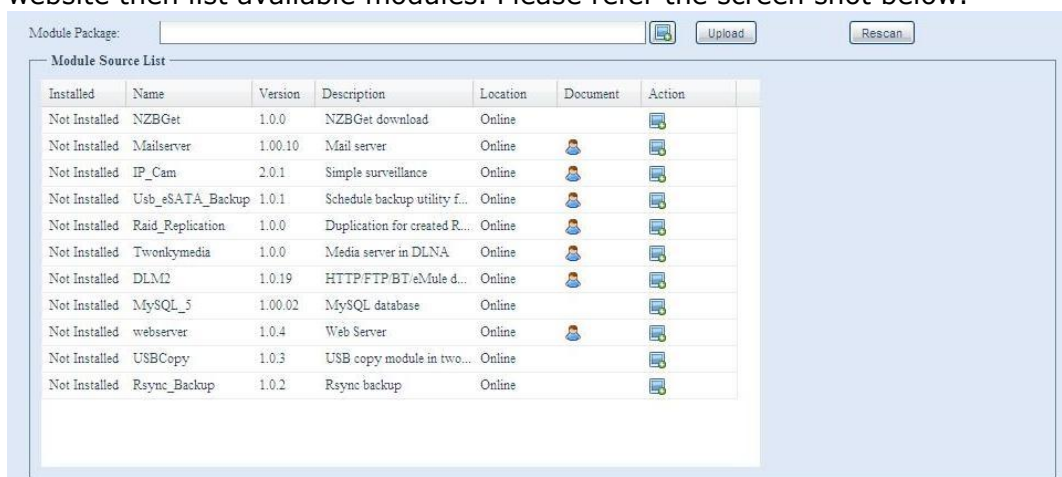

The other way to have auto module installed is using universal CD shipped with system. It has contained file "modules.zip" which included all modules while system shipped. Please refer the screenshot below.

NOTE

The modules list getting on-line of Thecus website will newly than "thecus.zip" from shipped CD. But the installation from Thecus website could have unpredictable duration due to bandwidth concern.

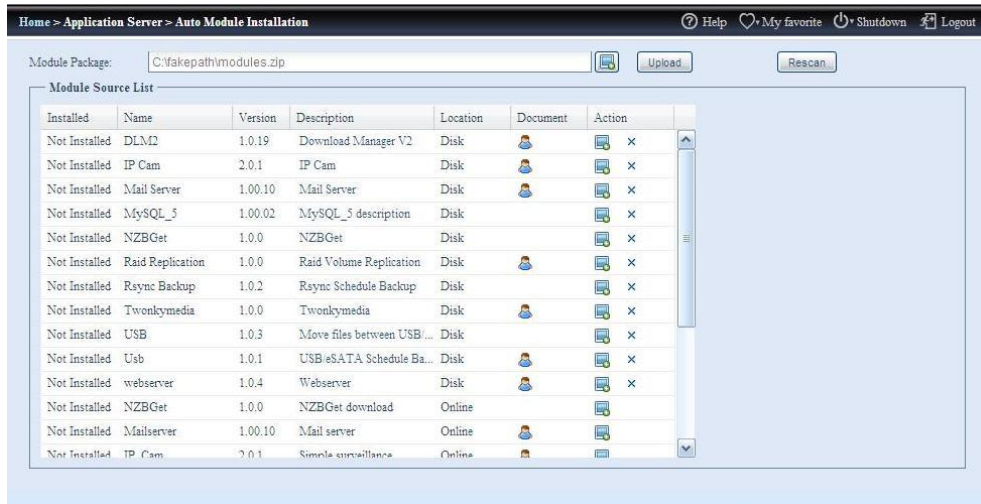

Auto Module Source List	
Item	Description
Installed	Status of module
Name	Module name
Version	The version of released version
Description	The description of module
Location	The module is either getting on-line or disk
Document	The available documentation of module
Action	To install module or deleted p.s. If module list from on-line, then no delete option available
Rescan	Click to rescan from both on-line and disk

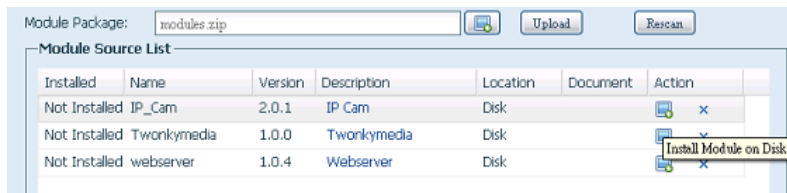

After click on "Action" to install module, the module will be under list of Module Installation. Please do "Enable" to activate module usage.

Backup

There are a number of ways to back up data with the Thecus IP storage.

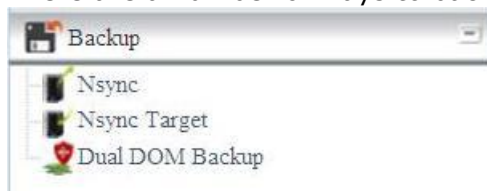

Nsync (Does not apply to the 3x series)

You can backup a share folder to another Thecus IP storage (Nsync Target) or any FTP server for safe keeping as long as you have appropriate access right on that target.

If the files on your Thecus IP storage are lost for any reason, you can restore those files from the target Thecus IP storage. To backup files regularly, you can set up a

scheduled task to run only once, daily, weekly, or monthly. You can also limit the bandwidth of your Nsync tasks, so other users on the network can share the bandwidth equally.

Under the **Backup** menu, click **Nsync** and the **Nsync** window appears.

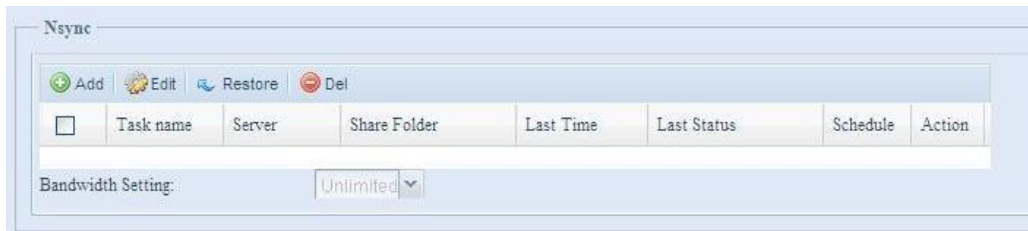

Below is a description of each field:

Nsync	
Item	Description
Add	Click to add a Nsync task
Edit	Click to Edit an Nsync task.
Restore	Restore share folder from an Nsync target.
Del	Click to delete an Nsync task. Backup files on Nsync target is also deleted.
Task name	The name of your Nsync task.
Server	The IP address of your target server
Share folder	The share folder you would want to backup.
Last Time	The time when the last Nsync task was executed.
Last Status	The status of your last Nsync task.
Schedule	Schedule backup of your share folders.
Action	Administrator can run or stop an Nsync task by pressing the action button.
Bandwidth Setting	Bandwidth control on Nsync tasks.

Add Nsync Task

From the **Nsync** screen, click **Add** to display the **Add Nsync Task** screen.

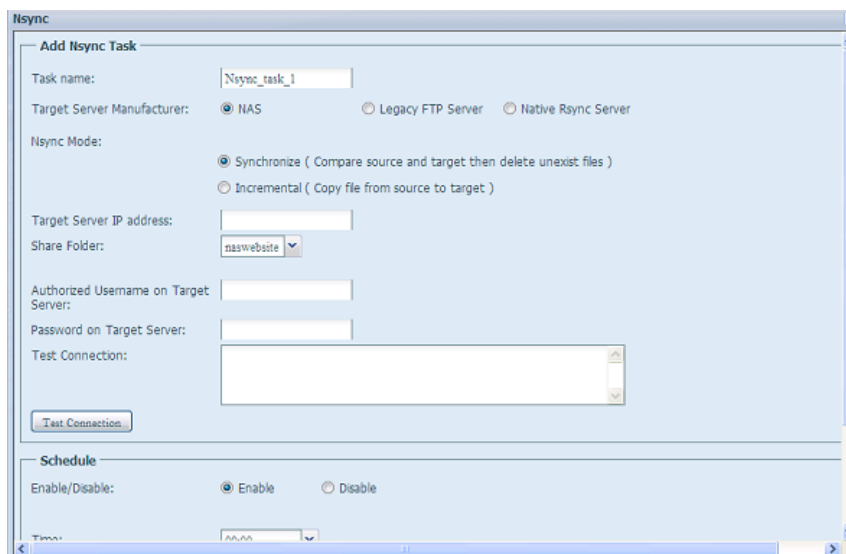

Add Nsync Task	
Item	Description
Task Name	The name of your Nsync task.
Target Server	Select replication to method, it has 3 options can choose from.

Manufacturer	NAS: To other Thecus IP storage with security tunnel build up. Legacy FTP: To the 3 rd party FTP server or Thecus IP storage while it has acted as FTP server. Native Rsync Server: Using rsync to replicate data to other Thecus IP storage
Nsync Mode	Synchronize mode or Incremental mode .
Target Server IP Address	The IP address of your target server.
Source Folder	The share folder you want to backup.
Authorized Username on Target Server	The account name on the target server.
Password on Target Server	The password for the username on the target server.
Test Connection	Click to check the connection to the Target Server.
Schedule	Enable or Disable schedule backup of your share folders.
Time	The time when the Nsync task will run.
Type	Select whether to run the Nsync task daily, weekly, or monthly. Daily: input the time of day to execute Nsync task. Weekly: input which day of the week to execute the task. Monthly: decide which day of the month to execute the task.
Add	Press Add to submit your settings.

NOTE

Before starting an Nsync Task, make sure the target server's Nsync Server (or FTP Server) is enabled.

NOTE

Using "Native Rsync Server" to backup data to other Thecus NAS devices needs to enable target server and setup a valid username and password to grant access permission.

Setting up an Nsync Target on an Thecus IP storage Nsync Device

On the Nsync target server, the administrator of that server has to set up a user account with a folder named "nsync" and grant write access.

1. On the Nsync server, add a user for Nsync source (ex. nsyncsource1). For instructions on how to add a user on the Thecus IP storage, see **Chapter 4: User and Groups Authentication > Local User Configuration > Add Users**.
2. On the Nsync server, grant that user (ex. nsyncsource1) write access to the **nsync** folder. For instructions on how to set up a folder's ACL, see **Chapter 4: Storage Management > Share Folder > Folder Access Control List (ACL)**.
3. Once this is done, the target server will start accepting Nsync tasks from server using that ID and password.

Setting Up an Nsync Target on another Device other than Thecus IP storage

If you selected "Legacy FTP Server" when setting up your Nsync task, the Thecus IP storage will use the FTP protocol to back up the share folder. On the external storage device, make sure there is a folder named "nsync", and the Auth ID has writable permission in that folder.

Designating Thecus IP storage as an Nsync Target

The Thecus IP storage can act as an Nsync server, enabling another Nsync-equipped Thecus NAS at a remote location backup their files to this Thecus IP storage. From the **System Network** menu, choose the **Nsync Target** item, and the **Nsync Target Server** screen appears.

Nsync Target Server Setting	
Item	Description
Nsync Target Server	Enable or Disable Nsync Target support.

NOTE

To enable Nsync task to go thru firewall, you have to open port TCP/1194 on your firewall in both directions.

Nsync Target (Does not apply to the 3X series)

From the **Backup** menu, choose the **Nsync Target** item, and the **Nsync Setting** screen appears. Enable or Disable your Nsync Target Server. Press **Apply** to confirm your settings.

If the Thecus Nsync feature has chose to use Rsync to replicate data between two systems. For the target side to allow source cross data, the Rsync target server needs to assign a username and password for authentication.

Once **Nsync Target** has been enabled, the other Thecus NAS product is able to operate remote replication to this NAS system.

The screenshot shows two configuration panels. The top panel, titled 'Nsync Setting', contains the label 'Nsync Target Server:' followed by two radio buttons: 'Enable' (which is selected) and 'Disable'. The bottom panel, titled 'Rsync Setting', contains the label 'Rsync Target Server:' followed by two radio buttons: 'Enable' and 'Disable' (which is selected). Below these are two text input fields labeled 'Username:' and 'Password:'. At the bottom of the form is an 'Apply' button.

Dual DOM (Not available on N3200XXX/N0503/N4200Eco/N7700/N8800 NAS)

The unique Dual DOM feature can now perform "Auto Repair". The Thecus NAS will backup up to five versions of the system configuration either by the default timing of 1:00am every day automatically or as scheduled by the user.

This unique "Auto Repair" will be triggered if the primary DOM has a booting issue. In this instance, the 2nd DOM will take over the boot function. Then, the system will automatically load the most recent system configuration backup image to repair the primary DOM.

Dual DOM Schedule Backup

Enable/Disable Dual DOM schedule backup

Auto

Daily

Weekly

Monthly

Status:

Dual DOM Backup Status

Task Name	Date	Firmware
backup_0000000	2002/01/01 01:00	5.00.00.12.dev

Rsync Target Server

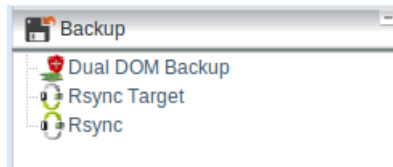

When it comes to backing up your data, it's very important to have flexibility. Rsync Backup provides you with many options, including local or remote backup, backup scheduling, different synchronization settings, and password protection. Being based on the Linux operating system, it is also much more stable and experiences much less frequent data loss during transfer than other remote backup systems.

-For this tutorial you will need to use Rsync Target (Step 1) and Rsync (Step 2+3) under Backup.

Step 1 – Enabling Rsync on your target (backup) NAS

- Log in to your target (backup) NAS through the UI in your web browser
- Go to Rsync Target under Backup in the menu of the UI

Home > Backup > Rsync Target

Rsync Setting

Rsync Target Server : Enable Disable

Username:

Password:

1. Enable **Rsync Target Server**
2. Add a **username** and **password** (they can be different than your NAS's username and password)
3. Select **Apply**

*Now Rsync is turned on on your NAS, which means it can be used as a target for Rsync backup, in other words, only the backup NAS needs to be activated in this way.

Rsync

Step 2 – Setting up your backup task and schedule on your source NAS

- Log in to your other NAS (your source NAS) through the UI in your web browser
- Go to **Rsync Backup** under **Backup** in the menu of the UI
- From the **Rsync Schedule Backup** task list, choose **Add**

The screenshot shows the 'Rsync Schedule Backup' configuration page. At the top, there are three buttons: 'Add' (highlighted with a red box), 'Modify', and 'Delete'. Below this is the main configuration form with the following fields and callouts:

- 1** Task Name: Task_1 (with a note: (Allow 0-9, a~z, A~Z, _))
- 2** Backup Mode: Synchronize(Compare source and target then delete unexist files) (selected), Incremental(Copy file from source to target)
- 3** Source Folder: A list box containing folders like rsync backup, usbcopy, naswebsite, samba, _P2P_Download_, shared, iTunes_music, music, photos, movies. A note says: (Please click Shift or Ctrl button, and click mouse left button to select multiple folder or remove selected folder)
- 4, 5** Target Server: Port: 172.16.64.144
- 6** Destination path / Subfolder: public / multimedia. Notes: Please fill in the destination path to select a specific backup folder on the target side. You may leave it empty to have the files automatically backup to the existing folder on the target side. (Please make sure there are existing folders with the same name on both target and client side.)
- 7** Username: admin1
- 8** Password: *****
- 9** Log Folder: rsync backup
- 10** Test Connection: A button labeled 'Test Connection'.

Below the configuration form is the 'Schedule' section:

- 11** Enable/Disable: Enabled (selected), Disabled
- 12** Time: 02:00
- 13** Type: Daily, Weekly (selected), Monthly
- 14** Sunday: A dropdown menu currently showing 'Sunday'.

At the bottom of the form are two buttons: 'Apply' (highlighted with a red box) and 'Back'.



-Fill out all the necessary details and choose your parameters

- 1. Name your task** - This is how it will appear in the task list.
- 2. Choose your backup mode** -
 - Synchronization mode** - Makes your source match your target completely; deleting and adding files on your target as they are deleted and added on your source.
 - Incremental Mode** - Makes your source match your target and keep all old files; adding files on your target as they are added on your source, but NOT deleting files on your target as they are deleted on your source.
- 3. Choose your source folder(s)** - These are the folders on your source NAS that you wish to backup.

4. **Input your target's IP address and port number** - This is the NAS which you are going to use as a backup, port number is optional.
5. **Input your destination folder and create a backup folder** – Your destination path is the name of an existing folder on your NAS where you wish to backup your .
6. **Input your username and password** - This is the username and password you set in "Rsync Target" on your target NAS.
7. **Choose a folder to keep your backup log in** - This lists all the changes during each backup in a single file.
8. **Test your connection** - If there is an error, review the instructions and make sure you didn't miss a step.
9. **Enable or disable regular automatic backups** - To run backups manually choose "disable", your settings will still be saved.
10. **Apply** - This saves your backup task in the Rsync Schedule Backup task list, running your automatic backup tasks in the background as well as allowing you to easily edit or manually run your tasks at any time.

Step 3 – Manually edit or run your backup tasks

-After selecting "apply", you will be brought back to the Rsync Schedule Backup task list.

 Add |  Modify |  Delete

Rsync Schedule Backup							
	Task Name	Source Folder	Schedule	Target Server/Path	Last Time	Last Status	Action
S <input type="checkbox"/>	Task_1	[music], [photos], [movies]	Sunday 02:00 (Disabled)	172.16.64.144/public/multimedia	2010/09/15 15:53	in progress	<input type="checkbox"/>
S <input type="checkbox"/>	Task_2	[spreadsheets]	Sunday 02:00 (Enabled)	172.16.64.147/public/spreadsheets			

-Simply click the arrow to start the task, whether the scheduler is enabled or disabled, and click the box to cancel the ongoing task.

Thecus Backup Utility

The Thecus Backup Utility is on your Installation CD. When you click on the CD, the Backup Utility will be installed under **Program Groups > Thecus > Thecus Backup Utility**. If it is not installed, you can copy the file (**Thecus Backup Utility.exe**) to a convenient location on your hard disk and double click to execute it.



NOTE

If you can not find Thecus Backup Utility on your CD, please download it from the Thecus website (<http://www.thecus.com>).

When you execute this utility for the first time, it will ask you whether to create a DB file. Click **Yes**.

1. Click **Add** to create a Backup task. The **Add New Task** dialog box appears.

Add New Task	
Item	Description
Task	Specifies a name for the current task.
Source	Click to specify the source folder/file location.
Incremental	Click to specify whether the backup will be incremental. If unchecked, the backup will be a full backup.
Destination	Click to specify the destination folder/file location.
Excluded extensions	Files with these file name extensions will be skipped and not back up to the destination.
Comments	If you wish, enter comments here for your records.

2. To schedule the task to run at regular intervals, click on the **Schedule** icon for that task. You can schedule the task to run **Monthly** or **Weekly**.
3. To check the log for that task, click on the **Log** icon for that task.

NOTE

Thecus Backup Utility also supports MAC OS X. Just copy the Thecus Backup Utility.dmg to your MAC OS X machine and double click to execute it.

Windows XP Data Backup

If you use Windows XP Professional, you can also use the Windows Backup Utility (Ntbackup.exe) to backup your files.

If you use Windows XP Home Edition, follow these steps to install the utility:

1. Insert the Windows XP CD into a drive and double-click the **CD** icon in **My Computer**.
2. When the Welcome to Microsoft Windows XP screen appears, click **Perform Additional Tasks**.
3. Click **Browse this CD**.
4. In Windows Explorer, navigate to **ValueAdd > Msft > Ntbackup**.
5. Double-click **Ntbackup.msi** to install the backup utility.

Once installed, you can use the Windows Backup Utility by following the steps below:

1. Click **Start**, and point to **All Programs > Accessories > System Tools > Backup** to start the wizard.
2. Click **Next** to skip past the opening page. Choose **Backup files and settings** from the second page, and then click **Next**.
3. Select which option you want to back up.
4. Click **Next** and in the Backup Type, Destination, and Name page, specify a back up location using the **Browse** button.
5. Find and select the drive that specifies your Thecus IP storage as your backup destination and click **Next**.
6. Click **Next** to display the wizard's final page and click **Finish** to start backing up.

Apple OS X Backup Utilities

Mac OS X does not include any backup software. However, there are a number of backup solutions available for the Mac OS X, including: [iBackup](#), [Psyncx](#), [iMSafe](#), [Rsyncx](#), [Folder Synchronizer X](#), [Tri-BACKUP](#), [Impression](#), [Intego Personal Backup](#), [SilverKeeper](#), and Apple's dotMac Backup utility to name just a few. To find even more freeware and shareware backup utilities to choose from, go to [VersionTracker](#) or [MacUpdate](#) and search on "backup".

External Devices

Thecus IP storage support printer serving and UPS backup power supplies. The integrated print server allows you to share a single USB printer with all users on the network. The UPS backup power supply provides continuous power during power outages.



Printer Information

From the **External Device** menu, choose the **Printer** item, and the **Printer Information** screen will appear. This screen provides the following information about the USB printer connected to the USB port.

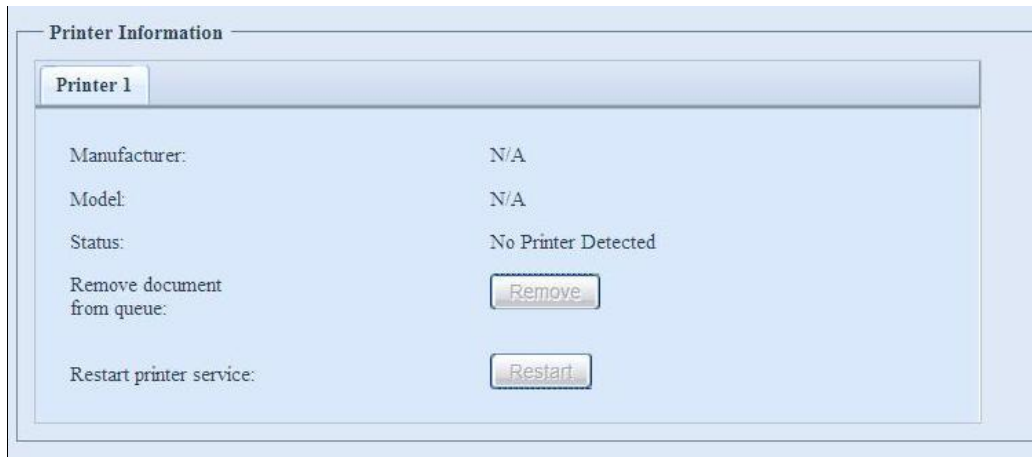

Printer Information	
Item	Description
Manufacturer	Displays the name of the USB printer manufacturer.
Model	Displays the model of the USB printer.
Status	Displays the status of the USB printer.
Remove document from Queue	Click to remove all documents from printer queue.
Restart Printer service	Click to restart printer service.

If a corrupt print job is sent to a printer, printing may suddenly fail. If your print jobs seem to be locked up, pressing the **Remove All Documents** button to clear the print queue may resolve the issue.

You can configure Thecus IP storage to act as a printer server, letting all PCs connected to the network utilize the same printer.

Windows XP SP2

To set up the Printer Server in Windows XP SP2, follow the steps below:

1. Connect the USB printer to one of the USB ports (preferably the rear USB ports; front USB ports can be used for external HDD enclosures).
2. Go to **Start > Printers and Faxes**.
3. Click on **File > Add Printer**.
4. The **Add Printer Wizard** appears on your screen. Click **Next**.
5. Select the **"A network printer, or a printer attached to another computer"** option.
6. Select **"Connect to a printer on the Internet or on a home or office network"**, and enter **"http://Thecus IP storage IP_ADDRESS:631/printers/usb-printer"** into the URL field.
7. Your Windows system will ask you to install drivers for your printer. Select correct driver for your printer.

8. Your Windows system will ask you if you want to set this printer as “Default Printer”. Select **Yes** and all your print jobs will be submitted to this printer by default. Click **Next**.
9. Click **Finish**.

NOTE

- Not all USB printers are supported. Please check Thecus website for a list of supported printers.
- Note that if a multi-function (all-in-one) printer is attached to the Thecus IP Storage, usually only the printing and fax functions will work. Other features, such as scanning, will probably not function.

Windows Vista

To set up the Printer Server in Windows Vista, follow the steps below:

1. Open **Printer Folder** from the **Control Panel**.

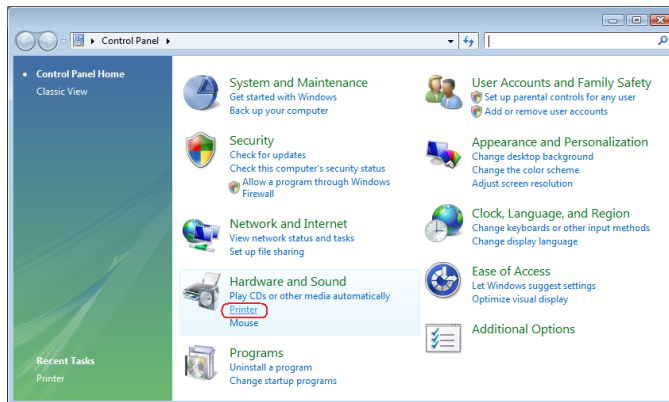

2. Click the right mouse button in anywhere on the **Printers** folder and then select **Add Printer**.

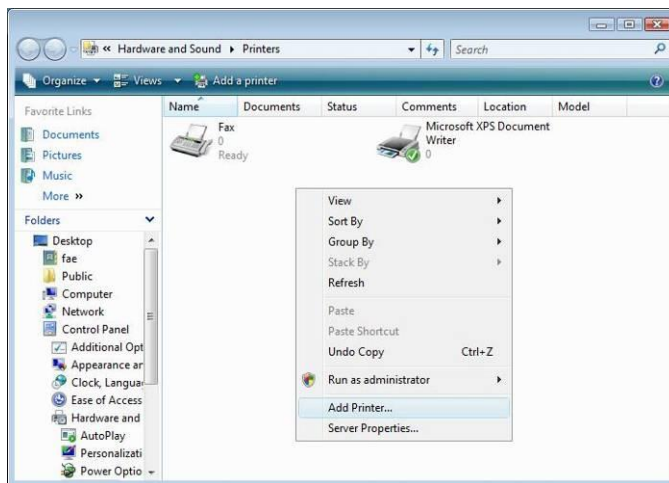

3. Select **Add a network, wireless or Bluetooth printer**.

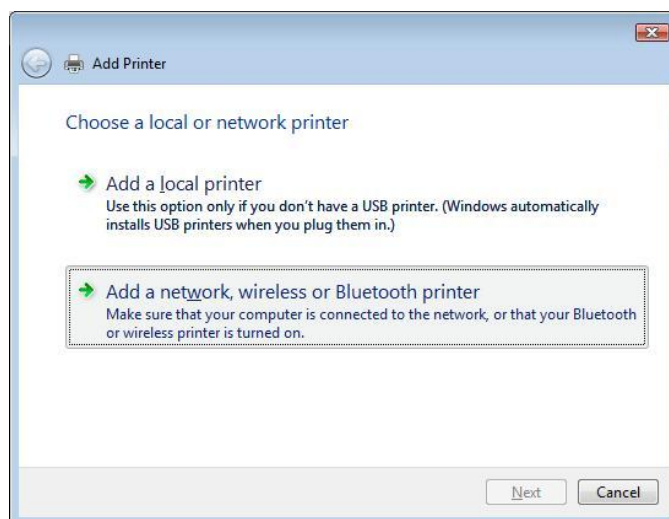

4. Select **The printer that I want isn't listed**.

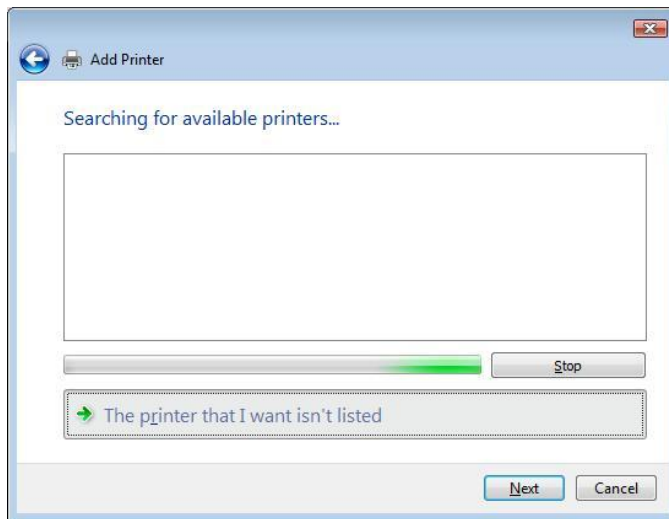

You can press **The printer that I want isn't listed** to go into next page without waiting for **Searching for available printers** to finish.

5. Click **Select a shared printer by name**.

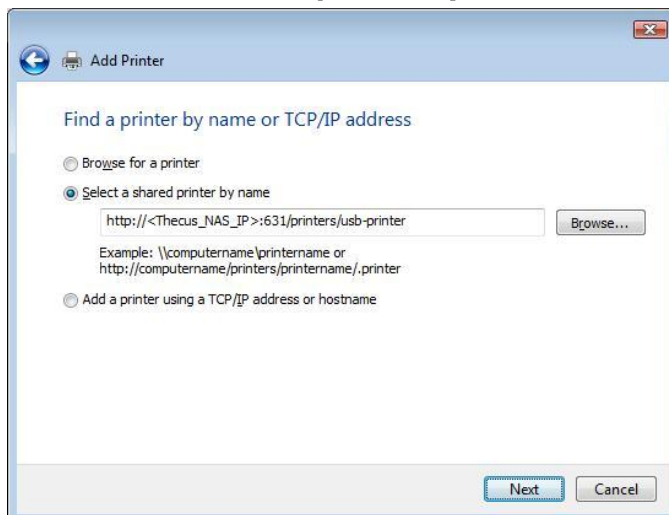

Type `http://<Thecus_NAS>:631/printers/usb-printer` in the box, where `<Thecus_NAS_IP>` is the IP address of Thecus IP storage. Click **Next**.

6. Select or install a printer and then press **OK**.

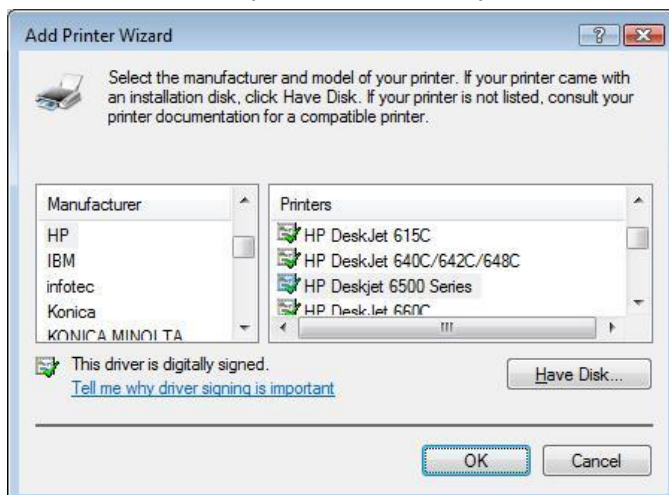

If your printer model is not listed, please contact your printer manufacturer for help.

7. Windows will attempt to connect to the printer.

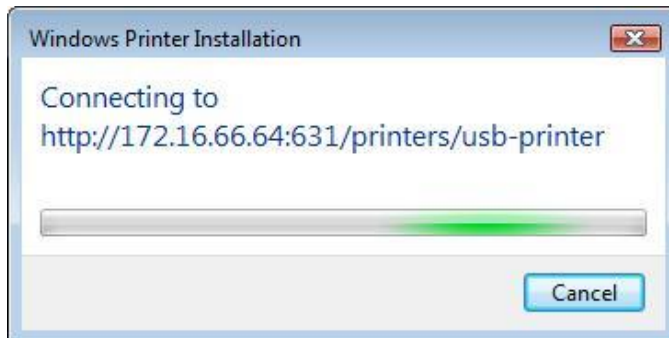

8. You can choose to set this printer as the default printer by checking the **Set as the default printer** box. Click **Next** to continue.

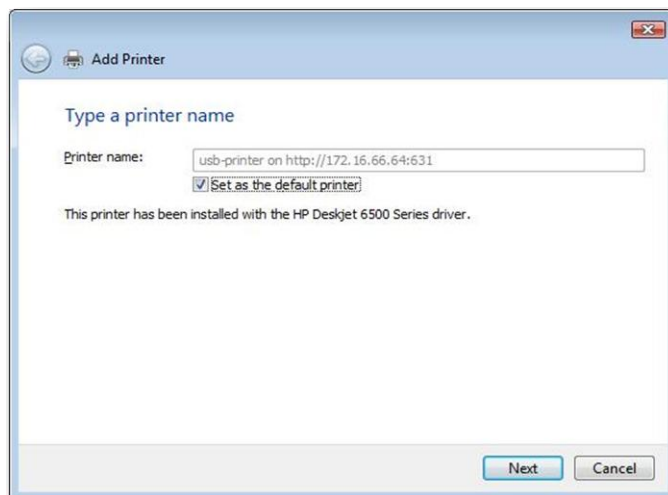

9. Done! Click **Finish**.

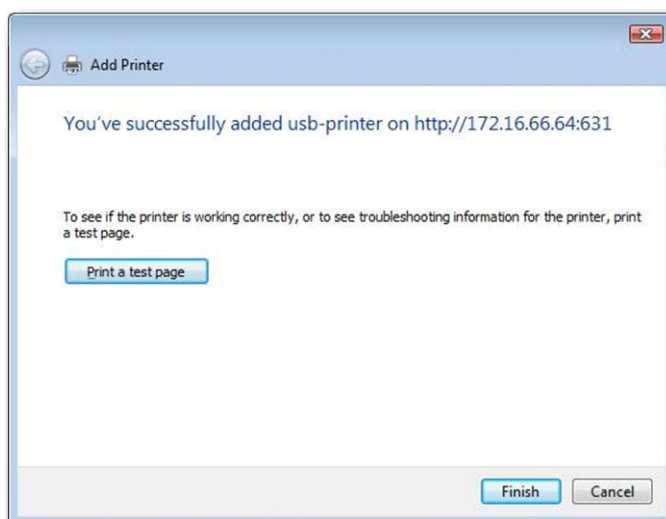

UPS Setting

The Thecus IP storage can also support various uninterruptible power supply unit via either "Serial" or "USB" interface (depend on model) to provide extra data security and accessibility in the case of a power failure.

From the **Status** menu, choose the **UPS** item and the **UPS Setting** screen appears. Make any changes you wish, and press **Apply** to confirm changes.

See the following table for a detailed description of each item.

UPS Setting	
Item	Description
UPS Monitoring	Enable or disable UPS monitoring.
Manufacturer	Choose the UPS manufacturer from the dropdowns.
Model	Choose the UPS model number from the dropdowns.
Battery Status	Current status of the UPS battery
Power	Current status of the power being supplied to the UPS
Seconds between power failure and first notification	Delay between power failure and first notification in seconds.
Seconds between subsequent power failure notifications	Delay between subsequent notifications in seconds.
Shutdown the system when the battery charge is less than	Amount of UPS battery remaining before system should auto-shutdown.
Apply	Press Apply to save your changes.

Chapter 5: Using Thecus IP Storage

Overview

Once the Thecus IP storage is setup and operating, users on the network may manage all varieties of digital music, photos, or files by simply using their web browsers. To manage your personal files or access public files on the Thecus IP storage, just enter its IP address into your browser (default IP address is <http://192.168.1.100>), and you will be taken to the **Thecus IP storage Login** page.

NOTE

Before proceeding, make sure that WebDisk Support or Secure WebDisk Support is enabled in the Service Support screen in the system's **Network** menu. See Service Support in Chapter 4: Network Service >HTTP/Web Disk.

Login Page

To login to the system, enter your user name and password, and select Web Disk or Photo server then click **Login** to log into the system. You will be taken to the **selected** interface.



Using the Web Disk (Does not apply to the 3X series' Web Disk)

Thecus IP storage provide a Web Disk function that allows you to access the system over the Internet from any browser.

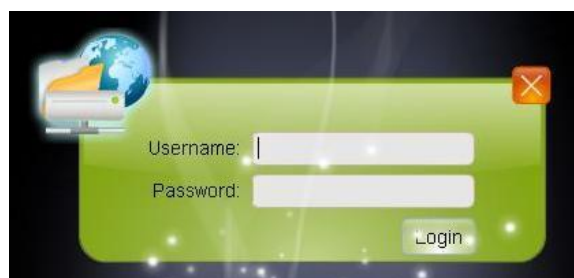

1. In the Login page, type in the User ID and password that were previously set for you in the Accounts menu. See **Chapter 4: User and Group Authentication > Local User Configuration**.
2. The Web Disk page appears showing folders currently available to you, this is controlled via the **Access Control List (ACL)**.
3. Click on a folder name to enter the folder.
4. The folder's page appears displaying files and folders. Click on a file to download the file.
5. Buttons on the folder page allow you to create new folders, upload files, and delete files in the folder.
6. To create a new folder within the current folder, press the New Folder button. When the screen appears enter a name for the folder. Press OK to create the folder.
7. To upload a file from your computer to the current folder, press the New File (upload) button. When the screen appears, press **Browse** and locate the file to upload. Press **OK** and the file will be uploaded to the current folder.
8. To delete a file or folder, select the file or folder's check box. Press Delete button. You can also click the Select All button to select all files and folders in this folder.

To access folders with access control, you must first login with a local user account.

For more information on how to setup user rights to the folders, please check **Chapter 4: Storage Management > Share Folder > Folder Access Control List (ACL)**.

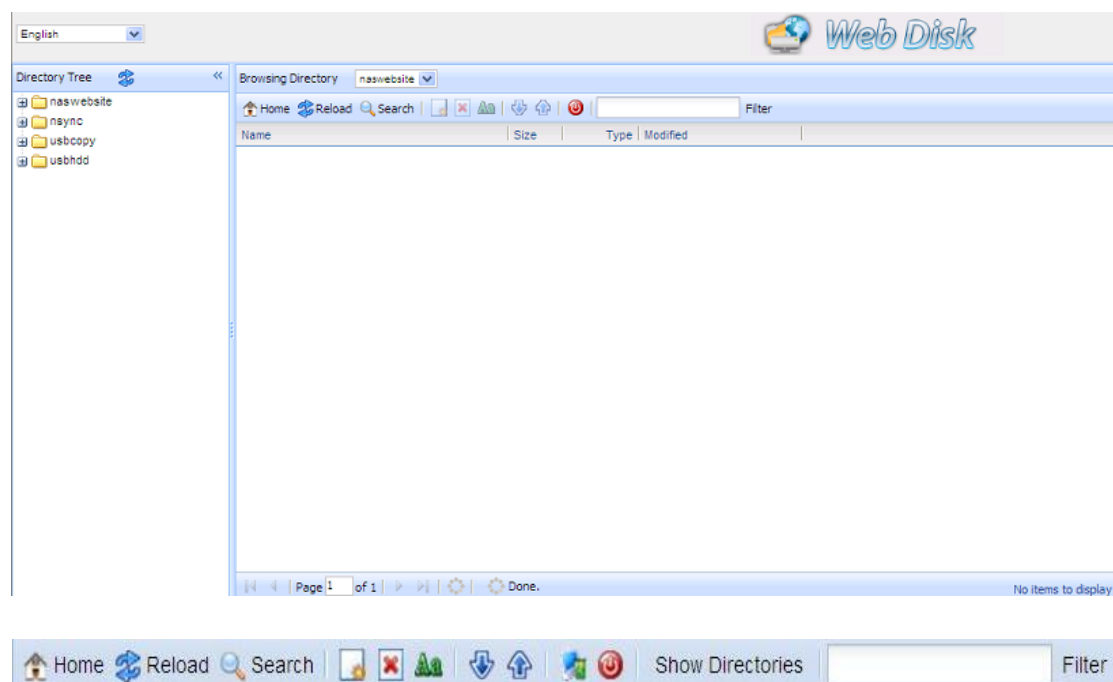

Folder Page Button	
Button	Description
Directory Tree	List all directory trees per login user's privilege.
Browsing Directory	Browsing selected directory of its folders and files.
Home	Go back to the web disk directory layer.
Reload	Re-load the current list.
Search	Search files in the current web disk directory. (Must input the complete file name.)
(new file/Directory)	Creates a new folder or directory.
(delete)	Deletes selected files or folders.
(Rename)	Rename a directory or file.
(download)	Download a file to current folder of your computer.
(upload)	Upload file from your computer to current web disk folder.
(Admin)	Change password and confirm new password.
(logout)	To logout of the web disk interface.
Show Directories	Show the files and folders in the directory.
Filter	Search files in the directory. (You can only input some word string.)
Name	Displays the names of folders and files.
Size	Shows the size of folders and files.
Type	Displays the type of folders and files.
Modified	Shows the time of most recent modification of folders and files.
owner	Owner of the file.

There is also the way by using right click button to bring up context windows as short cut to operate what you needed.

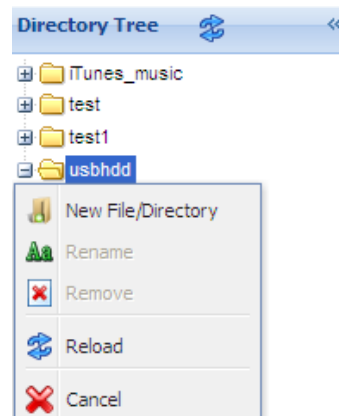
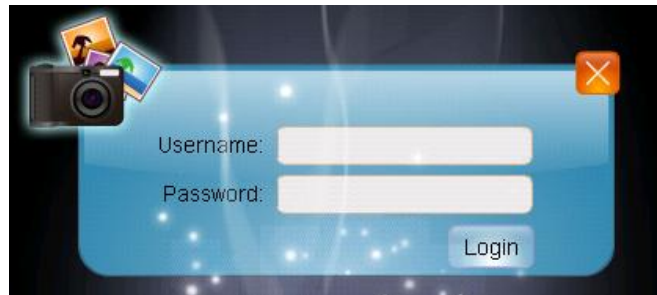

Photo Server (Does not apply to the 3X series' photo server)

Using the Photo Server, users can view and share photos, and even create their own albums right on the Thecus IP storage.

You will see your own photo gallery and all public photo albums on the network.

To manage any picture files, you must first select the item by clicking the box then entering your user name and password to log in to the photo server.



Windows XP Publishing Wizard

There are many ways for a local user to upload pictures into their photo album. Users of Windows XP can upload their pictures using the Windows XP Publishing Wizard.

1. Click on the **XP Publishing Wizard** icon on top right corner. 
2. The **XP Web Publishing Wizard Client** screen appears. Click on the link to install the Publishing Wizard.

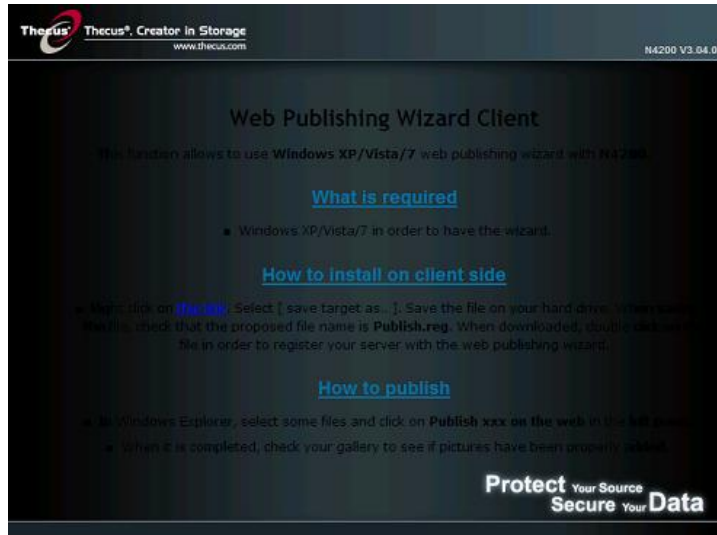

3. Windows XP will ask whether you want to run or save this file. Click **Save** to save the register file.

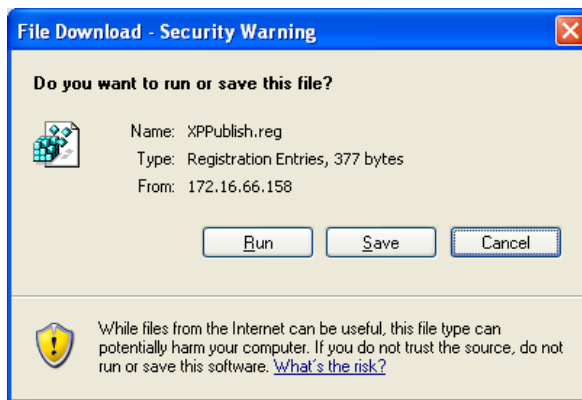

4. Once the register file is installed, use the Windows file manager to browse the folder that contains the picture you want to publish. On the left pane, there will be an icon labeled "**Publish this folder to the Web**".

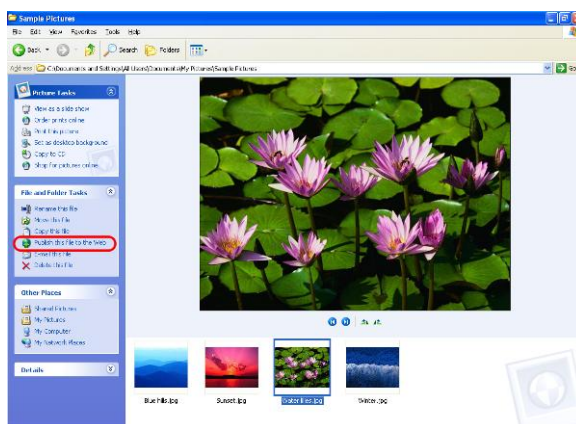

5. Click on this icon and **Web Publishing Wizard** will start.

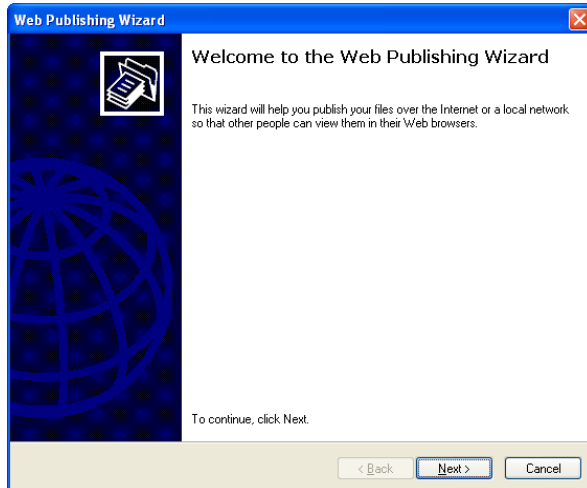

6. Select the pictures you want to publish to the Photo Web Server by placing a check mark on the top left hand corner of the picture. Click **Next**.



7. Your PC will start to connect to the Photo Web Server.
8. Select **Thecus IP storage Photo Gallery Wizard** to publish your pictures to Thecus IP storage.

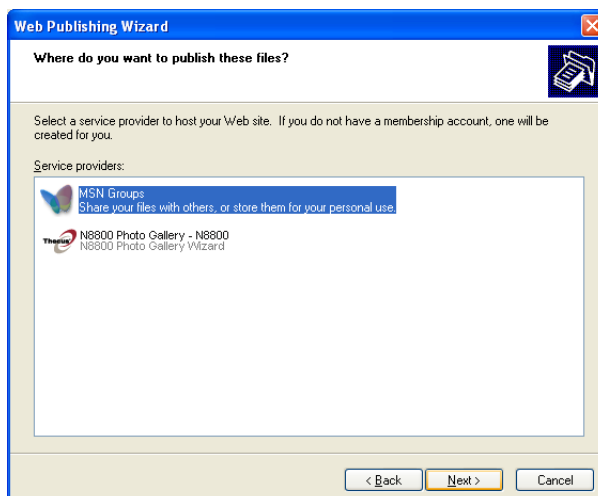

9. Login into Thecus IP storage with your local user name and password.

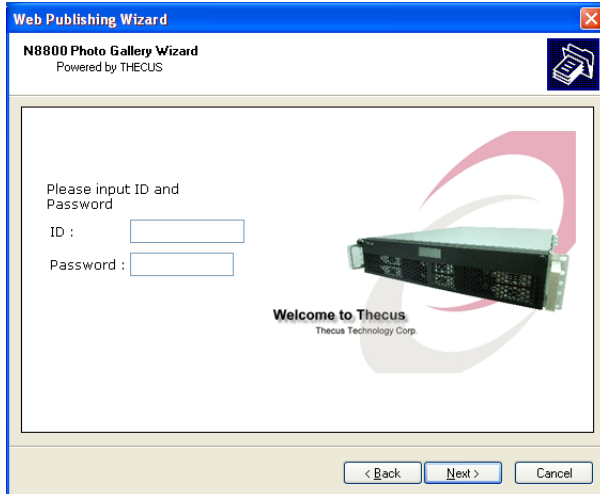

10. Create your album by entering an album name and clicking on the **Create Album** button.



11. Select the album you want to upload your pictures to.
12. Confirm the target album.

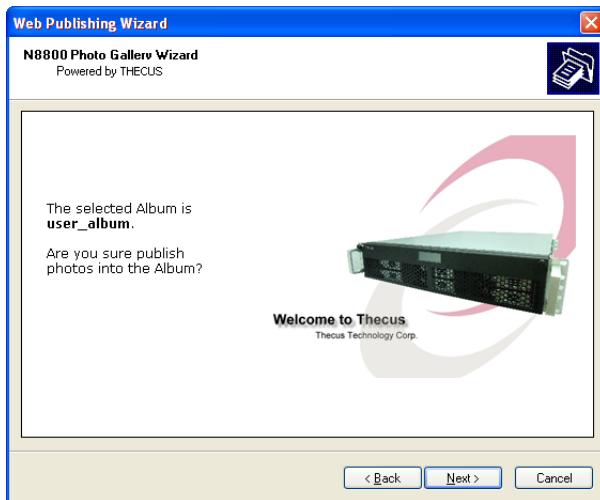

13. Windows will show you that the picture upload is in progress.

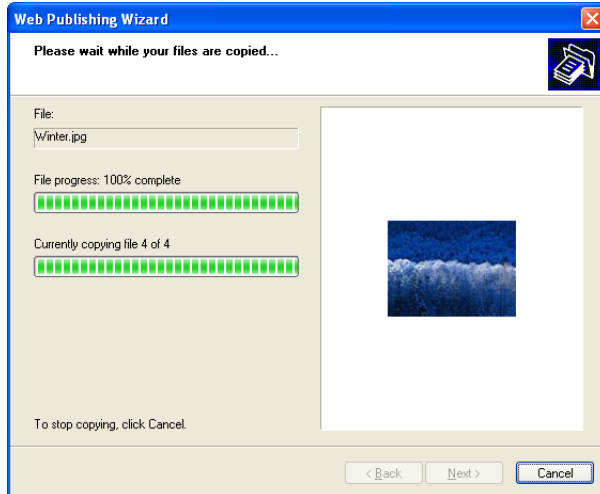

14. When the upload is finished, the Wizard will ask you whether if you want to go to the website. Click **Finish** to go to your Photo Web Server.

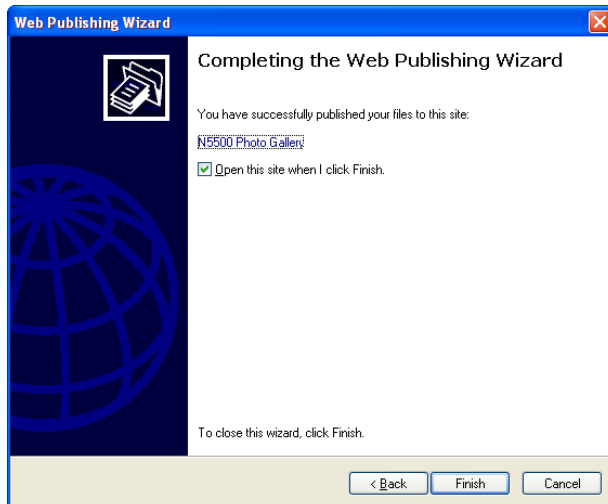

15. Click on the user's icon to go to that user's album.



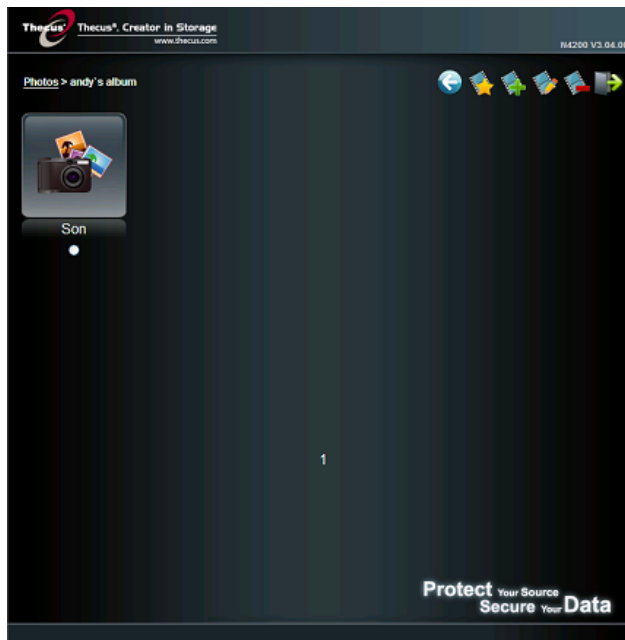

16. You will see the user's album list. Click on **Album**.



17. Finished! You will see the pictures just selected in the album.



Managing Albums and Photos

Icon	Function	Description
	Make Cover	Make selected photo your cover picture.
	Back	Return to the previous screen.



Add

Add a new album or photos.



Modify

Edit the name and description of the selected album or photo. Each name is limited to 20 characters and each description is limited to 255 characters.



Delete

Delete the selected albums or photos.

NOTE

- Only logged in users will see these icons.
- To prevent system errors, Thecus IP storage sets the following limitations on photo files:
 - Each file upload is limited to a size of 8MB. Files exceeding 8MB will NOT be uploaded and no error message will appear.
 - Only these photo file types will be uploaded: *.jpg, *.gif, *.bmp, *.png, *.pcx, *.psd, *.bmp.
 - If duplicate file names exist during upload process, system will add a number in front of the original file name (abc → 1abc).

Creating Albums

To create a photo album, follow the steps below:

1. Click the **Add** button to create a new album.
2. Enter a name for the album, and enter a description if you wish. Then, click on the **Create Album** button.

Password Protecting Albums

If you would like to put a password on a particular album, follow these steps:

1. Select the album to be protected, click on the **Edit** button, and the **Album Edit** screen will appear.
2. The owner of the album can enter an album password to protect the album, so that only people with the correct password can view the album.

Uploading Pictures to Albums

Uploading pictures to albums using the Web User Interface is easy:

1. When the album is created, click the album icon to enter the album. Initially the album is empty.
2. Click the **Add** button to upload pictures into the album. The **Upload Photos** screen will appear. Users can select and upload up to 8 pictures at a time.
3. Once the picture is uploaded, you can view it in the album. The owner of the album can delete or modify the pictures with the **Delete** or **Modify** buttons on the top right hand corner

EXIF Information

While viewing pictures, you can also have Thecus IP storage display the EXIF information for each photo.



Simply click the **EXIF** button to display EXIF information. To hide this information, click the **EXIF** button again.

Slide Shows

Slide shows are a great way to enjoy pictures stored on your Thecus IP storage.

You can click on the **Start Slide Show** icon on the top right hand corner to start the slide show.



To stop the slide show, click on the **Stop Slide Show** icon on the top right hand corner.

Mapping a Client PC to the Thecus IP Storage

You can map share folders on Thecus IP storage so that you can access them as if they were drives on your computer. You can connect to the shared network folders on Thecus IP storage as follows:

Windows

1. Go to the **My Computer** folder in Windows.
2. In the menu bar, select **Tools** and then **Map Network Drive...**
3. The **Map Network Drive** window appears.
4. Assign a drive letter for the share folder.
5. Click the **Browse** button to find the folder over your network. Alternatively, you may enter the folder name you wish to connect to or enter its IP address. (i.e. \\192.168.1.100\share)
6. Click **Finish**. When the **Connect As...** window appears, enter your user name and password.
7. Click **OK**. The share folder appears as the drive you assigned. You can now access this folder as though it were a drive on your computer.

Apple OS X

On an Apple computer, you can connect to shared computers and servers using a network address.

1. Choose **Go > Connect to Server...**
2. Enter the network address for the server in the Server Address text box.
When connecting using SMB/CIFS protocol, type:
smb://192.168.1.100/Folder1
When connecting using AFP protocol, type:
afp://192.168.1.100/Folder1
Click **Connect**.
3. When MAC OS X is trying to connect Thecus IP storage, it will ask for a User Name and Password which has access to the folder.
4. When MAC OS X has connected to Thecus IP storage successfully, an icon representing the folder will appear on the MAC OS X desktop. You can access the folder by double clicking on the icon.

Mapping Thecus IP storage as an iSCSI Drive

With Thecus IP storage, you are able to map it as an iSCSI drive. With iSCSI, you can remotely access Thecus IP storage at great speeds, as if it were installed as a local drive in your computer.

To do this, simply follow the steps below:

Windows 2000/XP

1. First, download the iSCSI Initiator from the Microsoft website (<http://www.microsoft.com>). You can find this software by entering iSCSI Initiator into the search box on their homepage.
2. Once the download is complete, install the iSCSI Initiator by double-clicking the EXE file. You may be presented with the following security warning. Click **Run** to continue.

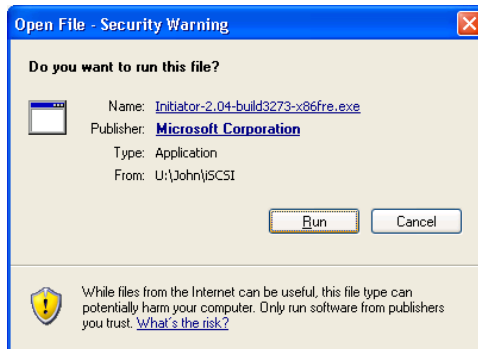

3. You will now install the iSCSI Initiator using the Setup Wizard. Click **Next** to continue.

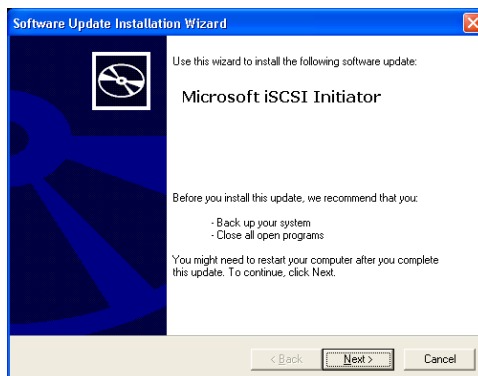

4. Leave the default selections and click **Next**.

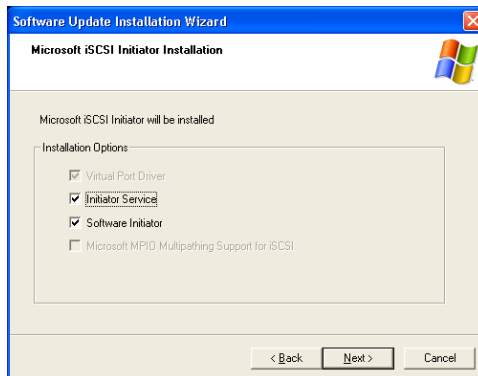

5. Read the license agreement. To continue with the installation, click **I Agree** and then click **Next**.

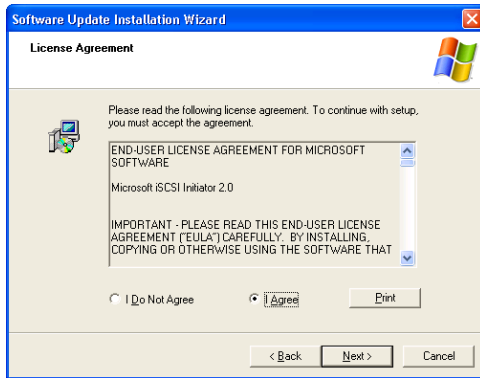

- The iSCSI Initiator will now install automatically. Click **Finish** once completed.

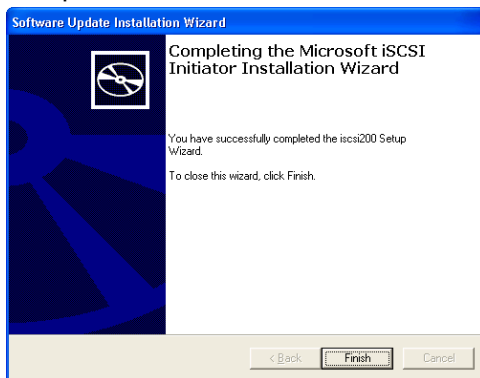

- Start the iSCSI Initiator by double-clicking its icon on the desktop. The iSCSI Initiator properties window will appear.



- Select the **Discovery** tab. Under **Target Portals**, click **Add**.

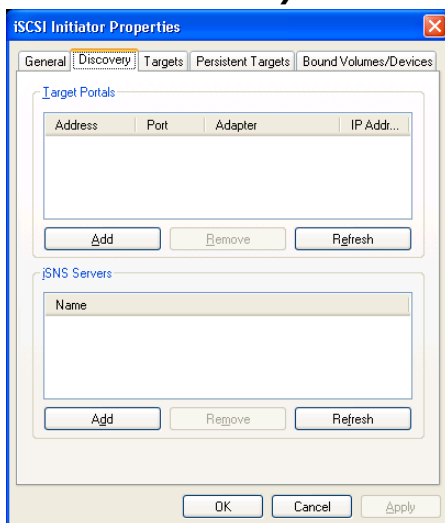

- Enter the IP address of Thecus IP storage. Click **OK**.

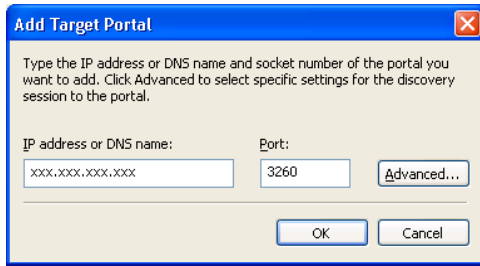

10. On the **iSCSI Initiator Properties** window, select the **Targets** tab. With the iSCSI target highlighted, click **Log On**. The **Log On to Target** dialogue will appear.

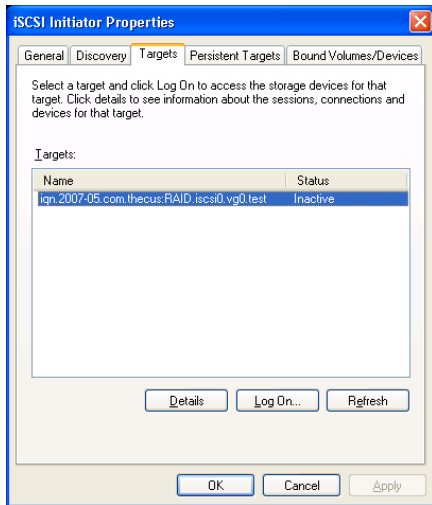

11. If you have not enabled CHAP, click **OK** to continue.

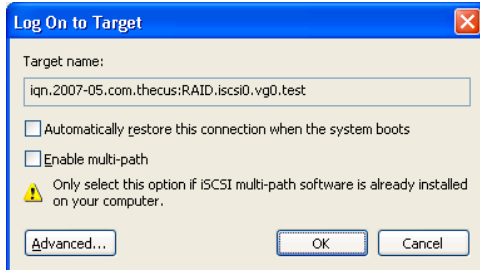

If you have enabled CHAP, click **Advanced**. Under Advanced Settings, check the **CHAP login information** checkbox and enter your username and password. Click **OK**.

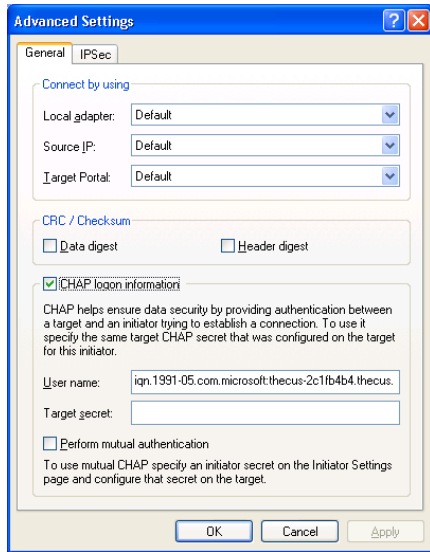

12. Right click **My Computer** on the desktop and select **Manage**.

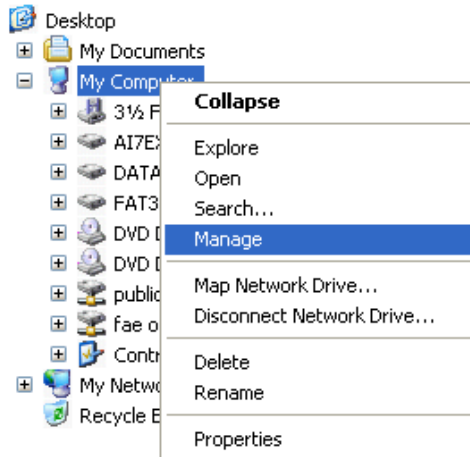

13. Click on Disk Management and you will see a new hard disk listed.

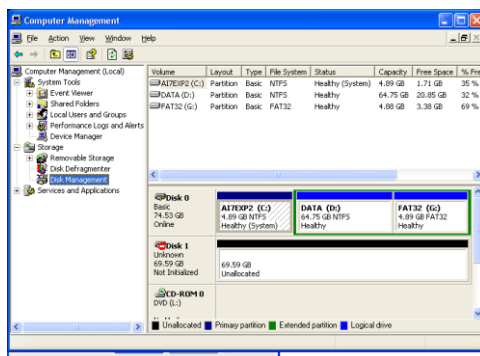

14. Initialize the new hard disk and you will then be able to use the iSCSI target as a local drive.

Windows Vista

Because Windows Vista has the Microsoft iSCSI Initiator pre-installed, you will not have to install this piece of software. Instead, start the iSCSI Initiator and follow steps 8-14 to map the Thecus IP storage as an iSCSI drive.

Chapter 6: Tips and Tricks

USB and eSATA Storage Expansion

The Thecus IP storage supports external USB hard disks through its USB ports. Once a USB hard disk has successfully mounted, the entire volume will be linked automatically to the default USB HDD folder. The Thecus IP storage supports USB external storage devices. All file names on the USB disk volume are case sensitive.

The Thecus IP storage also supports eSATA hard disks with its eSATA port.

Before attaching an eSATA or USB disk drive to Thecus IP storage, you have to partition and format it on a desktop computer or a notebook first. The attached device will be located at `\\192.168.1.100\usbhdd\sd(x)1` where `192.168.1.100` means the IP address of Thecus IP storage and `sd(x)1` stands for the first partition on the eSATA or USB disk drive.

Adding a Spare Disk

With a RAID 1, RAID 5, RAID 6, or RAID 10 volume, you can add a spare disk after the initial RAID is setup. To add a spare disk, follow the steps below:

1. On the **RAID Configuration Screen**, tick the checkbox of the hard disk you wish to designate as a spare disk.
2. Click **Add Spare**. The disk will be configured as a spare disk. The system automatically rebuilds the spare disk when one of the disks in the RAID set fails.

Remote Administration

You can set up your Thecus IP storage for remote administration. With remote administration, you can access your Thecus IP storage over the Internet, even if your Thecus IP storage is behind a router. This is especially useful if you are traveling and suddenly need a file from your Thecus IP storage.

Setting up remote administration is a three-part process, and will require the following equipment:

- Thecus IP storage device
- Cable / DSL Router with Dynamic DNS support
- Home PC
- Internet Connection

NOTE

Router setup will differ slightly depending on router used. For this example, we will use the Asus WL500g because it has support for Dynamic DNS. Contact your router hardware vendor for setup help.

Part I - Setup a DynDNS Account

1. Go to <http://www.dyndns.org> from your home PC.
2. Click on the **Sign Up Now** link.
3. Check the Check boxes, select a user name (i.e.: N8800), enter your email address (i.e.: xxx@example.com), check **Enable Wildcard**, and create a password (i.e.: xxxx).
4. Wait for an email from www.dyndns.org.
5. Open the email and click on the link to activate your account

Part II - Enable DDNS on the Router

1. Go to the router setup screen and select **IP Config > Miscellaneous DDNS Setting** from your Home PC.
2. Click on **Yes** for **Enable the DDNS Client?**
3. Select www.dyndns.org.
4. Go to router setup screen, and enter the following information:
 - a. User Name or E-mail Address: **xxx@example.com**
 - b. Password or DDNS Key: **xxxx**
 - c. Host Name: www.N8800.dyndns.org
 - d. Enable wildcard? Select **Yes**
 - e. Update Manually: Click **Update**

Part III - Setting up Virtual Servers (HTTPS)

1. Navigate to **NAT Setting > Virtual Server**.
2. For **Enable Virtual Server?**, select **Yes**
3. Setup the HTTPS Server
 - a. **Well-Known Applications**: Select **User Defined**
 - b. **Local IP**: Enter 192.168.1.100
 - c. **Port Range**: 443 (the default HTTPS port setting on the Thecus IP storage)
 - d. **Protocol**: select **TCP**
 - e. Click **Add**.
 - f. Click **Apply**.
4. Test the HTTPS connection from another computer on the Internet
 - a. From a remote computer, open your browser and enter <https://www.N8800.dyndns.org>
 - b. You should see the login page of Thecus IP storage.

Firewall Software Configuration

If you are using a software firewall (i.e. Norton Internet Security) and are having trouble connecting to Thecus IP storage, you can try the following steps:

1. Double click the **NIS** icon on system tray, and then configure the **Personal Firewall**.
2. On the **Programs** page, find the **SetupWizard.exe** and change its permission to "Permit All". If it's not in the program list, use the **Add** or **Program Scan** buttons to find it.
3. On the **Networking** page, manually add Thecus IP storage IP address (i.e. 192.168.1.100) to the **Trusted** list.

Replacing Damaged Hard Drives

If you are using RAID 1, RAID 5, or RAID 6 you can easily replace a damaged hard drive in the Thecus IP storage while keeping your data secure with the system's automatic data recovery.

Hard Drive Damage

When a hard drive is damaged and data in the RAID volume, the system LCD will display warning message also the system beeps.

Replacing a Hard Drive

To replace a hard disk drive in Thecus IP storage:

1. Remove the tray with the damaged hard disk (N3200XXX/N0503 is using HDD rail).
2. Unscrew the damaged hard disk and remove it from the tray.
3. Slide a new hard disk into the tray and fasten the screws.
4. Insert the hard disk tray back into Thecus IP storage until it snaps into place. You can also lock it with a key if desired.
5. The LED blinks green when the HDD is accessed.

RAID Auto-Rebuild

When using RAID 1, 5, 6, or 10 on Thecus IP storage, you can use the auto-rebuild function when an error is detected.

1. When a hard disk fails the system beeps and/or an email notification is sent to specified receivers.
2. Check the LCD to see which disk has failed.
3. Follow the steps mentioned above to replace the failed hard disk.
4. The system automatically recognizes the new hard disk and starts the auto-rebuild sequence to resume its status before the hard disk crash.

Chapter 7: Troubleshooting

Forgot My Network IP Address

If you forget your network IP address and have no physical access to the system, you can find out the IP address by either looking directly onto Thecus IP storage LCD panel, or by using the setup wizard to retrieve the IP of your Thecus IP storage.

1. Start the Setup Wizard, and it will automatically detect all Thecus IP storage products on your network.
2. You should be able to find the IP address of Thecus IP storage which you have forgotten in the **Device Discovery** screen.

Can't Map a Network Drive in Windows XP

You may have problems mapping a network drive under the following conditions:

1. The network folder is currently mapped using a different user name and password. To connect using a different user name and password, first disconnect any existing mappings to this network share.
2. The mapped network drive could not be created because the following error has occurred: **Multiple connections to a server or shared resource by the same user, using more than one user name, are not allowed.** Disconnect all previous connections to the server or shared resource and try again.

To check out existing network connections, type `net use` under the DOS prompt. You may refer the URL below for more network mapping information.

http://esupport.thecus.com/support/index.php?_m=downloads&_a=viewdownload&downloaditemid=57&nav=0

Restoring Factory Defaults

From the **System** menu, choose the **Factory Default** item and the **Reset to Factory Default** screen appears. Press **Apply** to reset Thecus IP storage factory default settings.

WARNING

Resetting to factory defaults will not erase the data stored in the hard

Problems with Time and Date Settings

The administrator is able to select an NTP Server to keep Thecus IP storage time synchronized. However, if Thecus IP storage can not access the Internet, you may encounter a problem when setting the Time and Time Zone. If this happens:

1. Login to the Web Administration Interface.
2. Navigate to **System Management>Time**.
3. Under **NTP Server**, select **No**.
4. Set the **Date**, **Time**, and **Time Zone**.
5. Click **Apply**.

In addition, if Thecus IP storage is able to access the Internet and you want to keep the NTP Server clock.isc.org by default, please make sure the DNS Server is correctly entered, thereby allowing the NTP Server name to correctly resolve. (See **System Network > WAN/LAN1 > DNS Server**)

Dual DOM Supports for Dual Protection

The most advance and useful of Thecus IP storage (depend on models) is Dual DOM implemented. In the normal circumstance, it has no need to have this feature involved. But with irresistible cause like power cut or human error by accident occurred especially during system booting stage, this will become the great feature to prevent system down time.

Practically while it happened, system will try to recovery the DOM 1 from DOM 2 first. If it is unachievable then system can boot from DOM 2. And all of this procedure can be operated by LCM.

NOTE

The Dual DOM in DOM1 is default master and FW upgrading will only execute in DOM1 unlike DOM2 is 'Read only' initially.

Any circumstance occurred, while DOM2 successes recover DOM1. The FW will be version of DOM2. Therefore, it may need to upgrade to the version of DOM1 it has.

If DOM1 can not be recovery from DOM2, then system will boot up from DOM2. The original configuration in DOM1 may need to setup again with DOM2 operation.

Chapter 8: Updated for FW v5.02.01

Changes of FW v5.02.01

- Module login through UI Login Interface
- UI Login function
- Modified share folder "Edit" setup item and add "samba" setting
- Add NFS 4.0 support
- Add NFS sync/Async option
- Add mode option for Samba setting
- FTP has add option "External IP" for NAT port forwarding
- Add web service v1.x SSL certificate input
- Migrate rsync function to dedicate FW from module install required
- Add User Quota function
- Add User and Group backup
- Add ACL backup/Restore
- Added network UPS supported

Add module login through UI Login Interface

From the login page, other than admin, web disk and Piczza (Photo server) the module has newly added from this FW release. So after module has been installed there is new option can be chosen "Show in Login".

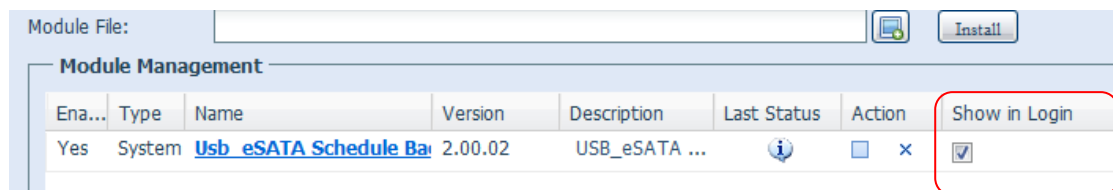

If this option has enabled then while login to the system, the modules will have associated icon to allow all of valid users to login through.



UI Login Configuration

Adjusts UI Login Configuration settings, you can enable/disable the Web Disk, Photo Server and modules functions, according to your needs.

For the 3X series, users need to install the photo server module or web disk module to access these functions.

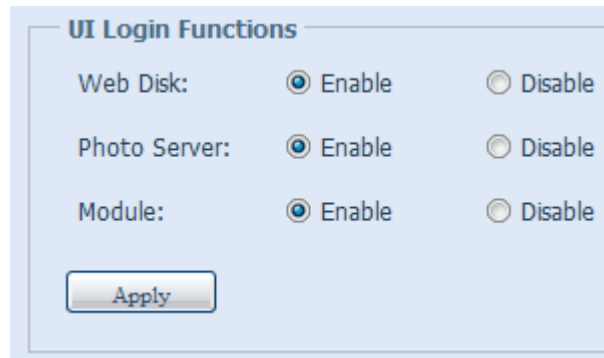

Share Folder

From the **Storage** menu, choose **Share Folder**, and the **Folder** screen appears. This screen allows you to create and configure folders on the Thecus IP storage volume.

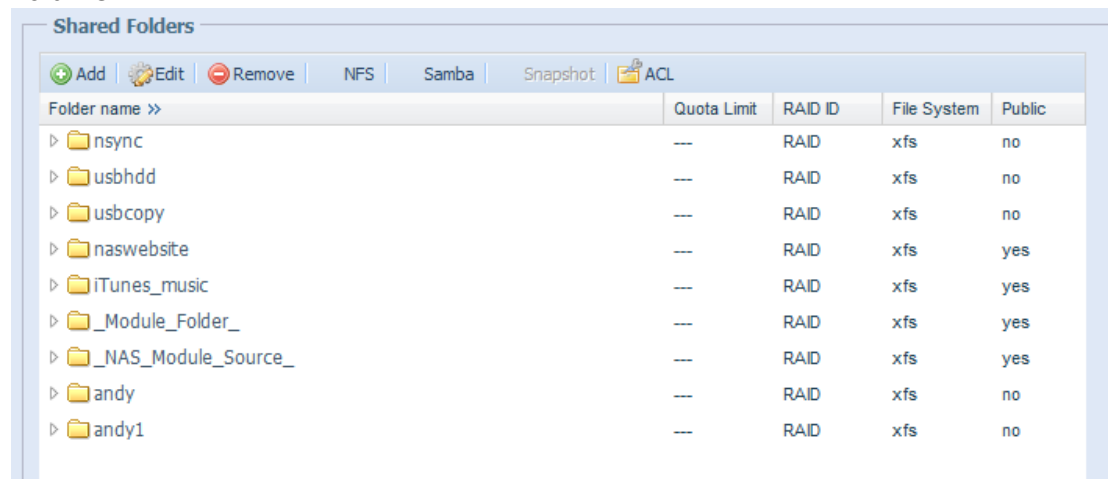

Adding Folders

On the **Folder** screen, press the **Add** button and the **Add Folder** screen appears. This screen allows you to add a folder. After entering the information, press **Apply** to create new folder.

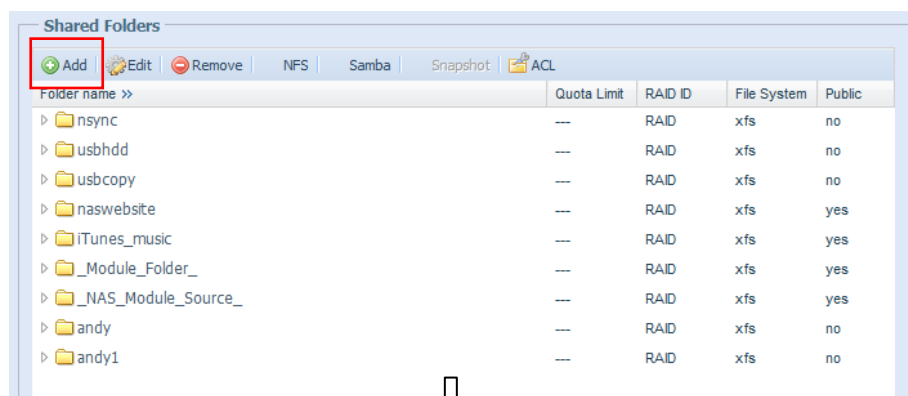

Modify Folder	
Item	Description
RAID ID	RAID volume where the folder will reside.
Folder Name	Enter the name of the folder.
Public	Admit or deny public access to this folder.
Share Limit	Enter the maximum size of the folder. The folder will not grow beyond this limit. You can enter a 0 to turn off the share folder limit.
Apply	Press Apply to create the folder.

Modify Folders

On the **Folder** screen, press the **Edit** button and the **Modify Folder** screen appears. This screen allows you to change folder information. After entering the information, press **Apply** to save your changes.

Modify Folder	
Item	Description
RAID ID	RAID volume where the folder will reside.
Folder Name	Enter the name of the folder.
Public	Admit or deny public access to this folder.
Share Limit	Enter the maximum size of the folder. The folder will not grow beyond this limit. You can enter a 0 to turn off the share folder limit.
Apply	Press Apply to activate settings.

NFS Share

To allow NFS access to the share folder, enable the **NFS Service**, and then set up hosts with access rights by clicking **Add**.

The NFS is now supporting both v3.0 and v4.0. Please be noticed the mounting point indicated on the top left of "Config NFS share" page. Let's take example for system share folder "andy1":

NFS3 Mount point: /raid0/data/_NAS_NFSExports_/andy1

NFS4 Mount point: /andy1

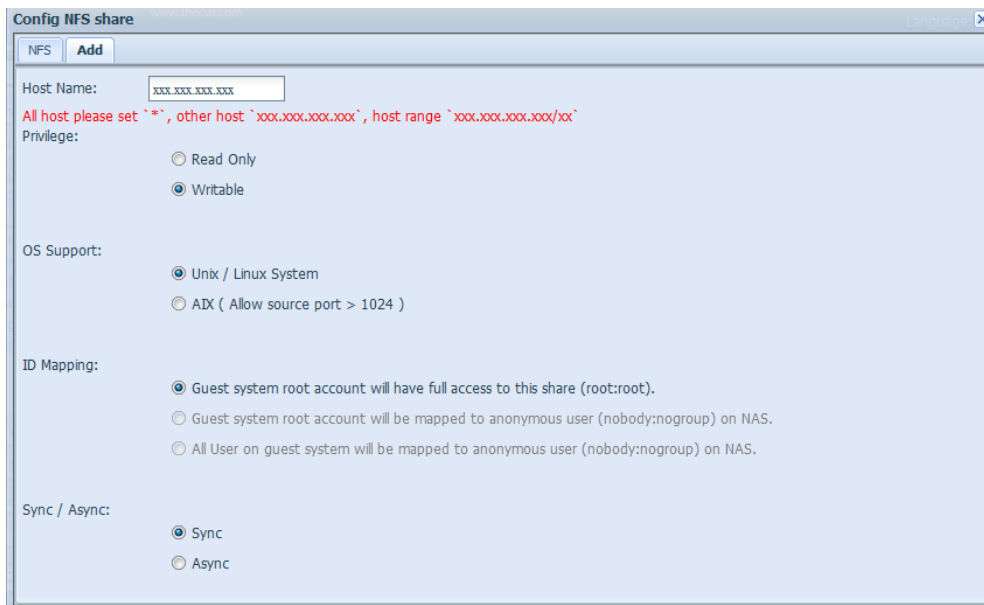
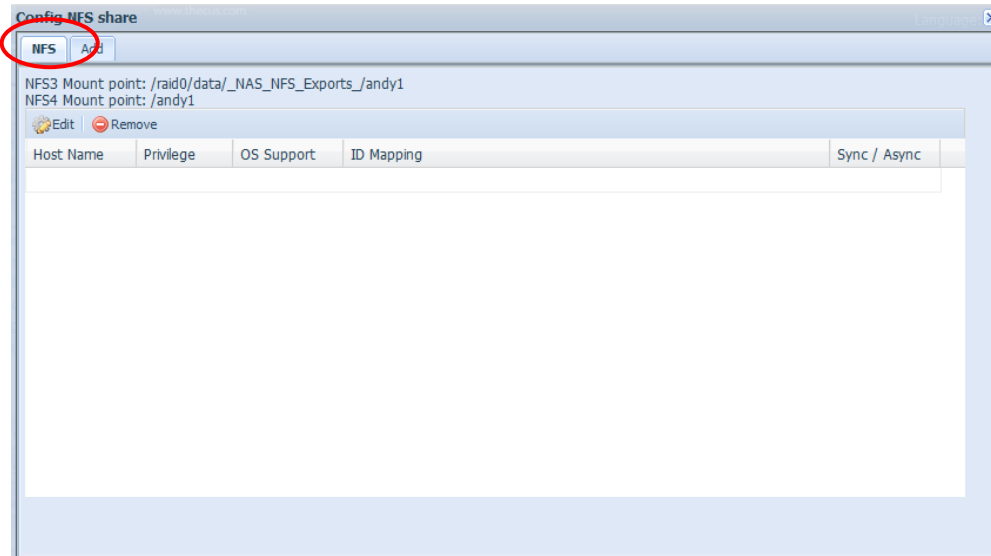

NFS Share	
Item	Description
Hostname	Enter the name or IP address of the host
Privilege	Host has either read only or writeable access to the folder.
Guest System Support	There are two selections available: <ul style="list-style-type: none"> • Unix / Linux System • AIX (Allow source port > 1024) Choose the one which best fits your needs.
OS Support	Choose the client OS used either Linux/Unix or AIX system.
IO Mapping	There are three selections available: <ul style="list-style-type: none"> • Guest system root account will have full access to this share (root:root).

	<ul style="list-style-type: none"> • Guest system root account will be mapped to anonymous user (nobody:nogroup) on NAS. • All user on guest system will be mapped to anonymous user (nobody:nogroup) on NAS. <p>Choose the one which best fits your needs.</p>
Sync / Async	Choose to determine the data "Sync" at once or "Async" in arranged batch. To choose "Async" could have better throughput but risky if system getting trouble like power cut may loose the data which still in memory buffer and not yet write to disk.
Apply	Click to save your changes.

Samba Configuration

On the **Folder** screen, press the **Samba** button and the **Samba Configuration** screen appears. This screen allows you to setup samba configuration for associated folder. After entering the information, press **Apply** to activate input settings.

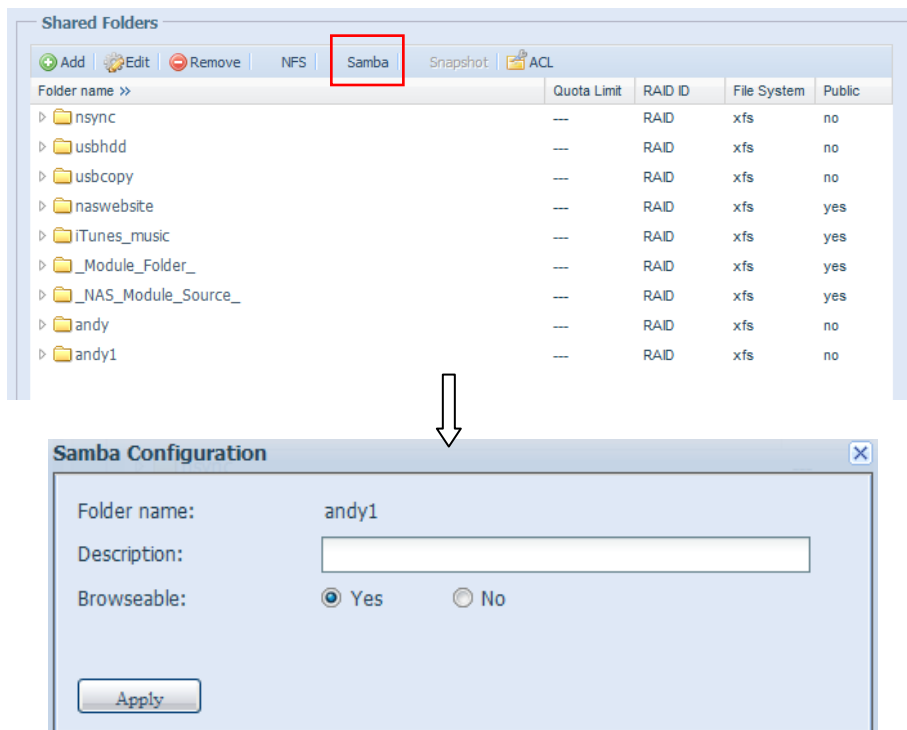

Add Folder	
Item	Description
Folder Name	Enter the name of the folder.
Description	Provide a description for the folder.
Browseable	Enable or disable users from browsing the folder contents. If Yes is selected, then the share folder will be browseable.
Apply	Press Apply to activate settings.

User Quota

The User Quota provides a way of limiting users' available storage capacity. Setting a user quota gives a given user a given amount of space on EACH RAID partition. For example, if there are 3 RAID partitions and a user has a user quota of 300MB, the user can store 300MB of data on EACH RAID partition, or a total of 900MB of data.

The framework keeps track of the total amount of data a user has used across different folders and functions such as the photo server.

Please do enable the user quota function first. Then you could choose "Sync" to calculate for all of users to each associated RAID volume with used space.

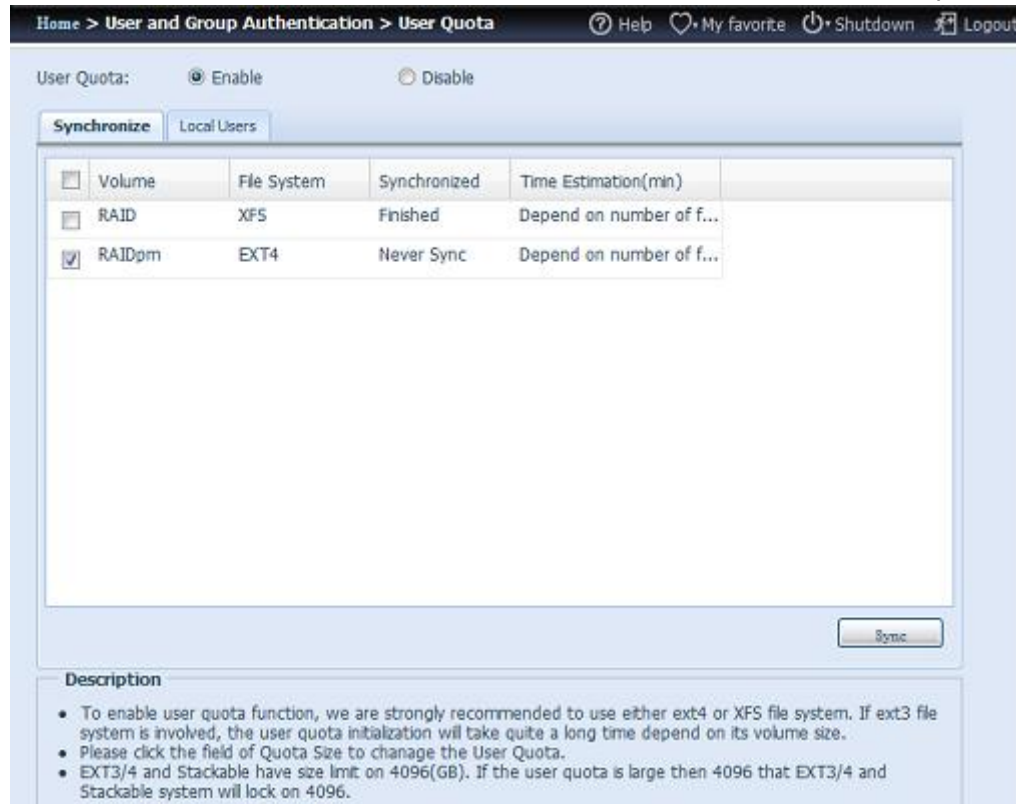

NOTE

Please do execute "Sync" if user quota has been disable then enable again to make sure the accuracy of quota used for each user. Or the user used capacity will not count during user quota function is disabled.

To setup user quota, simply click on desired user with associated "Quota" filed then input numbers. Left default value "0" with no quota limitation for associated users. Please be sure the "Apply" button has confirmed for changes.

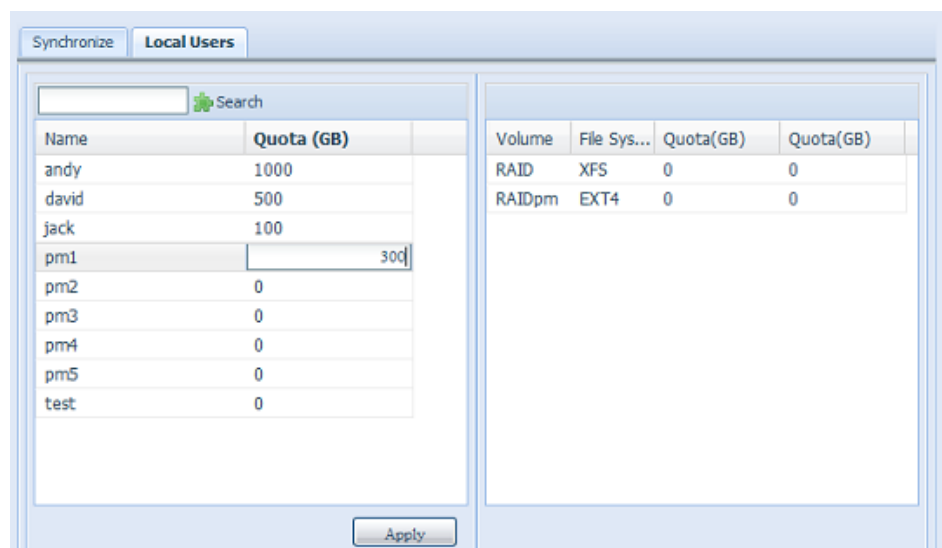

Click on user and right hand pane will list associate system RAID volume with setup quota and used size.

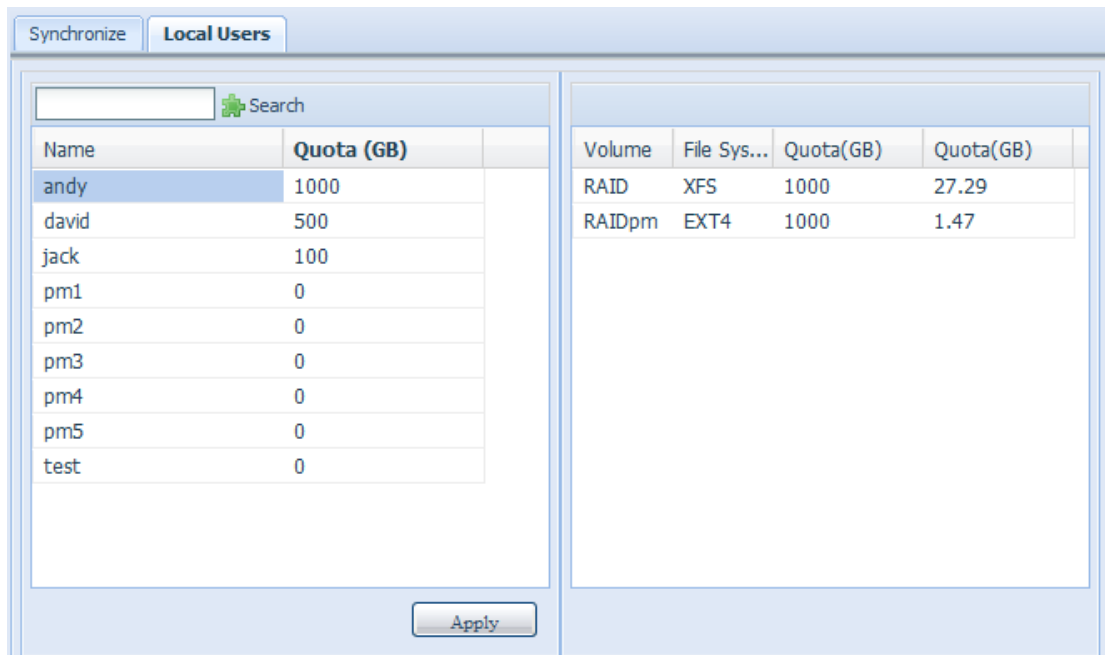

The screenshot shows a web interface with two panes. The left pane is titled 'Local Users' and contains a search bar and a table of users. The right pane contains a table of RAID volumes. At the bottom of the interface is an 'Apply' button.

Name	Quota (GB)
andy	1000
david	500
jack	100
pm1	0
pm2	0
pm3	0
pm4	0
pm5	0
test	0

Volume	File Sys...	Quota(GB)	Quota(GB)
RAID	XFS	1000	27.29
RAIDpm	EXT4	1000	1.47

User and Group Backup

The user and group backup feature is allowed system users and groups been backup to other location and restore it while needed.

Please be noticed when restore previous backup users and groups, the current users and groups list will be replaced from this restore file's contents.



The screenshot shows a web interface titled 'User and group settings download/upload'. It features an 'Upload:' label, a text input field with the placeholder 'Please choose a file to upload', and a file selection icon. Below the input field are two buttons: 'Upload' and 'Download'.

Samba / CIFS

There are options allow Admin to Enable/Disable to operate Thecus IP storage associated with Samba / CIFS protocol. With the option changed, it will need to reboot system to activate.

Samba/CIFS			
Samba Service:	<input checked="" type="radio"/> Enable	<input type="radio"/> Disable	
File Access Cache:	<input checked="" type="radio"/> Enable	<input type="radio"/> Disable	
Samba Anonymous Login Authentication:	<input type="radio"/> Enable	<input checked="" type="radio"/> Disable	
Samba Native Mode:	<input checked="" type="radio"/> Yes (Native Mode)	<input type="radio"/> No (Compatible Mode)	
Optimize Block Size:	<input checked="" type="radio"/> Enable	<input type="radio"/> Disable	
Windows Server Backup to NAS:	<input type="radio"/> Folder backup(File-level)	<input checked="" type="radio"/> Full backup (Block-level)	
Server Signing:	<input type="radio"/> Auto	<input type="radio"/> Mandatory	<input checked="" type="radio"/> Disable

Samba Service

Used for letting the operating system of UNIX series and SMB/CIFS of Microsoft Windows operating system (Server Message Block / Common Internet File System). Do the link in network protocol. Enable or Disable SMB/CIFS protocol for Windows, Apple, Unix drive mapping.

NOTE

- In some environments, due to security concerns, you may wish to disable SMB/CIFS as a precaution against computer viruses.

File Access Cache

File Access Cache is default **Enable**. This option will help to increase the performance while single client access share folder in writing under SMB/CIFS protocol.

Samba Anonymous Login Authentication

To enable this option, no matter there is share folder has been created in public access. The user account and password is needed from system to access under SMB/CIFS protocol. On the other hand, no more anonymous login is allowed.

Samba is Native mode

The Thecus IP storage is supported Samba mode options. In the ADS environment with "Native" mode selected then Thecus IP storage is capable to become local master position.

Optimize Block Size

This function controls the behavior of Samba when reporting available disk space. This function was added to allow advanced administrators to increase block size to increase write performance without re-compiling the code.

Disabled= 4k Enabled=256k

Windows Server Backup to NAS

The Windows Server 2008 has built-in backup solution. If the backup source is whole Windows system please choose "Full backup" otherwise "Folder backup".

Server Signing

This is setting while Samba server has been used in US of FDCC. If the system has used only in Windows environment choose "Mandatory" otherwise "Auto".

Samba/CIFS Options for Mac OS X

Allocated buffering size: Enable Disable

UNIX Extensions: Enable Disable

Hide Temporary Files: Enable Disable

Allocated Buffering Size

This parameter allows an administrator to adjust the size of the buffer dedicated to Samba clients. The default size of 2GB generally results in improved Samba client performance. However, Mac OS X may incorrectly display file sizes under 2GB.

UNIX Extension

The default is enable for Samba usage, with situation using Mac OSX with smb connection may have permission issue. When it happened, please setup "UNIX Extension" disable to get issue solved.

Hide Temporary Files

If enabled, it will hide Mac OS X temporary files on the NAS when viewed in Windows.

Samba/CIFS Options for Recycle Bin

Samba Recycle Bin: Enable Disable

Recycle bin contents are deleted after: days (Set as 0 for manual deletion only)

Recycle Bin Folder Display: Enable Disable

Recycle Bin Max File Size: GB (Set as 0 for unrestricted)

Samba Recycle Bin

The Thecus IP storage is supported recycle bin via SMB/CIFS protocol.

Simply enable the "Recycle Bin" function and "Recycle Folder Display" then all of deleted files/folders will reside in the "_NAS_Recycle_(Associated RDID Volume)" share folder.

Samba/CIFS Options for Recycle Bin

Samba Recycle Bin: Enable Disable

Recycle bin contents are deleted after: days (Set as 0 for manual deletion only)

Recycle Bin Folder Display: Enable Disable

Recycle Bin Max File Size: GB (Set as 0 for unrestricted)

For example, the system has created 2 RAID volumes with ID "RAIDpm" and "RAID". Then it will have 2 recycle bin folder appear as "_NAS_Recycle_RAID" and "_NAS_Recycle_RAIDpm".

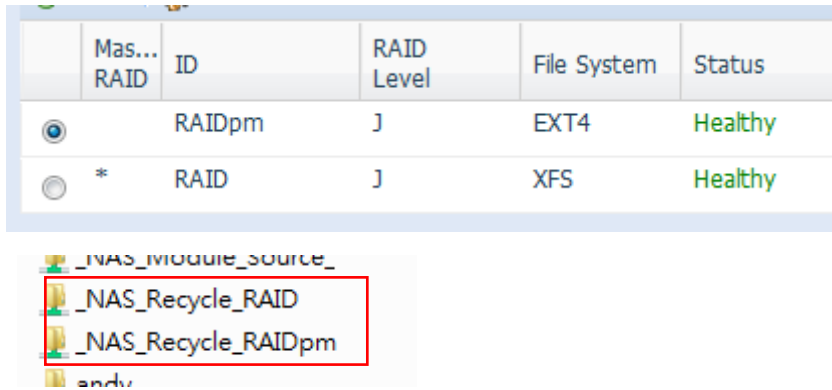

There are 2 more setting could help to manage the recycle bin for deleted folders/files.

1. Setup the "Day" to remove deleted folders/files which has resided in recycle bin permanently. Left default value "0" if desired to clean up recycle bin manually.
2. Setup the "Size" for recycle bin to allow deleted folders/files can store. Left default value "0" with no limitation.

NOTE

- The deleted files/folders which have resided in recycle bin will keep its permission. On the other hand, only the admin and owner can view/read/write these folders/files.
- If deleted single file size is large than 2GB then it won't reside in the recycle bin but erase permanently.

FTP

Thecus IP storage can act as a FTP server, enabling users to download and upload files with their favorite FTP programs. From the **Network Service** menu, choose the **FTP** item, and the **FTP** screen appears. You can change any of these items and press **Apply** to confirm your settings.

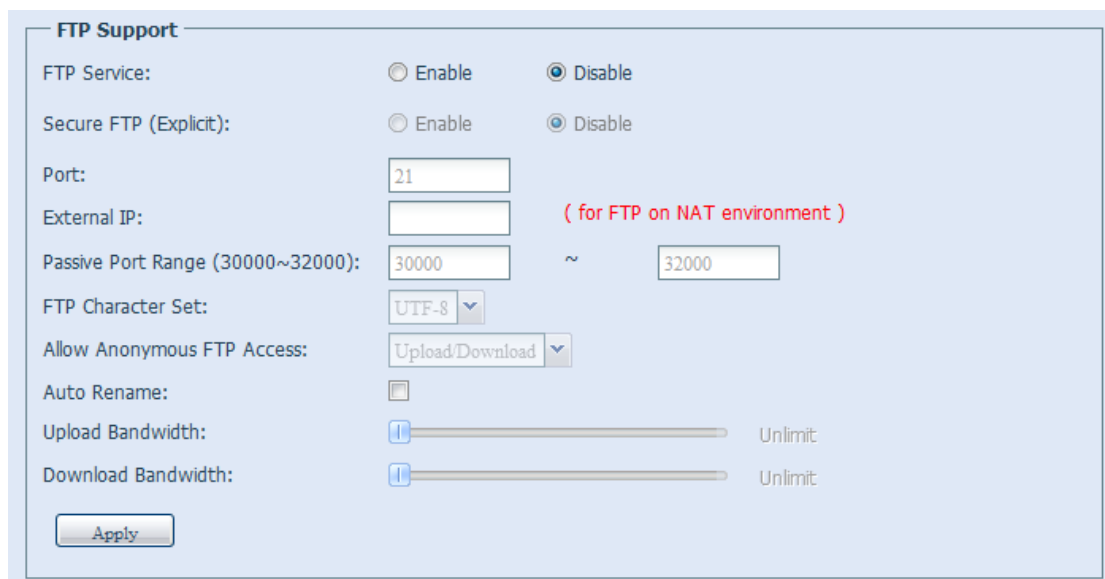

A description of each item follows:

FTP	
Item	Description
FTP	Enable FTP Service on Thecus IP storage.
Security FTP	Enable or disable Security FTP, be sure the client FTP software has also security FTP setting enabled.
Port	Specifies the port number of an incoming connection on a non-standard port.
External IP	Input the public IP address of router while Thecus secure FTP server has been enabled. It could help to response ftp client with correct communicate information.
Passive Port Range (30000-32000)	limited port range for the FTP server to use.
FTP ENCODE	If your FTP client or operating system does not support Unicode (e.g. Windows® 95/98/ME or MAC OS9/8), select the same encoding as your OS here in order to properly view the files and directories on the server. Available options are BIG5, HZ, GB2312, GB18030, ISO, EUC-JP, SHIFT-JIS and UTF-8.
Allow Anonymous FTP Access	Upload/Download: Allow anonymous FTP users to upload or download files to/from public folders. Download: Allow anonymous FTP users to download files from public folders. No access: Block anonymous FTP user access.
Auto Rename	If checked, the system will automatically rename files that are uploaded with a duplicate file name. The renaming scheme is [filename].#, where # represents an integer.
Upload Bandwidth	You may set the maximum bandwidth allocated to file uploads. Selections include Unlimited, 1, 2, 4, 8, 16 and 32 MB/s .
Download Bandwidth	You may set the maximum bandwidth allocated to file downloads. Selections include Unlimited, 1, 2, 4, 8, 16 and 32 MB/s .

WebService (HTTP/ Web Disk)

From the **Network Service** menu, choose the **HTTP/ Web Disk** item, and the **WebService** screen appears. This screen displays the service support parameters of the system. You can change any of these items and press **Apply** to confirm your settings.

Home > Network Service > WebService

Help My favorite Shutdown Logout

WebService (HTTP) Support

Sharing: Enable Disable

Port:

Secure WebService (Secure HTTP) Support

Sharing: Enable Disable

Port:

Certificate Type: User System

Certificate File:

Certificate Key File:

CA Certificate File:

Apply

Description

1. If a file error occurs with an uploaded SSL certificate file, default settings will be used automatically.
2. The SSL certificate file needs to reload after the master RAID partition has been changed.
3. The setting did not apply for Web Disk v2.x.x and after.

A description of each item follows:

Web Service	
Item	Description
HTTP (WebDisk) Support	Enable or disable WebDisk support. Enter the port number if this option is enabled. The port number is default 80.
HTTPs (Secure WebDisk) Support	Enable or disable secure WebDisk support. Enter the port if this option is enabled.
Certificate Type	Select "User" if there is available Certification ID ex. Apply from VeriSign. Or using system default by select "System".
Certificate File	Upload Certificate File if choose Certificate type "User".
Certificate Key File	Upload Certificate Key File if choose Certificate type "User".
CA Certificate File	Upload CA Certificate File if choose Certificate type "User".
Restore All SSL Certificate Files	Click to set back to default certification details.
Apply	Click "Apply" to confirm the changes.

NOTE

- Disable HTTP support and Enable Secure HTTP support to guarantee secure access.

NOTE

- The WebDisk has 2 different versions. The version v1.x which is come with FW together may apply the setting here. The version v2.x is needed to install through module interface and will not apply setting here.
- For the models N4200 series, N0503, N7700 series and N8800 series could choose either version to use.
- All other models can only use version v2.x

Rsync Target Server

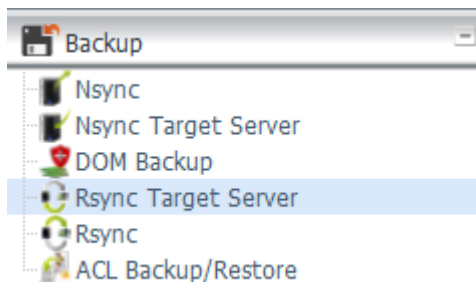

When it comes to backing up your data, it's very important to have flexibility. Rsync Backup provides you with many options, including local or remote backup, backup scheduling, different synchronization settings, and password protection. Being based on the Linux operating system, it is also much more stable and experiences much less frequent data loss during transfer than other remote backup systems.

-For this tutorial you will need to use Rsync Target Server (Step 1) and Rsync (Step 2+3) under Backup for this client/server backup feature. It also can be named If function "Remote Replication".

Step 1 – Enabling Rsync on your target (backup) NAS

- Log in to your target (backup) NAS through the UI in your web browser
- Go to Rsync Target Server under Backup in the menu of the UI

1. Enable **Rsync Target Server**
2. Add a **username** and **password** (they can be different than your NAS's username and password)
3. Select **Apply**

NOTE

- You will need this user name and password while the data is going to remotely backup to this rsync target server.

*Now Rsync is turned on your NAS, which means it can be used as a target for Rsync backup, in other words, only the backup NAS needs to be activated in this way.

Rsync

Step 2 – Setting up your backup task and schedule on your source NAS

- Log in to your other NAS (your source NAS) through the UI in your web browser
- Go to **Rsync** under **Backup** in the menu of the UI

- From the **Rsync Schedule Backup** task list, choose **Add**

Task name	Source Folder	Schedule	Target Server/Path	Last Time	Last Status	Action
-----------	---------------	----------	--------------------	-----------	-------------	--------

-Fill out all the necessary details and choose your parameters

Add Rsync Backup Task	
Item	Description
Task Name	This is how it will appear in the task list.
Task Description	Describe the task details.
Backup Mode	Synchronization mode: Makes your source match your target completely; deleting and adding files on your target as they are deleted and added on your source. Incremental Mode : Makes your source match your target and keep all old files; adding files on your target as they are added on your source, but NOT deleting files on your target as they are deleted on your source.
Source Folder	Choose the folders from drop down lists on your source NAS that you wish to backup.
Target Server : Port	Input the Rsync Target Server IP address which you are going to backup over, port number has no need to change only if the default port number has been used in other purpose.
Destination Path / Sub-folder	Input existed Rsync target server share folder path to backup source over. The sub-folder may left blank if it is not apply.
User name and Password	This is the username and password need to fill in for associate "Rsync Target Server" that you are going to copy data over.
Log Folder	Choose the folder to save the log details while rsync task is executed.
Test Connection	If there is an error, review the instructions and make sure all necessary fields has filled correctly.
Schedule	To run Rsync backup manually please choose "Disable" or "Enable" the schedule to execute the Rsync task.
Add	This saves your Rsync backup task and will list in task list.

Step 3 – Manually edit or run your backup tasks

After selecting “apply”, you will be brought back to the Rsync Schedule Backup task list.

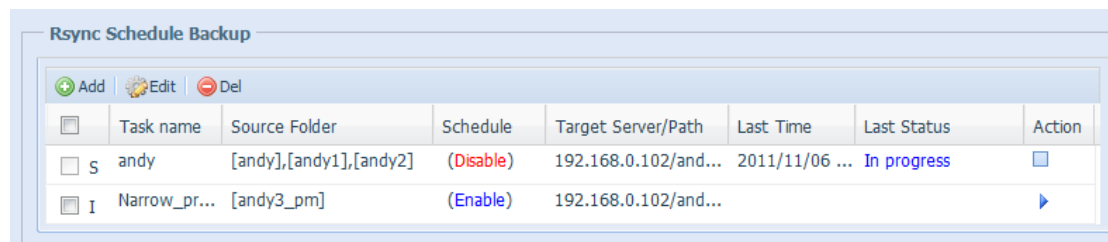

Simply click the arrow on the Action section to start the task and click the box to cancel the ongoing task. If any setting needs to be changed for task, tick the check box in front of associated task then press “Edit” button to bring up the screen.

NOTE

The “S” sign in each task is denoted “Synchronize” and “I” is denoted “Incremental” for backup mode of associate task.

ACL Backup and Restore

The ACL backup and restore feature are allowed system ACL (Access Control List) been backup on RAID volume based to other location and restore it while needed.

Let’s take example to see how it works.

There is system with RAID volume “RAID”, select “Backup” to backup this RAID volume’s ACL to other location. The current RAID volume “RAID” has share folder as listed on right hand screen shot.

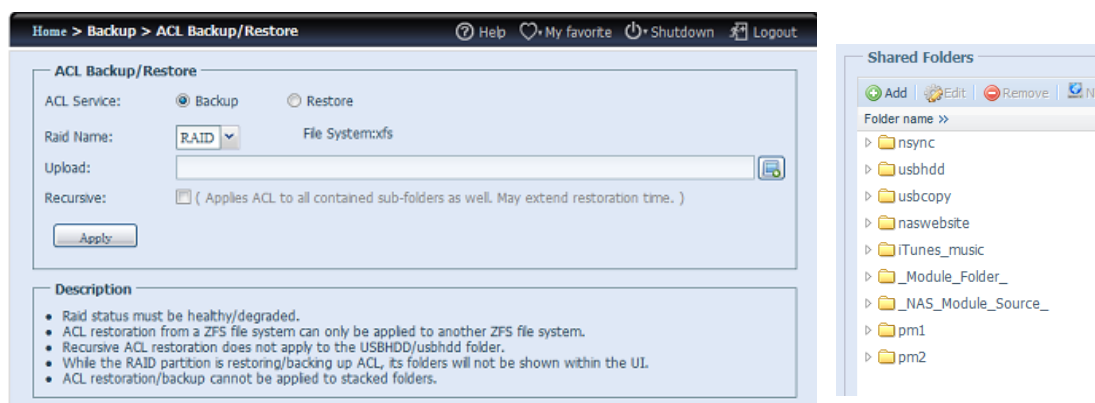

For the ACL restore, it could be restored in same system or used in other unit. For example, restore the ACL backup file to other unit. This unit has RAID volume “RAIDpm” with share folder as listed on right hand screen shot.

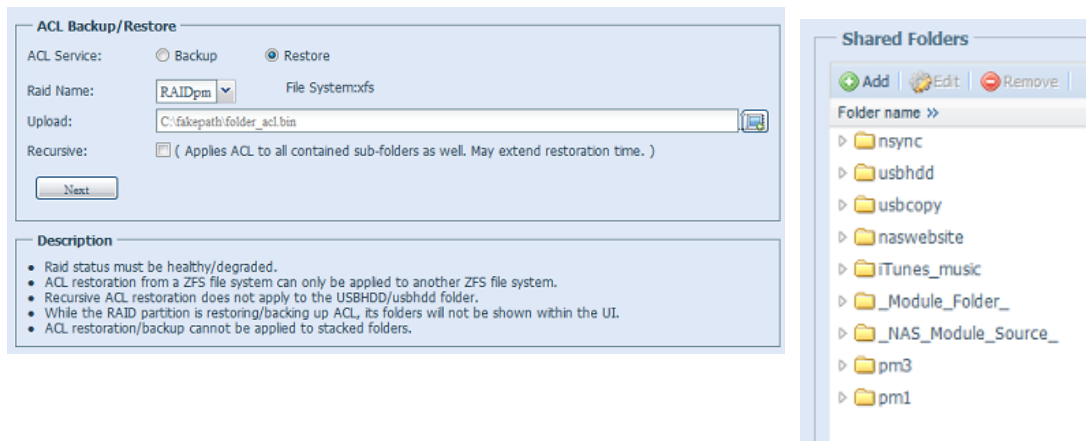

After input the ACL backup file and click "Next" button, system will come out the screen to list matched folders in between backup file and this RAID volume. Just select the desired folders for ACL restore.

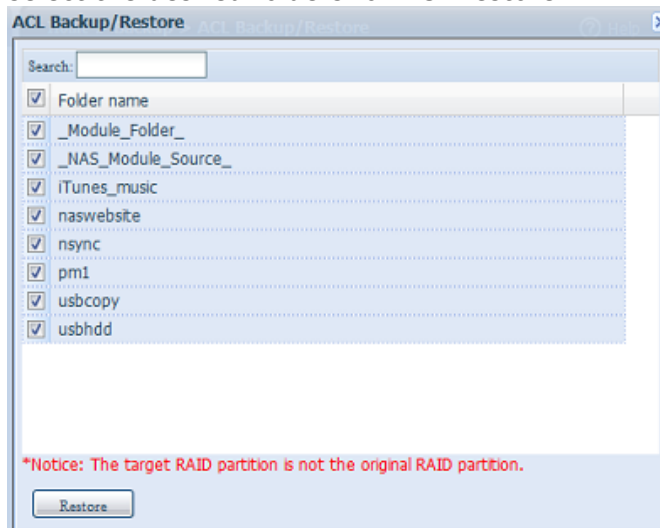

NOTE

- The ACL backup will only backing the share folder level, no apply to its sub-layer.
- The ACL backup/restore can be used among ext3/ext4/XFS file system but ZFS can only be used with other RAID volume with ZFS file system created while backup/restore.
- If recursive has been checked during ACL restoration, it will apply all of its sub-folder with same permission.

Uninterrupted Power Source (UPS Setting)

The Thecus IP storage can also support various uninterruptible power supply unit via either "Serial" or "USB" interface (depend on model) to provide extra data security and accessibility in the case of a power failure. Additionally, the network UPS is also supported.

From the **Status** menu, choose the **UPS** item and the **UPS Setting** screen appears. Make any changes you wish, and press **Apply** to confirm changes.

UPS Settings

UPS Monitoring: Enable Disable

Remote UPS Monitoring: Enable Disable

Remote UPS IP:

Manufacture: ▼

Model: ▼

**product has been tested for compatibility*

Battery Status: N/A

Power: N/A

Seconds between power failure and first notification 5 seconds

Seconds between subsequent power failure notifications 20 seconds

Shutdown the system when the battery charge is less than 5 %

See the following table for a detailed description of each item.

UPS Setting	
Item	Description
UPS Monitoring	Enable or disable UPS monitoring.
Remote UPS Monitoring	Enable or disable Remote UPS monitoring.
Remote UPS IP	Input the IP address of your network UPS.
Manufacturer	Choose the UPS manufacturer from the dropdowns.
Model	Choose the UPS model number from the dropdowns.
Battery Status	Current status of the UPS battery
Power	Current status of the power being supplied to the UPS
Seconds between power failure and first notification	Delay between power failure and first notification in seconds.
Seconds between subsequent power failure notifications	Delay between subsequent notifications in seconds.
Shutdown the system when the battery charge is less than	Amount of UPS battery remaining before system should auto-shutdown.
Apply	Press Apply to save your changes.

Link Aggregation mode description

Field	Description
Load Balance (Balance-rr) (Round-Robin)	Round-robin policy: Transmit packets in sequential order from the first available slave through the last. This mode provides load balancing and fault tolerance.
Failover (Active-Backup)	Active-backup policy: Only one slave in the bond is active. A different slave becomes active if, and only if, the active slave fails. The bond's MAC address is externally visible on only one port (network adapter) to avoid confusing the switch. This mode provides fault tolerance. The primary option affects the behavior of this mode.

Balance XOR	XOR policy: Transmit based on [(source MAC address XOR'd with destination MAC address) modulo slave count]. This selects the same slave for each destination MAC address. This mode provides load balancing and fault tolerance.
802.3ad	<p>IEEE 802.3ad Dynamic link aggregation. Creates aggregation groups that share the same speed and duplex settings. Utilizes all slaves in the active aggregator according to the 802.3ad specification.</p> <p><i>Pre-requisites:</i></p> <ol style="list-style-type: none"> 1. <i>Ethtool support in the base drivers for retrieving the speed and duplex of each slave.</i> 2. <i>A switch that supports IEEE 802.3ad Dynamic link aggregation.</i> <p><i>Most switches will require some type of configuration to enable 802.3ad mode.</i></p>
Balance-TLB	Adaptive transmit load balancing: channel bonding that does not require any special switch support. The outgoing traffic is distributed according to the current load (computed relative to the speed) on each slave. Incoming traffic is received by the current slave. If the receiving slave fails, another slave takes over the MAC address of the failed receiving slave. receiving slave. Balance-TLB mode provides load balancing and fault tolerance.
Balance-ALB	Adaptive load balancing: includes balance-tlb plus receive load balancing (rlb) for IPV4 traffic, and does not require any special switch support. The receive load balancing is achieved by ARP negotiation. The bonding driver intercepts the ARP Replies sent by the local system on their way out and overwrites the source hardware address with the unique hardware address of one of the slaves in the bond such that different peers use different hardware addresses for the server.

Chapter 9: Updated for FW v5.03.01

Changes of FW v5.03.01

- Added system monitor

System Monitor

The system monitor is capable to monitor system status including CPU/memory utilization, fan/temperature status, network throughput and on-line user list in various protocols.

To monitor system status, simply click on "System Monitor" from the tree menu and the screen will appear as below.

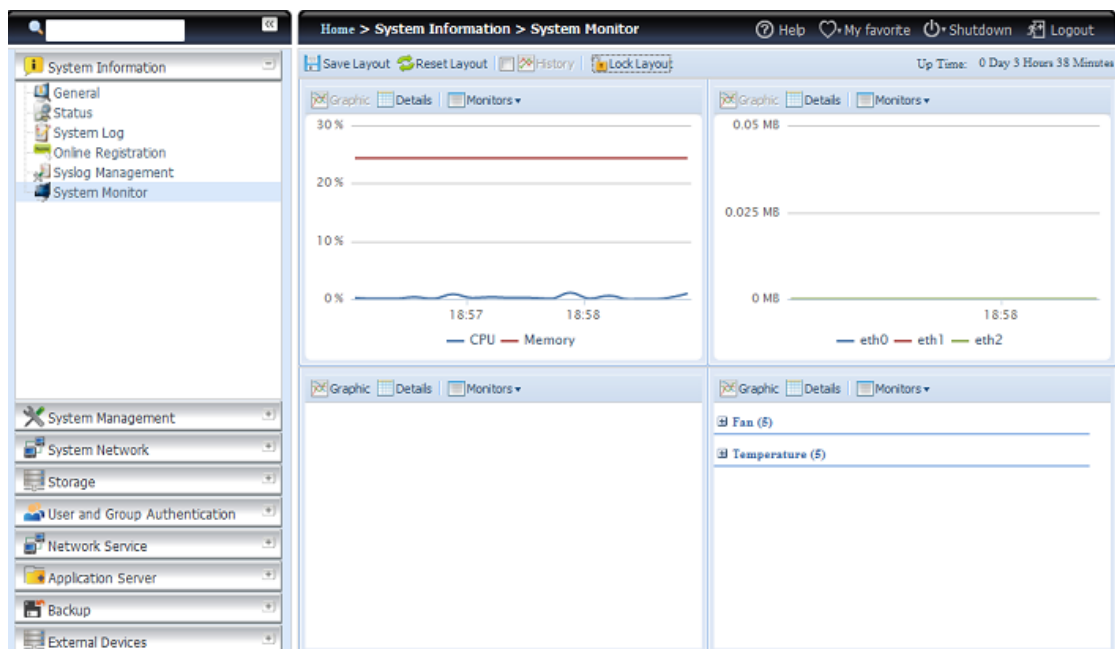

It is divided into 4 sections. Each section can be modified to monitor specific items by using the drop down list from the "Monitors" tab, simply click on the items you would like to monitor. From each section, you can also choose to display the information graphically by selecting "Graphic" or by plain text mode by selecting "Details".

NOTE

Only 2 sections can be set in graphic mode at the same time.

If graphic mode is chosen, 3 minutes of information is displayed on the x-axis. A resume of the information is displayed by dragging the mouse over the graphic at a specific time. See example below:

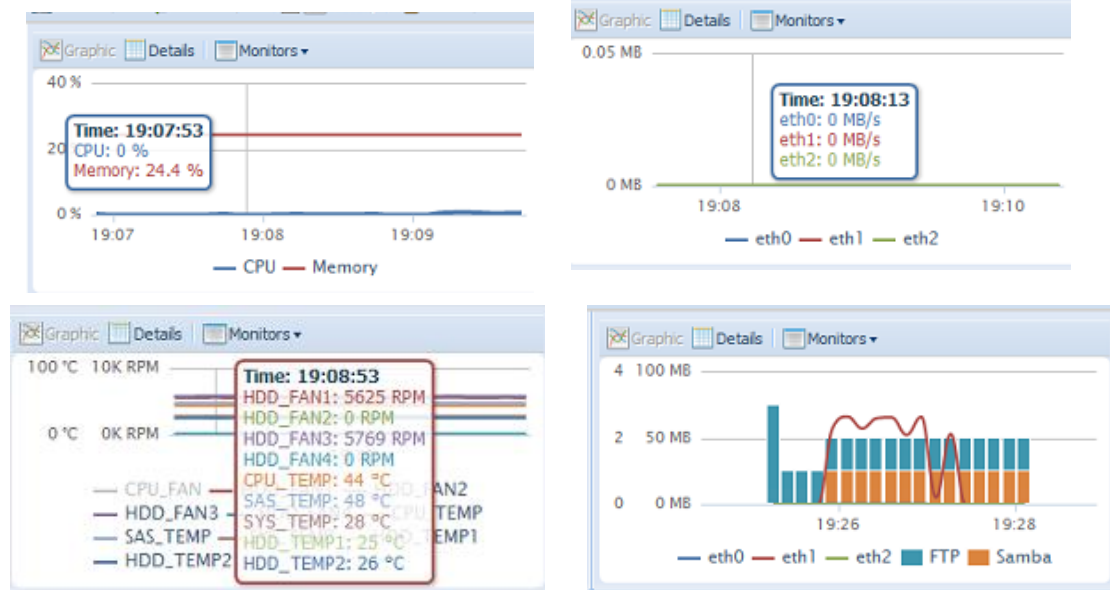

For the on-line users list, system monitor will display the on-line users and the share folder they have visited.

System Monitor		
CPU (1)		
Sys	0.75 %	
FTP (1)		
172.16.64.138	andy	_NAS_Picture_
Samba (1)		
172.16.64.138	root	test

System Monitor	
Item	Description
Save Layout	Saving selected monitoring items. Layout will remain the same for future visits.
Reset Layout	Set back to default monitoring settings and layout.
History	Click on this check box and system monitor will write the monitoring history to a designate path in the RAID volume.
Lock Layout	All of the monitoring items are fixed and cannot be changed. Click again to unlock it.

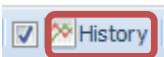
If the History has been enabled, click on  and system monitor will display the history with different period for selection.

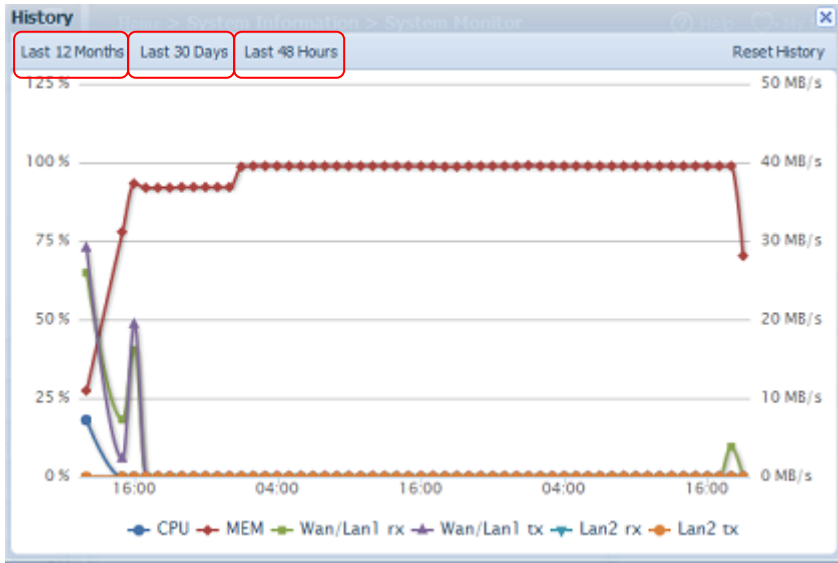

Appendix A: Customer Support

If your Thecus IP storage is not working properly, we encourage you to check out **Chapter 7: Troubleshooting**, located in this manual. You can also try to ensure that you are using the latest firmware version for your Thecus IP storage. Thecus is committed to providing free firmware upgrades to our customers. Our newest firmware is available on our Download Center:

<http://www.thecus.com/download.php>

If you are still experiencing problems with your Thecus IP storage, or require a Return Merchandise Authorization (RMA), feel free to contact technical support via our Technical Support Website:

http://www.thecus.com/support_tech.php

Customers in the US should send all technical support enquiries to the US contact window included in the following web page:

http://www.thecus.com/support_tech.php

For Sales Information you can e-mail us at:

sales@thecus.com

Thank you for choosing Thecus!



Appendix B: RAID Basics

Overview

A Redundant Array of Independent Disks (RAID) is an array of several hard disks that provide data security and high performance. A RAID system accesses several hard disks simultaneously, which improves I/O performance over a single hard disk. Data security is enhanced by a RAID, since data loss due to a hard disk failure is minimized by regenerating redundant data from the other RAID hard disks.

Benefits

RAID improves I/O performance, and increases data security through fault tolerance and redundant data storage.

Improved Performance

RAID provides access to several hard disk drives simultaneously, which greatly increases I/O performance.

Data Security

Hard disk drive failure unfortunately is a common occurrence. A RAID helps prevent against the loss of data due to hard disk failure. A RAID offers additional hard disk drives that can avert data loss from a hard disk drive failure. If a hard drive fails, the RAID volume can regenerate data from the data and parity stored on its other hard disk drives.

RAID Levels

The Thecus IP storage supports standard RAID levels 0, 1, 5, 6, 10, and JBOD. You choose a RAID level when you create a system volume. The factors for selecting a RAID level are:

- Your requirements for performance
- Your need for data security
- Number of hard disk drives in the system, capacity of hard disk drives in the system

The following is a description of each RAID level:

RAID 0

RAID 0 is best suited for applications that need high bandwidth but do not require a high level of data security. The RAID 0 level provides the best performance of all the RAID levels, but it does not provide data redundancy.

RAID 0 uses disk striping and breaking up data into blocks to write across all hard drives in the volume. The system can then use multiple hard drives for faster read and write. The stripe size parameter that was set when the RAID was created determines the size of each block. No parity calculations complicate the write operation.

RAID 1

RAID 1 mirrors all data from one hard disk drive to a second one hard disk drive, thus providing complete data redundancy. However, the cost of data storage capacity is doubled.

This is excellent for complete data security.

RAID 5

RAID 5 offers data security and it is best suited for networks that perform many small I/O transactions at the same time, as well as applications that require data security such as office automation and online customer service. Use it also for applications with high read requests but low write requests.

RAID 5 includes disk striping at the byte level and parity information is written to several hard disk drives. If a hard disk fails the system uses parity stored on each of the other hard disks to recreate all missing information.

RAID 6

RAID 6 is essentially an extension of RAID level 5 which allows for additional fault tolerance by using a second independent distributed parity scheme (dual parity) Data is striped on a block level across a set of drives, just like in RAID 5, and a second set of parity is calculated and written across all the drives; RAID 6 provides for an extremely high data fault tolerance and can sustain two simultaneous drive failures.

This is a perfect solution for mission critical applications.

RAID 10

RAID 10 is implemented as a striped array whose segments are RAID 1 arrays. RAID 10 has the same fault tolerance as RAID level 1. RAID 10 has the same overhead for fault-tolerance as mirroring alone. High I/O rates are achieved by striping RAID 1 segments. Under certain circumstances, RAID 10 array can sustain up to 2 simultaneous drive failures

Excellent solution for applications that would have otherwise gone with RAID 1 but need an additional performance boost.

RAID 50

A RAID 50 combines the straight block-level striping of RAID 0 with the distributed parity of RAID 5. This is a RAID 0 array striped across RAID 5 elements. It requires at least 6 drives.

RAID 60

A RAID 60 combines the straight block-level striping of RAID 0 with the distributed double parity of RAID 6. That is, a RAID 0 array striped across RAID 6 elements. It requires at least 8 disks.

JBOD

Although a concatenation of disks (also called JBOD, or "Just a Bunch of Disks") is not one of the numbered RAID levels, it is a popular method for combining multiple physical disk drives into a single virtual one. As the name implies, disks are merely concatenated together, end to beginning, so they appear to be a single large disk.

As the data on JBOD is not protected, one drive failure could result total data loss.

Stripe Size

The length of the data segments being written across multiple hard disks. Data is written in stripes across the multiple hard disks of a RAID. Since multiple disks are accessed at the same time, disk striping enhances performance. The stripes can vary in size.

Disk Usage

When all disks are of the same size, and used in RAID, Thecus IP storage disk usage percentage is listed below:

RAID Level	Percentage Used
RAID 0	100%
RAID 1	$1/n \times 100\%$
RAID 5	$(n-1)/n \times 100\%$
RAID 6	$(n-2)/n \times 100\%$
RAID 10	50%
RAID 50	$(n-1)/n \times 100\%$
RAID 60	$(n-2)/n \times 100\%$
JBOD	100%

n : HDD number

Appendix C: Active Directory Basics

Overview

With Windows 2000, Microsoft introduced Active Directory (ADS), which is a large database/information store. Prior to Active Directory the Windows OS could not store additional information in its domain database. Active Directory also solved the problem of locating resources; which previously relied on Network Neighborhood, and was slow. Managing users and groups were among other issues Active Directory solved.

What is Active Directory?

Active Directory was built as a scalable, extensible directory service that was designed to meet corporate needs. A repository for storing user information, accounts, passwords, printers, computers, network information and other data, Microsoft calls Active Directory a "namespace" where names can be resolved.

ADS Benefits

ADS lets Thecus IP storage integrate itself with the existing ADS in an office environment. This means the Thecus IP storage is able to recognize your office users and passwords on the ADS server. Other major benefits ADS support provides include:

1. Easy integration of Thecus IP storage into the existing office IT infrastructure

The Thecus IP storage acts as a member of the ADS. This feature significantly lowers the overhead of the system administrator. For example, corporate security policies and user privileges on an ADS server can be enforced automatically on Thecus IP storage.

2. Centralized user/password database

The Thecus IP storage does not maintain its own copy of the user/password database. This avoids data inconsistency between Thecus IP storage and other servers. For example, without ADS support, an administrator might need to remove a specific user privilege on Thecus IP storage and each individual server. With ADS support, the change on an ADS server is known to all of its ADS members.

Appendix D: Licensing Information

Overview

This product included copyrighted third-party software licensed under the terms of GNU General Public License. Please see THE GNU General Public License for extra terms and conditions of this license.

Source Code Availability

Thecus Technology Corp. has exposed the full source code of the GPL licensed software. For more information on how you can obtain our source code, please visit our web site, <http://www.thecus.com>.

Copyrights

- This product includes cryptographic software written by Eric Young (eay@cryptsoft.com).
- This product includes software developed by Mark Murray.
- This product includes software developed by Eric Young (eay@cryptsoft.com).
- This product includes software developed by the OpenSSL Project for use in the OpenSSL Toolkit (<http://www.openssl.org/>).
- This product includes PHP, freely available from (<http://www.php.net/>).
- This product includes software developed by the University of California, Berkeley and its contributors.
- This product includes software developed by Winning Strategies, Inc.
- This product includes software developed by the Apache Group for use in the Apache HTTP server project (<http://www.apache.org/>).
- This product includes software developed by Softweyr LLC, the University of California, Berkeley, and its contributors.
- This product includes software developed by Bodo Moeller.
- This product includes software developed by Greg Roelofs and contributors for the book, "PNG: The Definitive Guide," published by O'Reilly and Associates.
- This product includes software developed by the NetBSD Foundation, Inc. and its contributors.
- This product includes software developed by Yen Yen Lim and North Dakota State University.
- This product includes software developed by the Computer Systems Engineering Group at Lawrence Berkeley Laboratory.
- This product includes software developed by the Kungliga Tekniska Högskolan and its contributors.
- This product includes software developed by the Nick Simicich.
- This product includes software written by Tim Hudson (tjh@cryptsoft.com).
- This product includes software developed by Christopher G. Demetriou for the NetBSD Project.

CGIC License Terms

Basic License

CGIC, copyright 1996, 1997, 1998, 1999, 2000, 2001, 2002, 2003, 2004 by Thomas Boutell and Boutell.Com, Inc.

Permission is granted to use CGIC in any application, commercial or noncommercial, at no cost. HOWEVER, this copyright paragraph must appear on a "credits" page accessible in the public online and offline documentation of the program. Modified versions of the CGIC library should not be distributed without the attachment of a clear statement regarding the author of the modifications, and this notice may in no case be removed. Modifications may also be submitted to the author for inclusion in the main CGIC distribution.

GNU General Public License

Version 2, June 1991

Copyright © 1989, 1991 Free Software Foundation, Inc.
51 Franklin St, Fifth Floor, Boston, MA 02110-1301 USA

Everyone is permitted to copy and distribute verbatim copies of this license document, but changing it is not allowed.

PREAMBLE

The licenses for most software are designed to take away your freedom to share and change it. By contrast, the GNU General Public License is intended to guarantee your freedom to share and change free software--to make sure the software is free for all its users. This General Public License applies to most of the Free Software Foundation's software and to any other program whose authors commit to using it. (Some other Free Software Foundation software is covered by the GNU Library General Public License instead.) You can apply it to your programs, too.

When we speak of free software, we are referring to freedom, not price. Our General Public Licenses are designed to make sure that you have the freedom to distribute copies of free software (and charge for this service if you wish), that you receive source code or can get it if you want it, that you can change the software or use pieces of it in new free programs; and that you know you can do these things.

To protect your rights, we need to make restrictions that forbid anyone to deny you these rights or to ask you to surrender the rights. These restrictions translate to certain responsibilities for you if you distribute copies of the software, or if you modify it.

For example, if you distribute copies of such a program, whether gratis or for a fee, you must give the recipients all the rights that you have. You must make sure that they, too, receive or can get the source code. And you must show them these terms so they know their rights.

We protect your rights with two steps: (1) copyright the software, and (2) offer you this license which gives you legal permission to copy, distribute and/or modify the software.

Also, for each author's protection and ours, we want to make certain that everyone understands that there is no warranty for this free software. If the software is modified by someone else and passed on, we want its recipients to know that what

they have is not the original, so that any problems introduced by others will not reflect on the original authors' reputations.

Finally, any free program is threatened constantly by software patents. We wish to avoid the danger that redistributors of a free program will individually obtain patent licenses, in effect making the program proprietary. To prevent this, we have made it clear that any patent must be licensed for everyone's free use or not licensed at all.

The precise terms and conditions for copying, distribution and modification follow.

TERMS AND CONDITIONS FOR COPYING, DISTRIBUTION AND MODIFICATION

0. This License applies to any program or other work which contains a notice placed by the copyright holder saying it may be distributed under the terms of this General Public License. The "Program", below, refers to any such program or work, and a "work based on the Program" means either the Program or any derivative work under copyright law: that is to say, a work containing the Program or a portion of it, either verbatim or with modifications and/or translated into another Language. (Hereinafter, translation is included without limitation in the term "modification".) Each licensee is addressed as "you".

Activities other than copying, distribution and modification are not covered by this License; they are outside its scope. The act of running the Program is not restricted, and the output from the Program is covered only if its contents constitute a work based on the Program (independent of having been made by running the Program).

Whether that is true depends on what the Program does.

1. You may copy and distribute verbatim copies of the Program's source code as you receive it, in any medium, provided that you conspicuously and appropriately publish on each copy an appropriate copyright notice and disclaimer of warranty; keep intact all the notices that refer to this License and to the absence of any warranty; and give any other recipients of the Program a copy of this License along with the Program.

You may charge a fee for the physical act of transferring a copy, and you may at your option offer warranty protection in exchange for a fee.

2. You may modify your copy or copies of the Program or any portion of it, thus forming a work based on the Program, and copy and distribute such modifications or work under the terms of Section 1 above, provided that you also meet all of these conditions:
 - a) You must cause the modified files to carry prominent notices stating that you changed the files and the date of any change.
 - b) You must cause any work that you distribute or publish, that in whole or in part contains or is derived from the Program or any part thereof, to be licensed as a whole at no charge to all third parties under the terms of this License.
 - c) If the modified program normally reads commands interactively when run, you must cause it, when started running for such interactive use in the most ordinary way, to print or display an announcement including an appropriate copyright notice and a notice that there is no warranty (or else, saying that you provide a warranty) and that users may redistribute the program under

these conditions, and telling the user how to view a copy of this License. (Exception: if the Program itself is interactive but does not normally print such an announcement, your work based on the Program is not required to print an announcement.)

These requirements apply to the modified work as a whole. If identifiable sections of that work are not derived from the Program, and can be reasonably considered independent and separate works in themselves, then this License, and its terms, do not apply to those sections when you distribute them as separate works. But when you distribute the same sections as part of a whole which is a work based on the Program, the distribution of the whole must be on the terms of this License, whose permissions for other licensees extend to the entire whole, and thus to each and every part regardless of who wrote it.

Thus, it is not the intent of this section to claim rights or contest your rights to work written entirely by you; rather, the intent is to exercise the right to control the distribution of derivative or collective works based on the Program.

In addition, mere aggregation of another work not based on the Program with the Program (or with a work based on the Program) on a volume of a storage or distribution medium does not bring the other work under the scope of this License.

3. You may copy and distribute the Program (or a work based on it, under Section 2) in object code or executable form under the terms of Sections 1 and 2 above provided that you also do one of the following:
 - a) Accompany it with the complete corresponding machine-readable source code, which must be distributed under the terms of Sections 1 and 2 above on a medium customarily used for software interchange; or,
 - b) Accompany it with a written offer, valid for at least three years, to give any third party, for a charge no more than your cost of physically performing source distribution, a complete machine-readable copy of the corresponding source code, to be distributed under the terms of Sections 1 and 2 above on a medium customarily used for software interchange; or,
 - c) Accompany it with the information you received as to the offer to distribute corresponding source code. (This alternative is allowed only for noncommercial distribution and only if you received the program in object code or executable form with such an offer, in accord with Subsection b above.)

The source code for a work means the preferred form of the work for making modifications to it. For an executable work, complete source code means all the source code for all modules it contains, plus any associated interface definition files, plus the scripts used to control compilation and installation of the executable. However, as a special exception, the source code distributed need not include anything that is normally distributed (in either source or binary form) with the major components (compiler, kernel, and so on) of the operating system on which the executable runs, unless that component itself accompanies the executable.

If distribution of executable or object code is made by offering access to copy from a designated place, then offering equivalent access to copy the source code from the same place counts as distribution of the source code, even though third parties are not compelled to copy the source along with the object code.

4. You may not copy, modify, sublicense, or distribute the Program except as expressly provided under this License. Any attempt otherwise to copy, modify, sublicense or distribute the Program is void, and will automatically terminate your rights under this License. However, parties who have received copies, or rights, from you under this License will not have their licenses terminated so long as such parties remain in full compliance.
5. You are not required to accept this License, since you have not signed it. However, nothing else grants you permission to modify or distribute the Program or its derivative works. These actions are prohibited by law if you do not accept this License. Therefore, by modifying or distributing the Program (or any work based on the Program), you indicate your acceptance of this License to do so, and all its terms and conditions for copying, distributing or modifying the Program or works based on it.
6. Each time you redistribute the Program (or any work based on the Program), the recipient automatically receives a license from the original licensor to copy, distribute or modify the Program subject to these terms and conditions. You may not impose any further restrictions on the recipients' exercise of the rights granted herein. You are not responsible for enforcing compliance by third parties to this License.
7. If, as a consequence of a court judgment or allegation of patent infringement or for any other reason (not limited to patent issues), conditions are imposed on you (whether by court order, agreement or otherwise) that contradict the conditions of this License, they do not excuse you from the conditions of this License. If you cannot distribute so as to satisfy simultaneously your obligations under this License and any other pertinent obligations, then as a consequence you may not distribute the Program at all. For example, if a patent license would not permit royalty-free redistribution of the Program by all those who receive copies directly or indirectly through you, then the only way you could satisfy both it and this License would be to refrain entirely from distribution of the Program.

If any portion of this section is held invalid or unenforceable under any particular circumstance, the balance of the section is intended to apply and the section as a whole is intended to apply in other circumstances.

It is not the purpose of this section to induce you to infringe any patents or other property right claims or to contest validity of any such claims; this section has the sole purpose of protecting the integrity of the free software distribution system, which is implemented by public license practices. Many people have made generous contributions to the wide range of software distributed through that system in reliance on consistent application of that system; it is up to the author/donor to decide if he or she is willing to distribute software through any other system and a licensee cannot impose that choice.

This section is intended to make thoroughly clear what is believed to be a consequence of the rest of this License.

8. If the distribution and/or use of the Program is restricted in certain countries either by patents or by copyrighted interfaces, the original copyright holder who places the Program under this License may add an explicit geographical distribution limitation excluding those countries, so that distribution is permitted only in or among countries not thus excluded. In such case, this License incorporates the limitation as if written in the body of this License.

9. The Free Software Foundation may publish revised and/or new versions of the General Public License from time to time. Such new versions will be similar in spirit to the present version, but may differ in detail to address new problems or concerns.

Each version is given a distinguishing version number. If the Program specifies a version number of this License which applies to it and "any later version", you have the option of following the terms and conditions either of that version or of any later version published by the Free Software Foundation. If the Program does not specify a version number of this License, you may choose any version ever published by the Free Software Foundation.

10. If you wish to incorporate parts of the Program into other free programs whose distribution conditions are different, write to the author to ask for permission. For software which is copyrighted by the Free Software Foundation, write to the Free Software Foundation; we sometimes make exceptions for this. Our decision will be guided by the two goals of preserving the free status of all derivatives of our free software and of promoting the sharing and reuse of software generally.

NO WARRANTY

11. BECAUSE THE PROGRAM IS LICENSED FREE OF CHARGE, THERE IS NO WARRANTY FOR THE PROGRAM, TO THE EXTENT PERMITTED BY APPLICABLE LAW. EXCEPT WHEN OTHERWISE STATED IN WRITING THE COPYRIGHT HOLDERS AND/OR OTHER PARTIES PROVIDE THE PROGRAM "AS IS" WITHOUT WARRANTY OF ANY KIND, EITHER EXPRESSED OR IMPLIED, INCLUDING, BUT NOT LIMITED TO, THE IMPLIED WARRANTIES OF MERCHANTABILITY AND FITNESS FOR A PARTICULAR PURPOSE. THE ENTIRE RISK AS TO THE QUALITY AND PERFORMANCE OF THE PROGRAM IS WITH YOU. SHOULD THE PROGRAM PROVE DEFECTIVE, YOU ASSUME THE COST OF ALL NECESSARY SERVICING, REPAIR OR CORRECTION.
12. IN NO EVENT UNLESS REQUIRED BY APPLICABLE LAW OR AGREED TO IN WRITING WILL ANY COPYRIGHT HOLDER, OR ANY OTHER PARTY WHO MAY MODIFY AND/OR REDISTRIBUTE THE PROGRAM AS PERMITTED ABOVE, BE LIABLE TO YOU FOR DAMAGES, INCLUDING ANY GENERAL, SPECIAL, INCIDENTAL OR CONSEQUENTIAL DAMAGES ARISING OUT OF THE USE OR INABILITY TO USE THE PROGRAM (INCLUDING BUT NOT LIMITED TO LOSS OF DATA OR DATA BEING RENDERED INACCURATE OR LOSSES SUSTAINED BY YOU OR THIRD PARTIES OR A FAILURE OF THE PROGRAM TO OPERATE WITH ANY OTHER PROGRAMS), EVEN IF SUCH HOLDER OR OTHER PARTY HAS BEEN ADVISED OF THE POSSIBILITY OF SUCH DAMAGES.

END OF TERMS AND CONDITIONS