W6-LI Pentium Pro
PCI/ISA
System Board Manual

MICRONICS

Document Number: 06-00288-03, Rev. 1B

May 1997

45365 Northport Loop West, Fremont, CA 94538

Copyright Notices

Copyright © 1996, 1997 Micronics Computers, Inc. The information contained in the W6-LI PCI/ISA Dual Pentium Pro Processor system board manual has been carefully checked and is believed to be accurate. Micronics assumes no responsibility for any inaccuracies that may be contained in this document. Micronics makes no commitments to update or to keep the information in this manual at a current level when changes are made to the product.

Micronics reserves the right to make improvements to this document and/or product at any time and without notice. All Rights Reserved. No part of this document may be photocopied, reproduced, translated, or reduced to any medium or machine form without prior, written consent from Micronics.

Portions of the Manual

Portions of this manual were copied (with permission) from Phoenix Technologies, Ltd., Adaptec, Inc. and Micro Computer Systems, Inc. All rights reserved.

Trademarks

IBM is a registered trademark of International Business Machines. Microsoft and Windows are registered trademarks of Microsoft Corporation. Intel and PCI are registered trademarks of Intel Corporation. All other product names mentioned herein are used for identification purposes only and may be the trademarks of their respective companies.

Table of Contents

Introduction	5
Features	6
Software Compatibility	7
Before You Begin	8
Chapter 1 - Quick Installation	9
Installing the W6-LI	9
Chapter 2 - Configuring the W6-LI	11
Static Electricity	11
Office Environment	11
W6-LI System Board	12
W6-LI Back Panel Connections	12
Jumper Settings	13
Chapter 3 - Installing the W6-LI	17
Introduction	17
System Memory Support	17
Installing the W6-LI	18
Tools Required	18
Equipment Required	18
System Memory	19
DIMMs Supported	19
Adding Memory	19
Memory Configurations	21
Installing the DIMMs	25
Removing DIMMs	25
Installing a CPU	26
Installing a PCI Peripheral Card	27
Installing a ISA Peripheral Card	28

Installing a CD-ROM Drive	29
The W6-LI Sound Option	30
Connecting Sound Devices	30
Connecting the Telephony Option	31
Connecting the SCSI Option	32
Chapter 4 - The BIOS Setup Utility	33
Configuration	33
Initial Bootup	33
Setup	33
Running the Setup Procedure	35
Setting the Main Screen	35
Setting the Advanced Screen	40
Security Screen	43
Power Screen	46
Boot Screen	48
Exit Screen	49
Chapter 5 - Installing Device Drivers	51
About Device Drivers	51
Installing the Sound Drivers	51
Installing the SCSI Drivers	52
Appendix A - Technical Information	53
Specifications	53
Environmental Specifications	54
Temperature Range	54
Relative Humidity	54
Battery Disposal	55
Support and Information Services	56
Technical Support	56

Appendix B - Post Messages	59
Appendix C - Beep and POST Codes	61
Appendix D - Hard Disk Drive Types	65
Appendix E - Updating the System BIOS	67
Appendix F - Warranties and Notices	69
Limited Warranty	69
FCC Statement	71
Declaration of Conformity	72
Glossary	73
Index	77

List of Figures

Figure 1.1: Power-Up Screen	10
Figure 2.1: W6-LI System Board	12
Figure 2.2: W6-LI Back Panel Connections	12
Figure 3.1: Installing a 168-Pin DIMM	25
Figure 3.2: Installing a PCI Card	27
Figure 3.3: Installing an ISA Peripheral Card	28
Figure 3.4: Connecting External Sound Devices	30
Figure 4.1: Power-Up Screen	34
Figure 4.2: CMOS Main Screen	35
Figure 4.3: IDE Device Submenu	38
Figure 4.4: Advanced Screen	40
Figure 4.5: Security Screen	43
Figure 4.6: Supervisor Password Submenu	44
Figure 4.7: Power Screen	46
Figure 4.8: Boot Screen	48
Figure 4.9: Exit Screen	49

List of Tables

Table 2.1: CPU Speed Selection	13
Table 2.2: CPU Voltage Selection	13
Table 2.3: ISA Bus Clock Selection	14
Table 2.4: System Power Supply Setting	14
Table 2.5: Clear CMOS Settings	14
Table 2.6: Onboard Sound Selection	14
Table 2.7: Pipelining Mode Settings	15
Table 2.8: Onboard SCSI Selection	15
Table 2.9: Case and Peripheral Connections	15
Table 3.1: Memory Configurations	21
Table A.1: Support and Information Services	57

Introduction

Thank you for choosing the W6-LI system board. The W6-LI is the highest performing advanced dual processor solution for the industry's most demanding workstation and server applications.

Based on the Intel 440FX PCIset, the W6-LI supports the most advanced processor architecture, the Pentium Pro®, which provides the speed and performance necessary to address the most intensive computational applications. Integrated Ultra Wide SCSI (up to 40MBytes/sec transfer rate), PCI and ISA slots, up to 512K of Level 2 cache on each CPU and support of Universal Serial Bus (USB), make this board powerful and feature rich.

The USB interface has a maximum bandwidth of 12Mbps and can connect as many as 127 devices to a host system. USB supports both standard devices that operate at the full 12Mbps rate and low-end devices that use only a 1.5Mbps subchannel.

Designed to fit into the most modern ATX form factor, the flexible W6-LI also features support for Fast Page Mode (FPM) and Extended Data Out (EDO) DRAM advanced memory, and Error Checking and Correction (ECC). The ATX form factor allows critical components such as floppy drive connectors, chassis fan, CPU and memory to be strategically located so that full length cards can be used in all slots.

Micronics builds all products to exacting standards, using the highest quality components available. We are proud to provide this system board and believe you will be pleased with your purchase.

Features

The W6-LI includes the following features:

- ▲ Dual ZIF Socket 8
Intel Pentium® Pro 150, 166, 180 and 200MHz processors
One integrated VRM and one VRM header to supply CPU-specific voltages
- ▲ Intel 440FX PCIset
Intel PIIX 3
SMC FDC37C93X Ultra I/O chip
- ▲ Four 32-bit PCI slots
Two 16-bit ISA slots
(One is a shared PCI/ISA slot)
- ▲ Maximum memory - 512MB
Four 3.3V buffered 168-pin DIMM sockets
- ▲ Supports FPM and EDO DRAM memory
ECC support via chipset when using parity DIMMs
- ▲ Fast SCSI Bus Mastering controller, 50 pin SCSI connector, 68 pin SCSI connector (Ultra Wide), EZ-SCSI Drivers (optional)
- ▲ Creative Labs VIBRA 16CL Sound (optional)
- ▲ Two Universal Serial Bus (USB) ports for desktop peripheral expansion (optional)

Software Compatibility

The W6-LI system board has been thoroughly tested for compatibility with a variety of operating systems and environments, including:

- ▲ Microsoft
 - DOS 5.0
 - DOS 6.2
 - Windows 95
 - Windows NT 3.51
 - Windows NT 4.0
- ▲ IBM
 - OS/2 Warp 3.0
 - OS/2 Warp 4.0
- ▲ SCO
 - UNIXWare 2.1.1
 - Open Server 5.02
 - UNIX 3.2, 4.2
- ▲ Novell NetWare 3.12
 - Novell NetWare 4.11

Before You Begin

This manual will familiarize you with the features, installation and use of your W6-LI. There are several symbols and conventions used throughout this manual to help draw your attention to a feature or to focus on important information:



When you see the Magnifying Glass, it refers to something you should take a closer look at before proceeding further.



When you see the Exclamation Mark, it gives important information on avoiding damage.

Common Names

DIMM	Dual Inline Memory Module
DRAM	Dynamic Random Access Memory
ECC	Error Checking and Correction
EDO	Extended Data Out
FPM	Fast Page Mode
IDE	Integrated Drive Electronics
PCI	Peripheral Component Interconnect
USB	Universal Serial Bus
VRM	Voltage Regulator Module

Chapter

1

Quick Installation

We know that many experienced people prefer to read as little of the documentation as possible. If this sounds like you, here's the short form to get up and running quickly.



STATIC!

Before handling the W6-LI, be properly grounded by using a special wrist or ankle strap, or touch a safely grounded object.

Installing the W6-LI

1. Make backup copies of your installation and configuration diskettes.
2. Ground yourself to prevent damaging static discharge, then remove the W6-LI from its packaging.
3. Configure and verify the system board's jumper settings (refer to Jumper Settings in Chapter 2).
4. Install the CPU and the system memory (refer to Chapter 3).
5. Install the system board into the chassis and make all necessary case connections.
6. Install any ISA and/or PCI add-on peripherals (refer to Chapter 3).
7. Now you can connect any optional devices (refer to Chapter 3).
8. Turn the computer on and press the <F2> key when you see the screen in Figure 1.1.

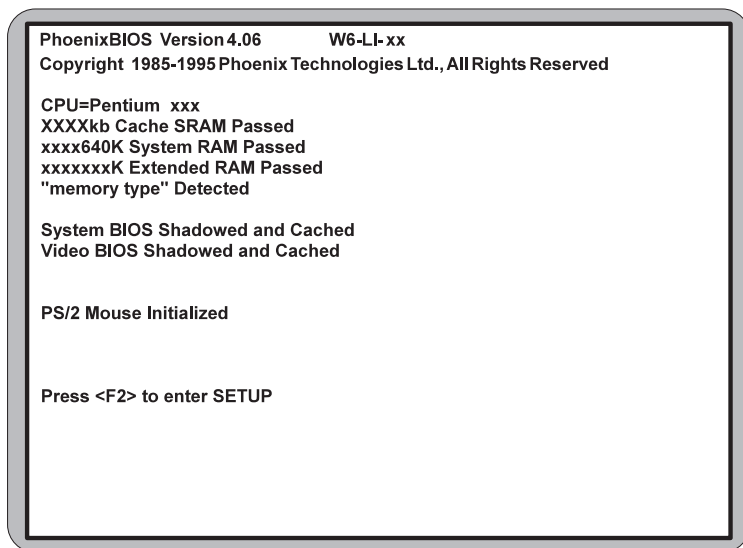

Figure 1-1: Power-Up Screen

9. Set the time and date. Adjust the BIOS settings to match your configuration. If installing an IDE drive, select the IDE device you wish to configure. Press ENTER with Autotype Fixed Disk selected and the BIOS will automatically configure the drive for you (refer to Chapter 4).
10. After you have configured the Main Setup menu, make any desired setting configurations in the Advanced and Security menu. When finished, go to the exit screen, select "Save Changes and Exit" and you are finished with the BIOS configuration (see Chapter 4).
11. Install your IDE CD-ROM drive and its device drivers (optional). Refer to Chapter 3.
12. Install the sound controller device drivers (optional). Refer to Chapter 5.
13. Install the SCSI device drivers (optional). Refer to Chapter 5.

Configuring the W6-LI

Although the W6-LI system board is packaged in protective materials, it is important to use care while unpacking and setting up.

Static Electricity

The W6-LI is shipped from the factory in an antistatic bag. To reduce the possibility of damage, it is important to neutralize any accumulated static charges on your body before handling the board. The best way to do this is to ground yourself using a special wrist or ankle strap. If you do not have a strap, you should touch both of your hands to a safely grounded object. After you have grounded yourself, ground the W6-LI via the solder pads surrounding one of its mounting holes.

Once the W6-LI is removed from its packaging, place it on top of the antistatic bag. Carefully inspect the board for damage which may have occurred during shipment.

Environment Considerations

Make sure the finished computer system is in an area with good ventilation. The system should not be in direct sunlight, near heaters, or exposed to moisture, dust or dirt.

W6-LI System Board

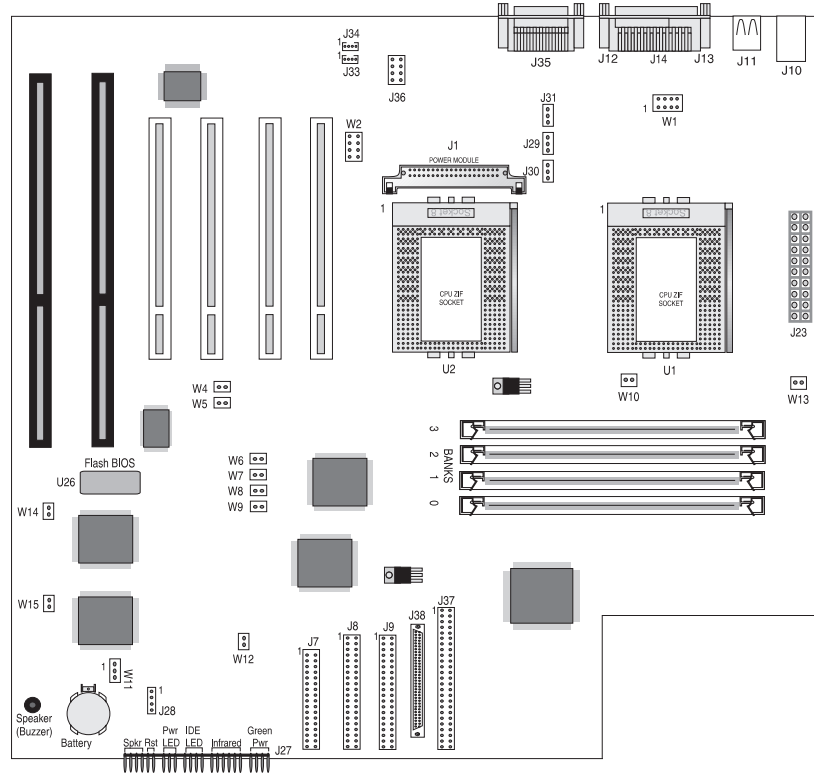

Figure 2-1: W6-LI System Board

W6-LI Back Panel Connections

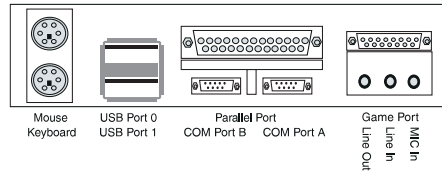

Figure 2-2: W6-LI Back Panel

Jumper Settings

This chapter gives you the jumper settings used for the W6-LI system board.

Table 2-1 lists the jumper settings to select the CPU frequency. These settings apply to both CPUs. *NOTE: Before making your selection, verify that jumper W12 is closed.*

CPU Speed	Bus Speed	W4	W5	W6	W7	W8	W9
150 MHz	60 x 2.5	Close	Open	Close	Close	Close	Open
166 MHz	66 x 2.5	Open	Close	Close	Close	Close	Open
180 MHz	60 x 3.0	Close	Open	Close	Close	Open	Close
200 MHz	66 x 3.0	Open	Close	Close	Close	Open	Close

Table 2-1: CPU Speed Selections

Table 2-2 lists the jumper settings for the CPU Voltage Identification (VID). The power regulators on the system board (one for each CPU) are capable of generating different voltages. VID is a hardware mechanism used by each CPU to tell its power regulator what voltage to set.

*NOTE: If the CPU supports VID, all jumpers on W1 and/or W2 must be removed or **damage may occur**. W1 is for the Primary CPU and W2 is for the secondary CPU.*

CPU Voltage	Jumpers W1 and W2			
	1-2	3-4	5-6	7-8
VID-Enabled (default)	Open	Open	Open	Open
Non-VID 2.9V	Close	Open	Open	Close
Non-VID 3.1V	Close	Open	Close	Close
Non-VID 3.3V	Close	Close	Open	Close

Table 2-2: CPU Voltage Selection

Chapter 2: Configuring the W6-LI

Table 2-3 lists the jumper settings for the ISA Bus clock frequency.

Jumper	Host Bus Speed	ISA Bus Speed	Setting
W12	60MHz (default)	7.50MHz	Close
	66MHz (default)	8.25MHz	Close

Table 2-3: ISA BUS Clock Settings

Table 2-4 lists the jumper settings to enable or disable the system power supply.

Jumper	Function	Settings
W13	Normal (default)	Open
	Reserved	Close

Table 2-4: System Power Supply Setting

Table 2-5 lists the jumper settings to clear the CMOS settings. With your computer's power off, close pins 2-3, wait ten seconds and place the jumper back on pins 1-2. (The jumper must be placed back on pins 1-2 for the system to function properly.)

NOTE: This will reset all BIOS default settings. Any changes you have made will be lost.

Jumper	Function	Settings
W11	Normal (default)	1-2
	Clear CMOS	2-3

Table 2-5: Clear CMOS Settings

Table 2-6 lists the jumper settings to select the optional onboard sound.

Jumper	Function	Settings
W14	Enable Sound (default)	Close
	Disable Sound	Open

Table 2-6: Onboard Sound Selection

Table 2-7 lists the jumper settings for the Host Bus Agents pipelining mode. Host Bus Agents are devices connected to the CPU local bus, which include the CPUs and the 440FX chipset. Host Bus Agents can generate, up to eight at a time, multiple overlapped (or pipelined) bus transactions (or bus cycles).

Jumper	Function	Settings
W10	Normal (default)	Open
	Reserved	Close

Table 2-7: Pipelining Mode Settings

Table 2-8 lists the jumper settings to select the optional onboard SCSI.

Jumper	Function	Settings
W15	Enable SCSI (default)	Close
	Disable SCSI	Open

Table 2-8: Onboard SCSI Selection

Table 2-9 lists the jumpers for the case and peripheral connections.

Connector	Function	Notes
J1	Voltage Regulator Module	For Secondary CPU
J3-J6	DRAM (168-pin DIMM sockets)	3.3 Volt Only. Buffered DIMMs Supported
J7	Floppy Drive Connector	Supports up to two floppy drives
J8	Primary IDE Port Connector	Supports up to two IDE devices
J9	Secondary IDE Port Connector	Supports up to two IDE devices
J10	PS/2 Keyboard Connector PS/2 Mouse Connector	Lower Level Upper Level
J11	USB Connector (optional)	Lower Level: USB Port 1 Upper Level: USB Port 0
J12	Serial Port A Connector	
J13	Serial Port B Connector	
J14	Parallel Port Connector	Upper Level
J15-J18	PCI Bus Expansion Slots	

Table 2-9A: Case & Peripheral Connections

Chapter 2: Configuring the W6-LI

Connector	Function	Notes
J19-J20	ISA Bus Expansion Slots	
J23	Power Supply Connector	ATX Standard
J27	Front I/O Connector	
"	System Power On/Off	1 - Power; 2 - Ground
"	Reset Switch	23 - Reset; 22 - Ground
"	PC Speaker Note: Jumper pins 26 and 27 to use the onboard speaker	27 - Speaker; 24 - +5V DC
"	Power-On LED	20 - Positive; 18 - Ground
"	IDE LED Note: IDE and SCSI functions share the same LED	13 or 16 - Positive; 15 - Negative
"	Infrared	6 - +5V DC; 8 - Receive Data; 9 - Ground; 10 - Transmit Data
"	Speaker (Buzzer) Note: Jumper pins 26 and 27 to use the onboard speaker	Enabled (default)
J28	Infrared Port Connector (Note: Do not connect IR devices to J27 & J28 simultaneously)	1 - Receive Data; 2 - Ground; 3 - Transmit Data; 4 - +5V Power
J29, J30	CPU Fan (J29 - Primary) (J30 - Secondary)	1 - 12+V Power; 2 - Ground; 3 - Status (Running or Stopped)
J31	Chassis Fan	1 - 12+V Power; 2 - Ground; 3 - Status (Running or Stopped)
J33	CD-ROM Audio Input	1 - Ground; 2 - CD-In Left Channel; 3 - Ground; 4 - CD-In Right Channel
J34	Modem/Telephony	1 - No Connect; 2 - MIC Out; 3 - Ground; 4 - Speaker Input
J35	Game Port/MIDI MIC In Line In Line Out	Upper Level Lower Level Lower Level Lower Level
J36	Wavetable Upgrade	1 - Right Channel Input; 2 - Ground; 3 - Left Channel Input; 4 - Ground; 5 - No Connect; 6 - Ground; 7 - Ground; 8 - Ground
J37	SCSI 50-pin Cable Connector	Fast SCSI (optional)
J38	SCSI 68-pin Cable Connector	Ultra Wide SCSI (optional)
U1	Primary P6 CPU	Socket 8 (387-pin)
U2	Secondary P6 CPU	Socket 8 (387-pin)
U25	System BIOS	

Table 2-9B: Case & Peripheral Connections (cont.)

Installing the W6-LI

Introduction

This chapter explains how to install the W6-LI system board, memory, CPU and peripherals.

WARNING: *Before installing or removing any peripherals or components, make sure you have a clear work space and that you adhere to all anti-static precautions described in Chapter 1. Micronics recommends only trained technicians install and configure the system board.*

Damage which occurs to the board while adding or removing peripherals or components may void the warranty. If problems arise while installing peripherals, contact the computer dealer where you purchased the peripheral or Micronics' Technical Support Department.

System Memory Support

The flexibility of the W6-LI is augmented by its support for Error Checking and Correction (ECC), Extended Data Out (EDO) and Fast Page Mode (FPM) DRAM memory. The W6-LI supports Error Checking and Correction (with 72-bit DIMMs only) via the chipset.

EDO memory is designed to keep data available to the processor for an extended period of time. The EDO memory support extends the performance of conventional DRAM memory. The result is an improvement in memory-access performance on the W6-LI system board.

Installing the W6-LI

Installation of the W6-LI system board depends on the type of case you use. The W6-LI is designed for the standard ATX form factor and must be installed in an ATX chassis.

NOTE: If you are unfamiliar with installing a system board, Micronics highly recommends that you read the computer user's manual or contact your dealer's technical support department.

Tools Required

Micronics recommends using the following tools to install the W6-LI:

- Small Phillips screwdriver
- Tweezers or a pair of needle-nose pliers
- Tray (to hold loose screws)

Equipment Required

Micronics recommends using the following equipment with the W6-LI for a typical configuration:

- ATX chassis with standard hardware.
- A high-quality ATX power supply capable of providing continuous power within a 3 volt range. A power filter may be used with a noisy AC power source.
- PS/2 mouse and compatible keyboard.
- Eight ohm speaker.
- Standard ribbon cables for internal connections.
- Standard power cord (grounded).
- Heat sink with cooling fan for each CPU (required).

System Memory

System memory is necessary to operate the W6-LI system board. The W6-LI uses DIMMs, which provide a wider data path than SIMMs, to carry more data.

The W6-LI has four 168-pin DIMM sockets for a maximum of 512 Megabytes of RAM. Support is provided for EDO DRAM memory and FPM DRAM memory. This chapter will explain the type of DIMMs supported, list the rules for adding memory to the W6-LI, give some examples of common memory configurations and show how to physically install the new DIMMs.



For long term reliability, Micronics recommends using DIMMs with gold-plated contacts. The use of tin-plated contacts may conflict with the gold alloy on the DIMM socket.

DIMMs Supported

The W6-LI supports the following types of 60 or 70ns DIMMs:

8MB (1Mx64/72)
16MB (2Mx64/72)
32MB (4Mx64/72)
64MB (8Mx64/72)*
128MB (16Mx64/72)*

*Subject to availability

Adding Memory

The following is a list of rules to follow when upgrading DIMMs. If you follow these rules, your upgrade should be trouble-free:

- Use 70ns or faster DIMMs.
- There are three (3) types of DIMM wiring configurations: Non-parity - 64 bits wide, Parity and Error Checking and Correction - 72-bits wide.
- All three types of DIMM configurations may be used on the W6-LI, but not simultaneously.

Chapter 3: Installing the W6-LI

- ❑ Upgrade DIMMs one bank at a time. Start with Bank 0, then work your way up (one DIMM per bank), adding memory from the smallest to the largest size.
- ❑ Install the two types of memory in separate banks. The memory will default to the speed of the slowest RAM installed.



There is no need to set any jumpers. When you reboot, the size and type of memory are automatically detected.

Memory Configurations

The following tables list the most common memory configurations. The memory available depends on the number of DIMMs installed.

Memory	Bank 0	Bank 1	Bank 2	Bank 3
8MB	1MBx64/72			
16MB	2MBx64/72			
16MB	1MBx64/72	1MBx64/72		
24MB	2MBx64/72	1MBx64/72		
24MB	1MBx64/72	1MBx64/72	1MBx64/72	
32MB	2MBx64/72	2MBx64/72		
32MB	2MBx64/72	1MBx64/72	1MBx64/72	
32MB	4MBx64/72			
32MB	1MBx64/72	1MBx64/72	1MBx64/72	1MBx64/72
40MB	2MBx64/72	2MBx64/72	1MBx64/72	
40MB	2MBx64/72	1MBx64/72	1MBx64/72	1MBx64/72
40MB	4MBx64/72	1MBx64/72		
48MB	2MBx64/72	2MBx64/72	2MBx64/72	
48MB	2MBx64/72	2MBx64/72	1MBx64/72	1MBx64/72
48MB	4MBx64/72	2MBx64/72		
48MB	4MBx64/72	1MBx64/72	1MBx64/72	
56MB	2MBx64/72	2MBx64/72	2MBx64/72	1MBx64/72
56MB	4MBx64/72	2MBx64/72	1MBx64/72	
56MB	4MBx64/72	1MBx64/72	1MBx64/72	1MBx64/72

Table 3-1: Memory Configurations

Chapter 3: Installing the W6-LI

Memory	Bank 0	Bank 1	Bank 2	Bank 3
64MB	2MBx64/72	2MBx64/72	2MBx64/72	2MBx64/72
64MB	4MBx64/72	2MBx64/72	2MBx64/72	
64MB	4MBx64/72	2MBx64/72	1MBx64/72	1MBx64/72
64MB	4MBx64/72	4MBx64/72		
64MB	8MBx64/72			
80MB	4MBx64/72	2MBx64/72	2MBx64/72	2MBx64/72
80MB	4MBx64/72	4MBx64/72	2MBx64/72	
80MB	4MBx64/72	4MBx64/72	1MBx64/72	1MBx64/72
80MB	8MBx64/72	2MBx64/72		
80MB	8MBx64/72	1MBx64/72	1MBx64/72	
96MB	4MBx64/72	4MBx64/72	2MBx64/72	2MBx64/72
96MB	4MBx64/72	4MBx64/72	4MBx64/72	
96MB	8MBx64/72	2MBx64/72	2MBx64/72	
96MB	8MBx64/72	2MBx64/72	1MBx64/72	1MBx64/72
96MB	8MBx64/72	4MBx64/72		
112MB	4MBx64/72	4MBx64/72	4MBx64/72	2MBx64/72
112MB	8MBx64/72	2MBx64/72	2MBx64/72	2MBx64/72
112MB	8MBx64/72	4MBx64/72	2MBx64/72	
112MB	8MBx64/72	4MBx64/72	1MBx64/72	1MBx64/72

Table 3-1: Memory Configurations

Memory	Bank 0	Bank 1	Bank 2	Bank 3
128MB	16MBx64/72			
128MB	4MBx64/72	4MBx64/72	4MBx64/72	4MBx64/72
128MB	8MBx64/72	4MBx64/72	2MBx64/72	2MBx64/72
128MB	8MBx64/72	4MBx64/72	4MBx64/72	
128MB	8MBx64/72	8MBx64/72		
160MB	16MBx64/72	2MBx64/72	2MBx64/72	
160MB	16MBx64/72	2MBx64/72	1MBx64/72	1MBx64/72
160MB	16MBx64/72	4MBx64/72		
160MB	8MBx64/72	4MBx64/72	4MBx64/72	4MBx64/72
160MB	8MBx64/72	8MBx64/72	2MBx64/72	2MBx64/72
160MB	8MBx64/72	8MBx64/72	4MBx64/72	
192MB	16MBx64/72	4MBx64/72	2MBx64/72	2MBx64/72
192MB	16MBx64/72	4MBx64/72	4MBx64/72	
192MB	16MBx64/72	8MBx64/72		
192MB	8MBx64/72	8MBx64/72	4MBx64/72	4MBx64/72
192MB	8MBx64/72	8MBx64/72	8MBx64/72	
224MB	16MBx64/72	4MBx64/72	4MBx64/72	4MBx64/72
224MB	16MBx64/72	8MBx64/72	2MBx64/72	2MBx64/72
224MB	16MBx64/72	8MBx64/72	4MBx64/72	
224MB	8MBx64/72	8MBx64/72	8MBx64/72	4MBx64/72

Table 3-1: Memory Configurations

Chapter 3: Installing the W6-LI

Memory	Bank 0	Bank 1	Bank 2	Bank 3
256MB	16MBx64/72	16MBx64/72		
256MB	16MBx64/72	8MBx64/72	4MBx64/72	4MBx64/72
256MB	16MBx64/72	8MBx64/72	8MBx64/72	
256MB	8MBx64/72	8MBx64/72	8MBx64/72	8MBx64/72
288MB	16MBx64/72	16MBx64/72	2MBx64/72	2MBx64/72
288MB	16MBx64/72	16MBx64/72	4MBx64/72	
288MB	16MBx64/72	8MBx64/72	8MBx64/72	4MBx64/72
320MB	16MBx64/72	16MBx64/72	4MBx64/72	4MBx64/72
320MB	16MBx64/72	16MBx64/72	8MBx64/72	
320MB	16MBx64/72	8MBx64/72	8MBx64/72	8MBx64/72
384MB	16MBx64/72	16MBx64/72	16MBx64/72	
384MB	16MBx64/72	16MBx64/72	8MBx64/72	8MBx64/72
448MB	16MBx64/72	16MBx64/72	16MBx64/72	8MBx64/72
512MB	16MBx64/72	16MBx64/72	16MBx64/72	16MBx64/72

Table 3-1: Memory Configurations

Installing the DIMMs

To install the DIMMs, locate the memory banks on the system board and perform the following steps:

1. Hold the DIMM so that the notched edge is aligned with the notch on the DIMM socket (Figure 3-1).
2. Insert the DIMM at a 90 degree angle.
3. Gently push the DIMM straight down until it locks into place (past the release tabs).

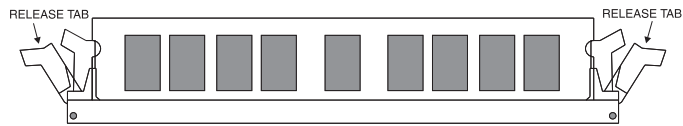

Figure 3-1: Installing a 168-Pin DIMM

Removing DIMMs

To remove DIMMs, follow the steps below:

1. With both thumbs (or fingers), press the release tabs away from the socket.
2. With the DIMM free from the release tabs, lift the module up and place in an anti-static bag or package.

Installing a CPU

The W6-LI is designed to support dual Pentium Pro processors. Follow the steps below to install the main or second processor:

1. Turn off the computer and remove its cover.
2. Locate the ZIF socket illustrated in Figure 2-1.
3. Lift the lever of the socket.
4. Locate pin 1 on the processor and pin 1 on the socket (refer to Figure 2-1). Gently place the processor into the socket, making sure pin 1 on the processor and pin 1 on the socket are aligned.
5. Push the lever down until it locks into place.
6. Make sure the speed and the voltage selection jumpers are set correctly (refer to Chapter 2 - Jumper Settings).
7. If you are installing a second processor, you do not need to change any jumpers or BIOS settings. The system will automatically recognize the new processor.

When installing a second processor, a VRM module must be installed into header J1. In addition, the second processor must have the same speed rating and cache amount as the main processor.

WARNING: *Pentium Pro processors require a heat-sink with a cooling fan. Failure to provide adequate cooling of the processor may seriously affect system performance or cause permanent damage to the processor.*

NOTE: *If your operating system supports dual processors, you may need to reconfigure or reinstall your operating system. Refer to your software documentation for more information.*

Installing a PCI Peripheral Card

Micronics PCI slots accommodate all PCI peripherals that meet the PCI 2.1 specifications. Follow the steps below to install a PCI card:

1. Turn the computer system off and remove its cover.
2. Choose an unused PCI slot and remove the slot cover.
3. Insert the card with the bottom edge level to the slot.
NOTE: Never insert the card at an angle.
4. Carefully push the card straight down, making sure the card is fully inserted.
5. Replace the screw which holds the card into place.
6. Replace the computer cover.
7. Refer to the PCI card's documentation additional instructions regarding installation and software drivers.

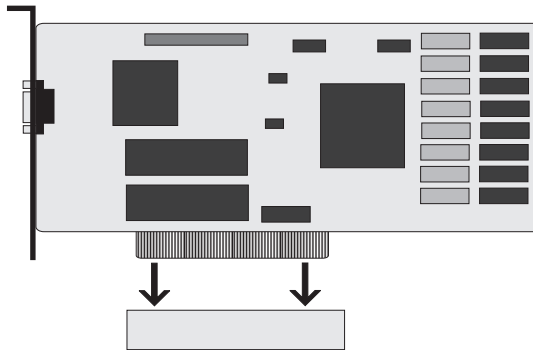

Figure 3-2: Installing a PCI Card

Installing an ISA Peripheral Card

Micronics ISA slots accommodate all standard ISA peripherals. Follow the steps below to install a PCI card:

1. Turn the computer system off and remove its cover.
2. Choose an unused ISA slot and remove the slot cover.
3. Insert the card with the bottom edge level to the slot.
NOTE: Never insert the card at an angle.
4. Carefully push the card straight down, making sure the card is inserted fully.
5. Replace the screw that holds the card into place.
6. Replace the computer cover.
7. Refer to the ISA card's documentation for additional instructions regarding installation and software drivers.

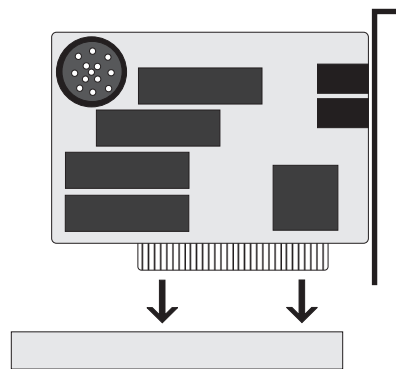

Figure 3-3: Installing an ISA Card

Installing a CD-ROM Drive

If you are installing a CD-ROM drive, Micronics recommends the installation of an IDE CD-ROM drive. *The instructions below will help you with the installation, but also refer to the documentation that accompanied your CD-ROM drive.*

Before starting the setup and installation, make sure your computer is off and the power cord is disconnected from the wall outlet. Your CD-ROM drive kit should contain the following items for a successful installation:

- CD-ROM Drive with installation hardware
 - Interface Cable
 - CD Audio Cable
1. Connect the ribbon cable as described in the CD-ROM's documentation, making sure the red stripe on the cable is aligned with pin 1 of the connectors.
 2. Connect the audio cable to the CD-ROM drive's audio connector.
 3. Connect the other end of the audio cable to the MPC-2 compatible CD-ROM audio connector on the W6-LI system board (see Figures 2.1 and 2.2).
 4. Connect the power supply cable to the CD-ROM drive's power connector.
 5. Install the CD-ROM device drivers. CD-ROM drives require device drivers to access the drive and are generally provided by the manufacturer of the CD-ROM drive. Usually one device driver is added to the CONFIG.SYS file and one to the AUTOEXEC.BAT file.
 6. If you are using the CD-ROM drive in an MS-DOS environment, the utility MSCDEX.EXE must also be added to the AUTOEXEC.BAT file. Consult your DOS manual for more information.

The W6-LI Sound Option

You can connect external sound devices to your W6-LI system board to take advantage of the optional sound support (refer to Figure 2.2). The sound option includes 16-bit stereo sound, a game and MIDI port and a telephony header. See Chapter 5 for information on installing sound device drivers.

Connecting Sound Devices

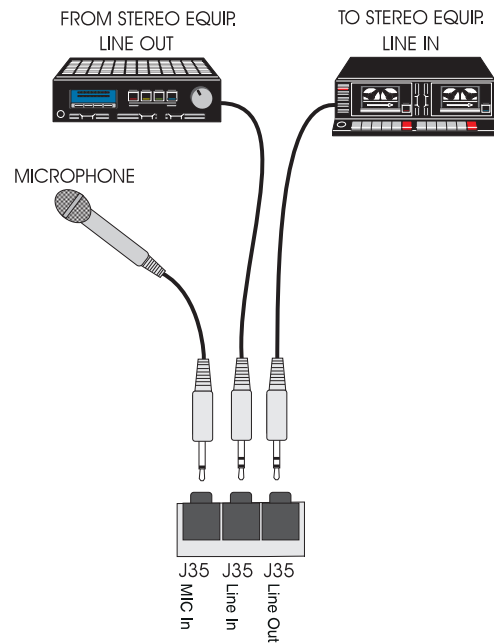

Figure 3-4: Connecting External Sound Devices

Game Port

You can use the Game Port connector to connect an IBM PC compatible joystick or MIDI instrument.

Line Out

The Line Out jack allows you to connect the audio output of the audio controller to your home stereo, VCR, or amplified speakers.

Line In

You may connect an external mono or stereo audio source to the audio controller, such as a tape player or radio. Use the appropriate converter cable to interface to your external equipment.

MIC IN

The MIC IN jack will accommodate a 300-600 ohm microphone.

Connecting the Telephony Option

The W6-LI system board can be upgraded to include a header for computer telephony (pronounced teh - leh' - fuh - nee) support. Telephony allows you to increase your communications productivity. You can integrate facsimile technology, sound and desktop video conferencing. The telephony option is enabled by connecting your modem cable to header J34.

Connecting the SCSI Option

The W6-LI can be upgraded to include integrated Ultra Wide SCSI PCI throughput (up to 40MBytes/sec data rate). Connectors are provided for Normal (Fast) SCSI (50-pin connector) and Wide (Ultra Wide) SCSI (68-pin connector). The Wide SCSI configuration allows up to 15 SCSI peripherals to be connected. The W6-LI SCSI interface is Plug and Play compliant and is fully compatible with the PCI 2.0 specification.

Refer to the "Adaptec AHA-2940Ultra/2940Ultra Wide User's Guide" for information on installing and connecting SCSI devices.

Configuration

After the W6-LI system board and all hardware is installed, the system is ready for configuration. Before turning on the computer, make sure all cables are correctly connected and all jumpers are correctly set.

It is recommended you keep the computer cover off the first time you boot the system. This will make it easier to correct any difficulties that might arise.

Initial Boot Up

Power up the W6-LI. If the system does not properly boot, check all your cables and peripherals for bad connections. You may also get beep codes or error messages. If this occurs, consult Appendices B and/or C for a guide to possible solutions.

After the system properly boots, it is ready to be configured. The following information explains the proper procedures for BIOS configuration.

Setup

The Setup program is used to configure the computer's BIOS (Basic Input/Output System). The computer's BIOS is responsible for configuring the system board and providing hardware information to the operating system. In order for the computer to run properly, run the Setup procedure after first installing the system board and whenever you make a hardware change to the system.

Chapter 4: The BIOS Setup Utility

After the system is turned on and goes through a memory test, the Power-Up screen (Figure 4-1) will appear on your monitor:

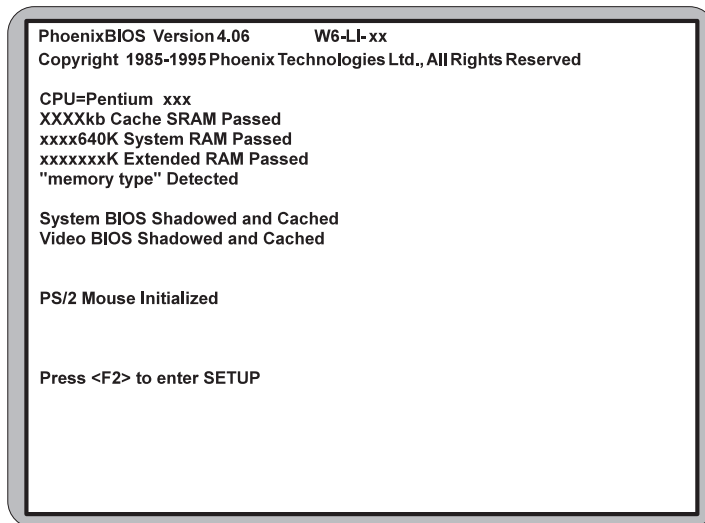

Figure 4-1: Power-Up Screen

When “Press <F2> to enter SETUP” appears at the bottom of the screen, press the <F2> key to begin the Setup procedure. The CMOS Main Screen (Figure 4-2) should appear and the prompt should be on the time line. The Setup procedure can only be activated during the boot sequence.

Running the Setup Procedure

The W6-LI system board has six primary CMOS configuration screens: Main Screen, Advanced Screen, Security Screen, Power Screen, Boot Screen and Exit Screen. To toggle between the screens, press the right arrow <→> and the left arrow <←> keys.

Setting the Main Screen

The CMOS Main screen (Figure 4-2) is used to set the time and date, to set the floppy drive types, to configure IDE hard disks and to configure the video. This chapter explains how to configure each of these categories. To move between the categories, use the up and down arrow <↑/↓> keys.

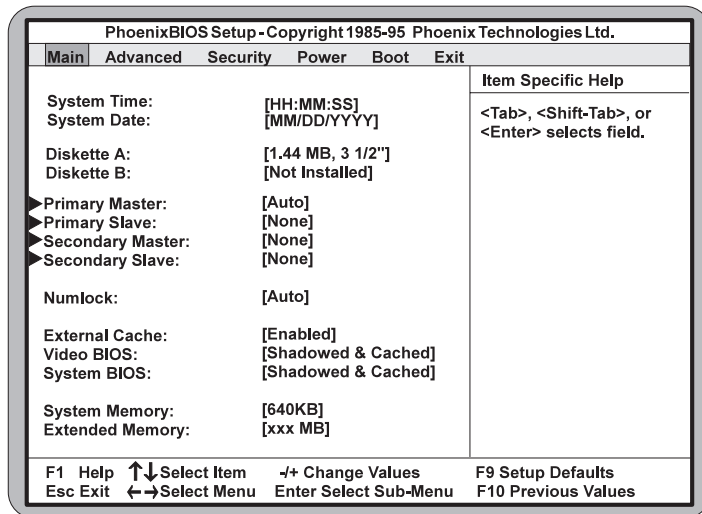

Figure 4-2: CMOS Main Screen

System Time and Date

To set the time, use the <-> key to decrease the number and the <+> key to increase the number. To move the prompt forward, use the <Tab> key; to move the prompt backward, use the <Shift-Tab> key. To set the date, use the up and down arrows <↑/↓> to highlight the System Date and follow the same procedure used to set the time.

Diskette A or B

To configure a floppy drive added to or removed from your computer, use the up and down arrow keys <↑/↓> to select the desired drive. Use the <+/-> keys to change the setting until it matches the floppy drive you installed. The BIOS supports 2.88MB, 1.44MB, 1.2MB, 720KB, and 360KB floppy drives.

Numlock

Setting this to ON activates Numlock upon boot. Setting this to Auto (default) activates Numlock if the BIOS detects a numeric keyboard. It may also be set to OFF.

External Cache

This selection allows you to enable the external memory cache. For optimal performance, select Enabled.

Video BIOS

The Video BIOS category allows you to Shadow or Shadow & Cache the video BIOS. Choosing Shadowed & Cached (default) caches the shadowed video BIOS for even higher performance. Choosing Shadowed copies the video BIOS into RAM for faster execution. To disable the Video BIOS category, select Disabled.

System BIOS

The System BIOS category allows you to Shadow or Shadow & Cache the system BIOS. Choosing Shadowed & Cached (default) caches the shadowed system BIOS for even higher performance. Choosing Shadowed copies the system BIOS into RAM for faster execution. To disable the System BIOS category, select Disabled.

System Memory

The System Memory category identifies the size of the base memory. It cannot be changed.

Extended Memory

The Extended Memory category automatically detects the amount of memory installed above the amount in the System Memory category. Because the BIOS automatically calculates the amount of memory installed in your system, you cannot change this category without adding or removing memory.

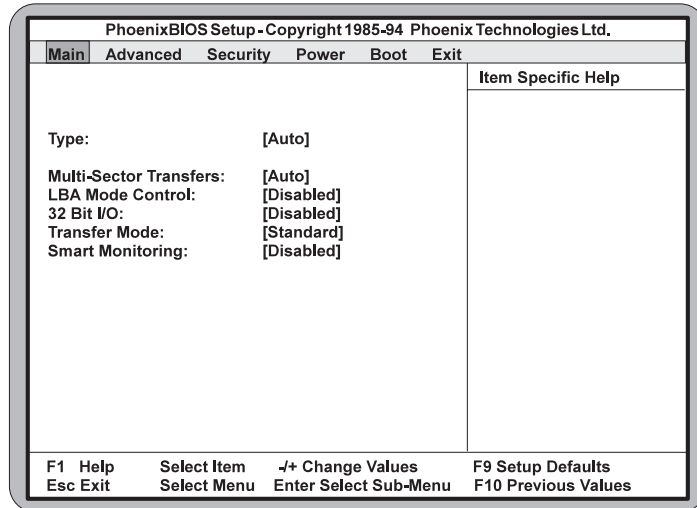

Figure 4-3: IDE Device Submenu

Type

This category selects the drive type installed in the system. The options are Auto (default), 1-39, User and None. If Autotype Fixed Disk does not find your drive's parameters, fill this information in manually under the User category. This information may be in the manual which came with your system. If not, contact your dealer or the hard drive manufacturer to fill in this category. If you are using a SCSI hard drive, select None and refer to the documentation which came with the SCSI adapter.

Multiple-Sector Transfers

This category determines the number of sectors per block for multiple sector transfers. The options are Disabled (default), 2 Sectors, 4 Sectors, 8 Sectors and 16 Sectors.

LBA Mode Control

Enabling this selection causes LBA (Logical Block Addressing) to be used in place of Cylinders, Heads and Sectors. The default setting is Disabled.

32-Bit I/O

This category allows you to enable the 32-bit I/O function of the PCI IDE controller. Select Disabled if your drive will not run at this speed. The default setting is Disabled.

Transfer Mode

This category sets the transfer speeds for IDE devices. The Standard option is the default setting. The Fast PIO 1, Fast PIO 2, Fast PIO 3 and Fast PIO 4 options are for higher speed devices.

Smart Monitoring

This feature will monitor your hard drive and report any problems detected. The default setting cannot be changed.

Setting the Advanced Screen

To move to the Advanced screen, use the left and right arrow keys <<-/> keys until you see the screen below.

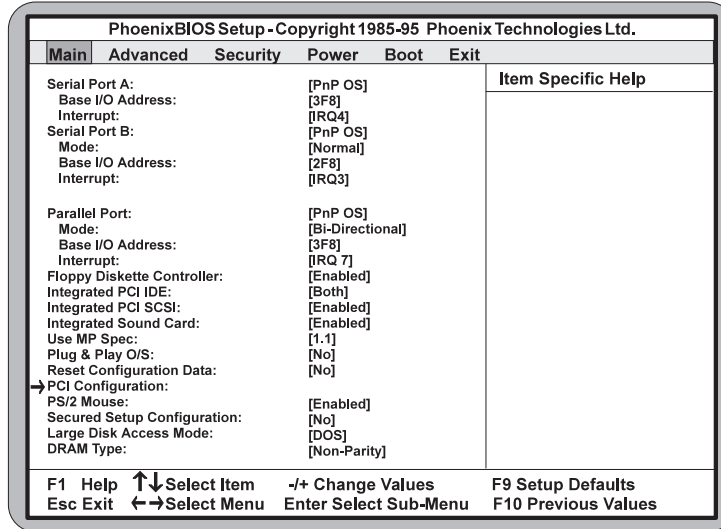

Figure 4-4: Advanced Screen

Serial Port A

Serial Port A may be configured using the following options: Disabled (No configuration), Enabled (User configuration), Auto (BIOS configuration) and PnP O/S (O/S configuration).

Serial Port B

Serial Port B may be configured using the following options: Disabled (No configuration), Enabled (User configuration), Auto (BIOS configuration) and PnP O/S (O/S configuration).

Parallel Port

The parallel port may be configured using the following options: Disabled (No configuration), Enabled (User configuration), Auto (BIOS configuration) and PnP O/S (O/S configuration).

Floppy Disk Controller

The selection allows you to enable or disable the floppy disk controller.

Integrated PCI IDE

Enables or disables the integrated Local Bus IDE adapter. The IDE controller may be set for Primary, Both (default) or Disabled.

Integrated SCSI

Enable or disable the integrated PCI SCSI interface. The default setting is Enabled.

Integrated Sound

Enables or disables the integrated sound interface. The default setting is Enabled.

Use MP Specification

This selection allows you to select the 1.1 (default) or 1.4 multiprocessor specification.

Plug & Play O/S

This selection, when set to Yes, allows the system to work with a Plug and Play operating system such as Windows 95. The default setting is No.

Reset Configuration Data

Select Yes to reset Extended System Configuration Data (ESCD) when you exit Setup. This selection allows the PnP BIOS to detect your PCI and ISA PnP devices and reallocate resources to them. The default setting is No.

PCI Configuration

Use this selection for additional setup menus to configure PCI devices.

PS/2 Mouse

When disabled, this selection prevents the PS/2 mouse from functioning and frees up IRQ12. Selecting Enabled (default) allows the operating system to determine whether to enable or disable the mouse.

Secured Setup Configuration

Select Yes if you want the system settings to be secured from change by a Plug and Play operating system. The default setting is No.

Large Disk Access Mode

If you are using a DOS operating system (MS-DOS, Novell DOS or PC-DOS), set to DOS (default). If you are using anything else, set to OTHER.

DRAM Type

The DRAM type can be set for Non-Parity (default), Parity or ECC. Selecting ECC will detect the parity error and allow the system to correct the error.

Security Screen

The Security screen controls access to the computer. The security screen allows for settings of two passwords. The Supervisor Password allows access to the system and Setup. The User Password allows access to the system, but not to all Setup features.

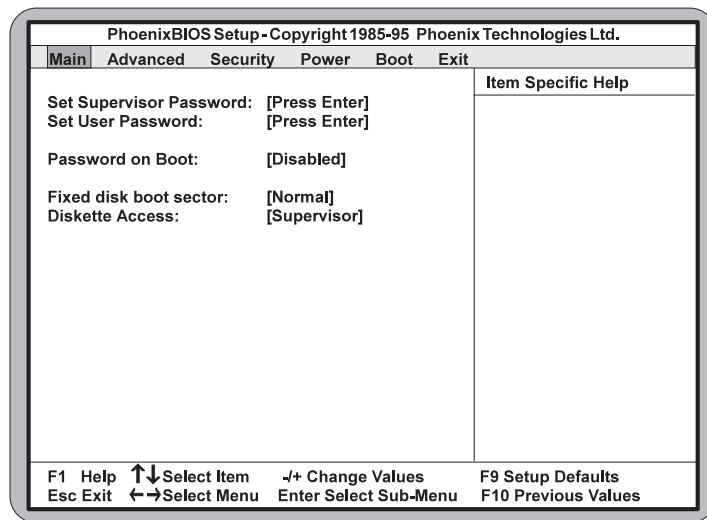

Figure 4-5: Security Setup Screen

Set Supervisor Password

This selection controls access to the Setup utility. Press the ENTER key to enter the Supervisor Password submenu. The screen on the following page appears.

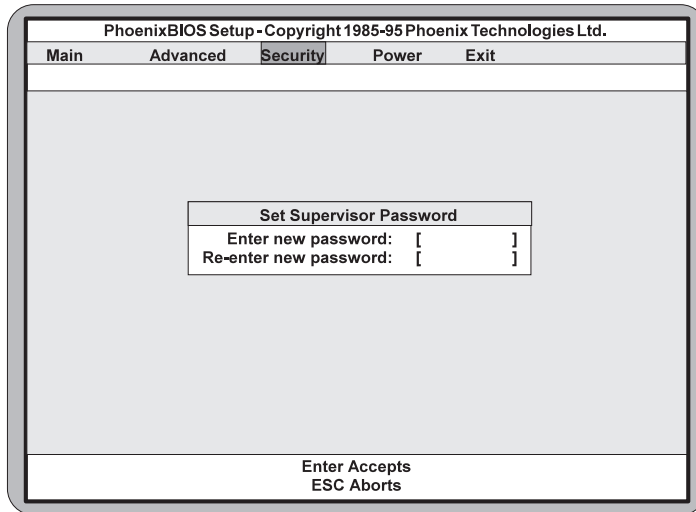

Figure 4-6: Supervisor Password Submenu

Type the password and press the ENTER key. Retype the password and press the ENTER key again. Write down the password somewhere safe so it will not be forgotten. The password may be disabled by setting the new password to nothing (pressing the ENTER key without first typing a password).

WARNING: If you forget the Supervisor Password, it cannot be disabled without discharging the CMOS.

Set User Password

This selection controls access to the Setup utility. Follow the same procedure used to set the Supervisor Password.

NOTE: After a password is entered, it is saved immediately. All other changes may still be discarded (see Exit Screen).

Password on Boot

When enabled, the system requires a password upon power up. Either the Supervisor or User Password may be entered.

Fixed Disk Boot Sector

This selection allows the boot sector of the fixed disk to be write protected. The default setting is Normal. When set for Write Protected, it serves as a form of virus protection. If the passwords are enabled, this option may only be changed by the supervisor.

Diskette Access

This selection allows floppy disk access with an option of the supervisor or user. Selecting Supervisor (default) gives floppy disk access to the supervisor only. Selecting User gives floppy disk access to both the user *and* the supervisor. If the passwords are enabled, this option may only be changed by the supervisor.

Power Screen

The Power Screen controls the power management functions of the system. To move to the Power Screen, use the left and right arrow <←/→> keys until it appears (Figure 4-7). To move between the categories, use the up and down arrow keys <↑/↓>.

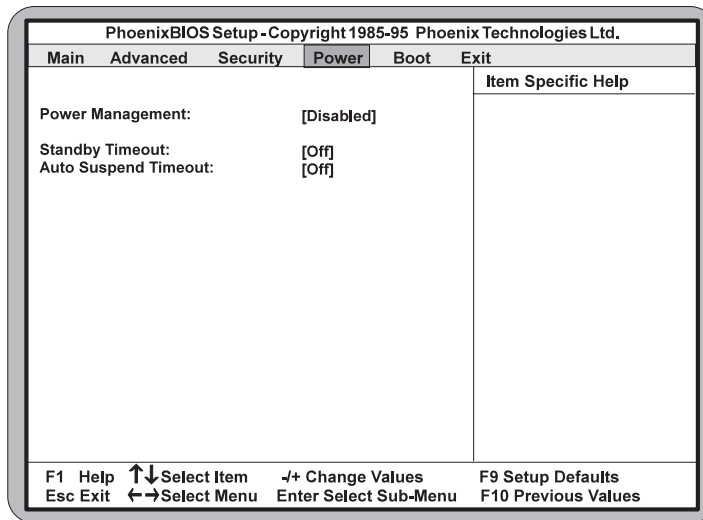

Figure 4-7: Power Screen

Power Management

This selection allows you to change the system power management settings. Maximum Power Savings conserves the greatest amount of system power. Maximum Performance conserves power but allows greatest system performance. To alter these settings, choose Customize. To turn off power management, choose Disabled (default).

Standby Timeout

The Standby Timeout selection sets the amount of time that elapses for the system to enter Standby Mode. Standby Mode turns off various devices in the system, including the display screen, until you start using the system again. The options are Off (default), 1 min., 2 min., 4 min., 6 min., 80 min., 12 min. or 16 min.

Auto Suspend Timeout

The Standby Timeout selection sets the amount of time that elapses for the system to enter Suspend Mode. The options are Off (default), 5 min., 10 min., 15 min., 20 min., 30 min., 40 min. or 60 min. Before making changes, "Customized" must be selected in the Power Management Mode selection.

Boot Screen

The Boot screen allows you to configure the power up system configuration settings.

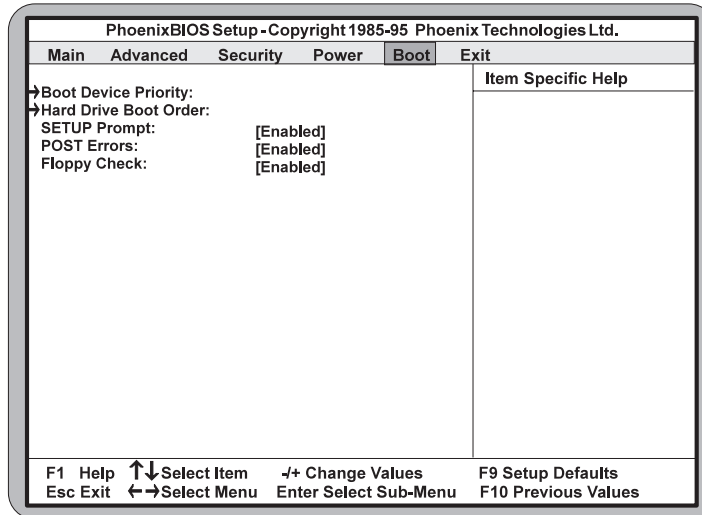

Figure 4-8: Boot Screen

Hard Drive Boot Order

This selection will read the diskette drive (default) and the hard drive in sequence on boot.

Setup Prompt

If this selection is enabled, the message "Press F2 to enter Setup" is displayed on boot. The default setting is Enabled.

POST Errors

If this selection is enabled (default) and an error occurs on boot, the BIOS will display a SETUP entry or resume prompt. If this selection is disabled, the system will always attempt to boot.

Floppy Check

This selection checks for the existence of a floppy drive. The default setting is Enabled.

Exit Screen

After you complete configuring the BIOS, select the Exit screen.

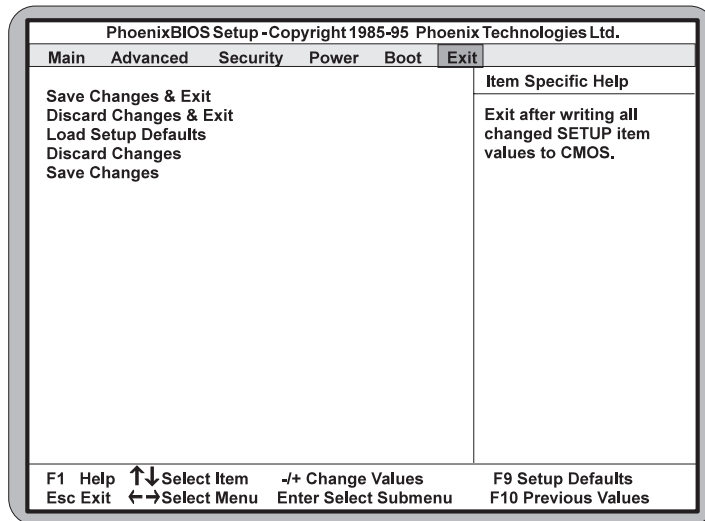

Figure 4-9: Exit Screen

Choose “Save Changes and Exit” and reboot the computer. Your computer is ready for use.

Installing Device Drivers

This chapter explains how to install the software device drivers and utilities necessary to utilize the optional sound and SCSI support. Other drivers and utilities are available through our online services.

About Device Drivers

Device drivers are necessary for the computer system to communicate with devices such as CD-ROM drives, sound controllers, graphics adapters or devices that are not natively supported by the system BIOS. Once started, device drivers remain active in the background of the computer system. Usually a device driver is added to the CONFIG.SYS file, the AUTOEXEC.BAT file or both.

Installing the Sound Drivers

Once you have connected your external sound devices, you can install the sound drivers. **NOTE:** If you are installing a CD-ROM drive, it is recommended you install it before setting up the sound devices. See *Installing a CD-ROM Drive* in Chapter 3.

1. Follow the instructions in Chapter 3 on connecting external sound devices.
2. If you previously installed another sound card, remove it and all associated files from your AUTOEXEC.BAT and CONFIG.SYS files. If you are using Windows 3.1x, you must also remove all associated files from the WIN.INI and SYSTEM.INI files. (For more information, please contact the sound driver manufacturer.)
3. Start your computer system.

Chapter 5: Installing Device Drivers

4. Insert the sound driver disk into your floppy drive.
5. If you are using Windows 3.1x, go to the Program Manager File menu, click on Run and type A:\SETUP
6. If you are using Windows 95, refer to the Windows 95 user's manual for instructions on how to install sound drivers.
7. If you are using OS/2, refer to the README file on the OS/2 disk for instructions on how to install sound drivers.
8. Once the software is copied, the install program automatically updates the system files.

Installing the SCSI Drivers

Refer to the "Adaptec 7800 Family Manager Set User's Guide" for information on installing and configuring drivers for your operating system.

Appendix ***Specifications***

A

Part Number:	09-00288
Processor:	Dual ZIF socket 8 Intel Pentium® Pro 150, 166, 180 and 200MHz processors. One integrated VRM and one VRM header to supply CPU-specific voltages.
Chipset:	Intel 440FX PCIset with PIIX 3 SMC FDC37C93X Ultra I/O chip
CPU Clock Select:	Frequency synthesizer chip Support for 60 and 66MHz CPU bus
Form Factor:	ATX extended footprint
Expansion:	Four 32-bit PCI slots Two 16-bit ISA slots (One shared PCI/ISA slot)
BIOS:	Phoenix 4.0X Plug and Play BIOS on 1MB Flash. Auto-detection of memory size Auto-detection and display of ECC and EDO memory. Auto-configuration of IDE hard disk types.
RAM Capacity:	Maximum memory - 512MB Four buffered 168-pin DIMM sockets Supports FPM and EDO DRAM memory. ECC supported via chipset when using parity.
Keyboard/Mouse:	PS/2 compatible

Appendix A: Technical Information

Onboard Sound:	Creative Labs VIBRA 16CL (optional)
Fast SCSI: (optional)	Adaptec 7880 Fast SCSI Bus Mastering controller Resident 50-pin SCSI connector Resident 68-pin SCSI connector (Ultra Wide SCSI).
Cache:	16K Level 1 Write Back on CPU chip 256K/512K Level 2 cache in CPU package
I/O Ports:	Two high speed serial ports (16550 compatible) Enhanced Parallel Port with ECP and EPP support Two USB connectors (optional)
Floppy Port:	Auto-detection and support of two floppy drives (2.88MB, 1.44MB, 1.2MB, 720K, 360K).
PCI IDE Ports:	Mode 4 IDE Two resident 40-pin IDE connector Multiple sector transfer support Auto detection of add-in IDE board

Environmental Specifications

The environment in which the W6-LI is located is critical. Micronics recommends the following environmental specifications:

Temperature Range

Operating: 50 to 104 degrees Fahrenheit (10 to 40 degrees Celsius).
Non -Operating: 50 to 140 degrees Fahrenheit (10 to 60 degrees Celsius).
Shipping: -22 to 140 degrees Fahrenheit (-30 to 60 degrees Celsius).

Relative Humidity

Operating: 20% to 80%.
Non-Operating: 5% to 90%.

Battery Disposal

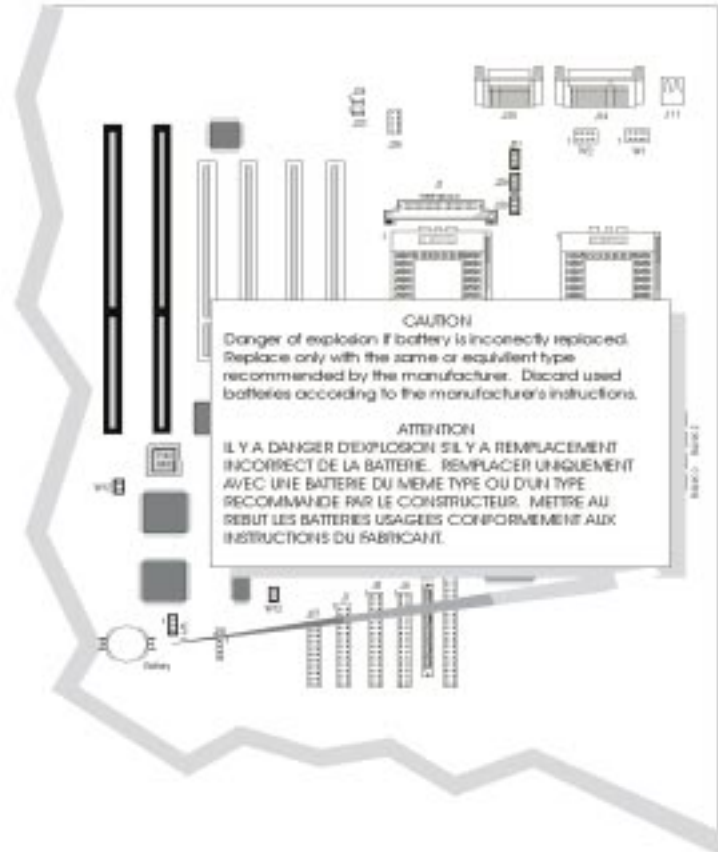

WARNING:

Please do not open battery, dispose of in fire, recharge, put in backwards or mix with used or other battery types. The battery may explode or leak and cause personal injury.

Support and Information Services

Micronics offers a variety of support and information services to help you get the most from your product. The following services are available:

- ▲ Technical Support
- ▲ Electronic Bulletin Board Service (BBS)
- ▲ Return Materials Authorization (RMA)
- ▲ Fax-On-Demand
- ▲ World Wide Web
- ▲ Customer Service

Refer to Table A-1 for details on these services.

Technical Support

If you need technical assistance, our Technical Support Engineers will be glad to help you. You can contact us via telephone, fax or BBS. Before calling Technical Support please have the following information ready:

- The model name and 09 part number of your Micronics product.
- Your computer information such as CPU type, operating system, amount of installed memory and other peripherals installed in your computer.
- Try to call from the location of your computer.

NOTE: For Return Material Authorization purposes, please keep a copy of your product receipt.

Appendix A: Technical Information

Service	Hours	Country	Telephone Number
Technical Support - Live phone help from Technical Support Engineers	M-F: 7:00am to 5:00pm (PST)	USA France UK	(510) 661-3000 (510) 651-6982 (Fax) +33 (1) 45 43 56 26 +33 (1) 45 43 17 78 (Fax) +44 (1256) 844899 +44 (1256) 364222 (Fax)
Electronic Bulletin Board Service (BBS) - Information on software upgrades, new releases and other helpful information	24 hours a day 7 days a week "	USA UK	(510) 651-6837 14400 baud rate, Parity=N, Data Bits=8, Stop Bits=1 YMODEM and ZMODEM (recommended file transfer protocols) +44 (1256) 363373
RMA (Return Materials Authorization) - Return products for repair	M-F: 8:00am to 4:45pm (PST)	USA	(510) 661-3030 (510) 683-0543 (Fax)
Fax-On-Demand - Automated system for product literature, technical bulletins and other helpful information	24 hours a day 7 days a week	USA	(510) 661-3199
World Wide Web - Product information, technical support, press releases and other helpful information	24 hours a day 7 days a week "	USA Europe	http://www.micronics.com http://www.mcrni.com
Customer Service - Order Micronics and Orchid products	M-F: 8:00am to 5:00pm (PST)	USA France UK Germany Taiwan	(800) 577-0977 (510) 651-3666 (Fax) +33 (1) 45 43 56 26 +33 (1) 45 43 17 78 (Fax) +44 (1256) 479 898 +44 (1256) 364222 (Fax) +49 (89) 58 09 82 55 +49 (89) 58 09 82 25 (Fax) +886 2 918 5005 +886 2 911 5472 (Fax)

Table A-1: Support and Information Services

Appendix A: Technical Information

Appendix ***POST Messages***

B

The following table lists the Power On Self Test (POST) messages, possible causes and solutions.

Message	Possible Cause	Solution
DISKETTE DRIVE A FAILURE	Drive A failed or is missing.	Check Setup and cable connections.
DISKETTE DRIVE B FAILURE	Drive B failed or is missing.	Check Setup and cable connections.
EXTENDED RAM FAILED AT OFFSET: nnnn	Extended memory not working or configured properly.	Replace defective memory.
FAILING BITS: nnnn	Memory failure in System, Extended, or Shadow memory.	Replace defective memory.
FIXED DISK X FAILURE (where X =0 or 1)	The hard disk is not configured or working properly.	Rerun SETUP and check connections, or replace hard disk.
FIXED DISK CONTROLLER FAILURE	The controller card has failed.	Check configuration and connections, or replace controller card.
INCORRECT DRIVE A TYPE	Floppy drive A: not set correctly in Setup.	Run Setup.
INCORRECT DRIVE B TYPE	Floppy drive A: not set correctly in Setup.	Run Setup.
INVALID NVRAM MEDIA TYPE	NVRAM chip is bad.	Requires repair of system board.
KEYBOARD ERROR, or KEYBOARD CONTROLLER ERROR	The keyboard or keyboard controller failed.	Check connections. You may have to replace the keyboard or controller.
KEYBOARD ERROR nn	A key is jammed or was held down during boot.	Make sure the keys are not jammed or dirty.
KEYBOARD LOCKED	Keyswitch on the front of the case is locked.	Unlock the keyswitch.

Appendix B: POST Messages

Message	Possible Cause	Solution
MONITOR TYPE DOES NOT MATCH CMOS	Monitor type not correctly identified in Setup.	Run Setup and enter correct monitor type.
OPERATING SYSTEM NOT FOUND	Operating system cannot be located on Drive C: or Drive A:	Check Setup to see if Drive A: and C: are properly configured, or put a bootable disk in Drive A:
PARITY CHECK 1 nnnn	Parity error found in the system bus.	Check Setup. Board repair may be required.
PARITY CHECK 2 nnnn	Parity error found in the I/O bus.	Check Setup. Board repair may be required.
PREVIOUS BOOT INCOMPLETE - DEFAULT CONFIGURATION USED	Previous POST did not complete successfully.	Run Setup, load default BIOS settings, make any necessary adjustments, and save the changes
REAL TIME CLOCK ERROR	Real-time clock failed BIOS test.	May require battery replacement or board repair.
SHADOW RAM FAILED AT OFFSET	Shadow RAM failed.	May require repair of system board.
SYSTEM BATTERY IS DEAD	System battery died.	Replace the system battery and run Setup to reconfigure the system.
SYSTEM CACHE ERROR - CACHE DISABLED	External (L2) cache failed BIOS test.	System will still run, but slower. Replace cache at convenience.
SYSTEM CMOS CHECKSUM BAD - RUN SETUP	System CMOS has been corrupted or modified incorrectly.	Run Setup and reconfigure the system.
SYSTEM RAM FAILED AT OFFSET: nnnn	System RAM failed.	Replace defective RAM.
SYSTEM TIMER ERROR	Timer test failed.	Requires repair of system board.

Beep and POST Codes

C

Beep codes are a series of beeps sent through the speaker which indicate a problem during the Power On Self Test (POST). If text appears on the video screen, the W6-LI has completed POST; any other tone from the speaker indicates something other than a POST error. These tones *are not* described in the tables on the following pages.

The beep error codes are a series of beeps. The duration of the beep tones are constant, but the length of the pauses between the beeps varies. For example: a 1-3-3 beep code will sound like one beep, a pause; three beeps consecutively, another pause and then three more beeps.

One beep code is often misunderstood. If a video card is not installed or is failing, the system board will generate a long-short-long-short beep code. This is often interpreted as a 1-2-1 beep code. But POST errors always vary in the length of the pause and not the duration of the beep tone.

Another way of identifying a POST error is to use a device called a POST card. This peripheral card is inserted into one of the ISA slots and has an LED (or LCD) read out showing the contents of port 80h.

The following tables list all beep codes and POST routines.

Appendix C: Beep and POST Codes

Code	Beeps	POST Routine Description
02		Verify Real Mode.
04		Get CPU type.
06		Initialize system hardware.
08		Initialize chipset registers with initial POST values.
09		Get in POST Reg.
0A		Initialize CPU registers.
0C		Initialize cache initial POST values.
0E		Initialize I/O.
0F		Initialize the localbus IDE.
10		Initialize Power Management.
11		Load alternate registers with initial POST values.
12		Jump to UserPatch0.
14		Initialize keyboard controller.
16	2-2-3	BIOS ROM checksum.
18		8254 timer initialization.
1A		8237 DMA controller initialization.
1C		Reset Programmable Interrupt Controller.
20	3-1-1	Test DRAM refresh.
22	3-1-3	Test 8742 Keyboard Controller.
24		Set ES segment register to 4 GB.
28		Autosize DRAM.
2A		Clear 512K base RAM.
2C	3-4-1	Test 512K base address lines.
2E	3-4-3	Test 512K base memory.
32		Test CPU bus-clock frequency.
34		Test CMOS RAM.
35		Initialize alternate chipset registers.
37		Reinitialize the chipset (MB only).
38		Shadow system BIOS ROM.
39		Reinitialize the cache (MB only).
3A		Autosize cache.
3C		Configure advanced chipset registers.
3D		Load alternate registers with CMOS values.
40		Set initial CPU speed.
42		Initialize interrupt vectors.
44		Initialize BIOS interrupts.
46	2-1-2-3	Check ROM copyright notice.
47		Initialize manager for PCI Option ROMs.
48		Check video configuration against CMOS.
49		Initialize PCI bus and devices.

Appendix C: Beep and POST Codes

Code	Beeps	POST Routine Description
4A		Initialize all video adapters in system.
4C		Shadow video BIOS ROM.
4E		Display copyright notice.
50		Display CPU type and speed.
51		Initialize EISA board.
52		Test keyboard.
54		Set key click if enabled.
56		Enable keyboard.
58	2-2-3-1	Test for unexpected interrupts.
5A		Display prompt "Press F2 to enter SETUP".
5C		Test RAM between 512 and 640k.
60		Test extended memory.
62		Test extended memory address lines.
64		Jump to UserPatch1.
66		Configure advanced cache registers.
68		Enable external and CPU caches.
6A		Display external cache size.
6C		Display shadow message.
6E		Display non-disposable segments.
70		Display error messages.
72		Check for configuration errors.
74		Test real-time clock.
76		Check for keyboard errors.
7C		Set up hardware interrupt vectors.
7E		Test coprocessor if present.
80		Disable onboard I/O ports.
82		Detect and install external RS232 ports.
84		Detect and install external parallel ports.
86		Re-initialize on-board I/O ports.
88		Initialize BIOSData Area.
8A		Initialize Extended BIOS Data Area.
8C		Initialize floppy controller.
90		Initialize hard-disk controller.
91		Initialize localbus hard-disk controller.
92		Jump to UserPatch2.
93		Build MPTABLE for multi-processor boards.
94		Disable A20 address line.
96		Clear huge ES segment register.
98		Search for option ROMs.
9A		Shadow option ROMs.

Appendix C: Beep and POST Codes

Code	Beeps	POST Routine Description
9C		Set up Power Management.
9E		Enable hardware interrupts.
A0		Set time of day.
A2		Check key lock.
A4		Initialize typematic rate.
A8		Erase F2 prompt.
AA		Scan for F2 keystroke.
AC		Enter SETUP.
AE		Clear in-POST flag.
B0		Check for errors.
B2		POST done - prepare to boot operating system.
B4		One beep.
B6		Check password (optional).
B8		Clear global descriptor table.
BC		Clear parity checkers.
BE		Clear screen (optional).
BF		Check virus and backup reminders.
C0		Try to boot with INT 19.
D0		Interrupt handler error.
D2		Unknown interrupt error.
D4		Pending Interrupt.
D6		Initialize option ROM error.
D8		Shutdown error.
DA		Extended Block Move.
DC		Shutdown 10 error.
		The following are for boot block in Flash ROM:
E2		Initialize the chipset.
E3		Initialize refresh counter.
E4		Check for Forced Flash.
E5		Check HW status of ROM.
E6		BIOS ROM is OK.
E7		Do a complete RAM test.
E8		Do OEM initialization.
E9		Initialize interrupt controller.
EA		Read in the bootstrap code.
EB		Initialize all vectors.
EC		Boot the Flash program.
ED		Initialize the boot device.
EE		Boot code was read OK.

Appendix **Hard Disk Drive Types**

D

The following table lists the IDE hard disk types supported by the W6-LI.

Type	Cylinders	Heads	Write Precomp	Sectors	Size
1	306	4	128	17	10
2	615	4	300	17	21
3	615	6	300	17	32
4	940	8	512	17	65
5	940	6	512	17	99
6	615	4	none	17	21
7	462	8	256	17	32
8	733	5	none	17	31
9	900	15	none	17	117
10	820	3	none	17	21
11	855	5	none	17	37
12	855	7	none	17	52
13	306	8	128	17	21
14	733	7	none	17	44
15	N/A	N/A	N/A	N/A	N/A
16	612	4	0	17	21
17	977	5	300	17	42
18	977	7	none	17	59
19	1024	7	512	17	62
20	733	5	300	17	31
21	733	7	300	17	94
22	733	5	300	17	31
23	306	4	0	17	10
24	612	4	305	17	21
25	612	2	300	17	10
26	614	4	none	17	21
27	820	6	none	17	42
28	977	5	none	17	42
29	1218	15	none	36	336
30	1224	15	none	17	159

Appendix D: Hard Disk Drive Types

Type	Cylinders	Heads	Write Precomp	Sectors	Size
31	823	10	512	17	71
32	809	6	128	17	42
33	830	7	none	17	50
34	830	10	none	17	72
35	1024	5	none	17	44
36	1024	8	none	17	71
37	615	8	128	17	42
38	1024	8	none	26	109
39	925	9	none	17	72

Appendix ***Updating the System BIOS***

E

The Micronics system boards are designed so that the BIOS can be reprogrammed using a BIOS file. You can easily FLASH a BIOS by following the steps below:

- 1) After downloading the appropriate BIOS file from our BBS or Website, extract it to a bootable MS-DOS 6.X diskette.
- 2) Reboot your system with the MS-DOS 6.X diskette in the A: drive. To make sure a clean DOS environment is loaded, press the F5 key while “Starting MS-DOS” is displayed. After the system has rebooted, the cursor will appear at the A:> prompt.
- 3) Now you can run the FLASH utility. The filename should be “PHLASH.EXE.” Type this filename at the A:> prompt (but don’t include its extension), followed by a space and the BIOS ROM image’s filename. This file will be included in the download and has a file length of about 131K or 262K. For example, to update the W6-LI to BIOS version 01, you would type:

```
PHLASH W6LI_01.ROM [ENTER]
```

- 4) After the update process has completed and the system reboots, verify that the new BIOS version appears on-screen. If you have problems during this process, or if you have questions about the procedure, please call Technical Support.

NOTE: If the BIOS is somehow erased or does not seem to accept the upgrade, you can purchase a new BIOS from MicroNiche Information Systems (800-733-9188). There is a \$30.00 fee plus shipping charges for this service. (Price and availability subject to change.)

If you prefer to send your system board in for the upgrade, the RMA department offers this service free of charge if your system board is under warranty.



If you encounter any problems during this process, or if you have questions about the procedure, please call Technical Support.

Appendix E: Updating the System BIOS

Appendix Limited Warranty

F

Except as described below, Micronics warrants the products to be free from defects in material and workmanship in normal use for a period of one (1) year from date of purchase. Should any product fail to perform according to this warranty at any time during the warranty period, except as provided below, Micronics or its authorized service centers will, at Micronics' option, repair or replace the product at no additional charge.

The warranty does not cover loss or damage which occurs in shipment or which is due to: (1) improper installation or maintenance, misuse, neglect or any cause other than ordinary commercial application, including without limitation, accidents or acts of God; (2) adjustment, repair, or modification by other than a Micronics authorized service center; (3) improper environment, excessive or inadequate heating or air conditioning, or electrical power failures, surges or other irregularities; (4) any statement about the product other than those set forth in this warranty; or (5) nonconformity to models or samples shown to the purchaser. Any models or samples were for the sole purpose of suggesting the character of the product and are not intended to form the basis of the bargain.

A receipt or copy of the invoice with the date of purchase from a Micronics reseller is required before any warranty service can be rendered. Service can be obtained by calling Micronics for a Return Merchandise Authorization (RMA) Number.

The RMA Number should be prominently displayed on the outside of the shipping carton of the returned product. Returned product should be shipped prepaid or hand carried to Micronics. The purchaser assumes risk of loss or damage in transit, and unless otherwise agreed to in writing by Micronics, will pay inbound shipping charges.

Appendix F: Warranties and Notices

The exclusive remedy of the purchaser under this warranty above will be repair or replace at Micronics' option, but if for any reason that remedy should fail of its essential purpose, the exclusive remedy of the purchaser shall then be actual damages up to amounts paid for the defective product by the purchaser. This limited warranty shall be deemed to "fail of its essential purpose" if, after repeated efforts, Micronics is unable to make the product operate as warranted. Micronics' liability for damages to the purchaser for any cause whatsoever; regardless of the form of action and whether in contract or in tort, shall be limited to the purchase price in effect when the cause of action arose for the product that is the basis of the claim.

Micronics will not be liable for any lost profits or any indirect, special incidental or consequential damages in connection with the product, even if Micronics has been advised of the possibility of such damages.

Micronics makes no warranties or representations as to performance of products or as to service to distributor or to any person, except as set forth in Micronics; limited warranty accompanying delivery of product.

Micronics disclaims all other warranties whether oral, written, expressed, or implied, including without limitation, the warranties of design, merchantability, or fitness for a particular purpose, if applicable, or arising from a course of dealing, usage or trade practice.

Non-Warranty Service

After the one year warranty service is no longer in effect, repair service is still available for Micronics products. For more information, contact Micronics' RMA department at (510) 661-3030. The RMA department is open between 8:30 A.M. and 4:45 P.M. Pacific Standard Time.

FCC Statement

This equipment has been tested and found to comply within the limits for a Class B digital device, pursuant to Part 15 of the FCC Rules. These limits are designed to provide reasonable protection against harmful interference in a residential installation. This equipment generates, uses and can radiate radio frequency energy and, if not used in accordance with the instructions, may cause harmful interference to radio communications. Interference to radio or television reception can be determined by turning the equipment off and on. You are encouraged to try to correct the interference by one or more of the following measures:

- ▲ Reorient the receiving antenna.
- ▲ Increase the separation between the equipment and the receiver.
- ▲ Connect the equipment into an outlet on a circuit different from that to which the receiver is connected.
- ▲ Consult your dealer or an experienced radio/TV technician for help.

To meet FCC requirements, shielded cables are required.

NOTE: Changes or modifications not expressly approved by Micronics could void your authority to operate the equipment.

Declaration of Conformity

Application of Council Directives 89/336/EEC. Standards to which the conformity is declared:

EN55022 EN50082-1

Manufacturer's Name: Micronics Computers, Inc.

Manufacturers Address: 221 Warren Avenue
Fremont, California 94539
USA
Telephone: (510) 651-2300
Fax: (510) 651-9450

Type of Equipment: Dual Pentium Pro Motherboard
(ATX Form Factor)
Full Tower Personal Computer

Model Name: W6-LI

Tested by: Micronics Computers, Inc.
221 Warren Avenue
Fremont, California 94539

Rockford Engineering Services, Inc.
9959 Calaveras Road, P.O. Box 543
Sunol, CA 94586-0543
Telephone: (510) 862-2944
Fax: (510) 862-9013

Test Engineers Peter Lam/Micronics (EN55022)
Joel Secoquian/RES (EN50082-1)

I, the undersigned, hereby declare that the specified equipment conforms to the directives and standards listed above.



Thomas Lui
Compliance Engineering Manager
August 15, 1996

Glossary

16550 UART - A high speed chip for controlling serial ports. Although unnecessary for a mouse, it is required for modems that are 14,400 baud or faster.

ATX - A system board size measuring approximately 12" x 9.6".

Asynchronous - Operations that do not require the clocks of communicating devices to be coordinated. See Synchronous.

Bidirectional Parallel Port - A type of parallel port that can send and receive information.

BIOS - An Acronym for Basic Input/Output System. Configures the system board and provides hardware information to the operating system.

Bit - A contraction of Binary digit. The smallest unit of information in a binary number system. A bit represents a choice between either zero or one.

Boot - To start up the computer and load the operating system software. See cold boot and warm boot.

Bus - A group of electronic paths used to send data between parts of the system. On a system board, the bus connects the peripheral cards with the microprocessor via the expansion slots.

Bus Mastering - The ability of a peripheral card to control the bus without requiring intervention of the CPU.

Byte - A group of adjacent bits treated as a unit. Eight bits are typically considered one byte. Also called a character.

Cache - A process where information is copied from the slower memory (DRAM) to the faster memory (SRAM). Information that is likely to be read or edited is stored in the cache providing significant performance increases.

Cache Hit - The percentage of request for data from memory that can be served from the cache.

Cache Miss - A memory access which cannot be supplied from cache.

Cold Boot - Starting the computer by turning on the power or pressing the RESET button. A cold boot makes the processor execute all of the diagnostics. See boot and warm boot.

CPU - An acronym for Central Processing Unit. A CPU performs arithmetic calculations, makes logical decisions, and directs the operation of the computer in conjunction with the operating system.

DIMM - An acronym for Dual Inline Memory Module. A small printed circuit board containing memory chips.

Disk Drive - A hardware device which provides for the storage of data on diskettes or hard metal disks that have a magnetic coating. A disk drive functions by spinning at high speed while moving a device called the

Glossary

read/write head across the disk's surface in order to read or write data in magnetic code.

DRAM - An acronym for Dynamic Random Access Memory. A type of memory chip that only keeps its memory if supplied with regular clock pulses and a chance to regularly refresh its data. It is slower and more cost effective than SRAM. See SRAM.

ECC - An acronym for Error Checking and Correction. ECC enables parity checking and can detect and correct memory errors on the system board.

ECP - An acronym for Expanded Capabilities Port. A standard set by Hewlett Packard and Microsoft Corporation to expand the capabilities of the parallel port.

EDO Memory - An acronym for Extended Data Out. A type of DRAM with built-in cache for enhanced performance.

EISA - An acronym for Extended Industry Standard Architecture. EISA is a bus design standard which is fully backward compatible with the ISA bus. Although it is a 32-bit bus, it only runs at 8MHz. See *PCI, VESA Local Bus and ISA*.

EPP - An acronym for Enhanced Parallel Port. A standard which increases the capabilities of the parallel port.

EPROM - Acronym for Erasable Programmable Read Only Memory. A

type of ROM chip that can be programmed with relatively simple tools that will retain its data until erased. It can only be erased by exposing the circuitry in the chip to ultraviolet light. See also Flash ROM.

Fast SCSI - A SCSI data transfer rate standard that allows a rate of up to 10MBytes/sec on an 8-bit SCSI bus and up to 20MBytes/sec on a 16-bit (Wide) SCSI bus.

Flash ROM - A type of ROM chip that will retain its data until erased. It can be erased or reprogrammed by supplying it with +12V of voltage. See ROM and EPROM.

Gigabyte - A disk storage capacity measurement. Approximately one thousand megabytes or 1,073,741,824 bytes.

IDE - An acronym for Integrated Device Electronics. A standard for communicating between a hard drive and a computer.

Internal Cache - Cache which is built into the CPU. See Cache.

ISA - An acronym for Industry Standard Architecture. A well-established bus standard that originated with the IBM AT. See *PCI, VESA Local Bus and EISA*.

Parallel - A form of data transmission in which the data is sent one byte at a time over several wires that each carry one byte. In parallel transmission, all

the bytes arrive simultaneously, as opposed to serial transmission in which bits arrive one by one.

Parallel Port - A connection for a printer or similar peripheral. Generally, parallel ports are output only. See Bidirectional Parallel Port and ECP.

PCI - An acronym for Peripheral Component Interconnect. A high performance 32-bit or 64-bit bus developed by Intel Corporation. PCI is designed to be independent of the hardware architecture to ensure compatibility with future computer systems. See *EISA*, *VESA Local Bus* and *ISA*.

Pentium - A high performance 64-bit CISC processor designed and manufactured by Intel Corporation.

Plug and Play - A standard developed to ensure easy installation of peripherals. Theoretically, a newly installed card will automatically configure itself and work properly without requiring jumper configuration or device drivers.

POST - An acronym for Power On Self Test. A diagnostic program that is run whenever the system is cold booted.

RAM - An acronym for Random Access Memory. A type of memory that is used as the “working memory” of a computer system. See DRAM and SRAM.

ROM - An acronym for Read Only Memory. A type of memory that retains its data without requiring power. Once written, it cannot be modified. See EPROM and Flash ROM.

SCSI - Small computer system interface. A bus interface standard that defines physical and electrical characteristics for hardware devices. SCSI provides a standard interface that enables many different kinds of devices, such as disk drives and CD-ROM drives to interface with the host computer.

Serial - A type of data transmission in which the data is sent one bit at a time over a single wire. See Parallel.

Serial Port - A communications port used to connect peripherals such as modems and mice.

Setup - A program that allows you to make changes to the system configuration.

Shadow RAM - A technique used to load a duplicate copy of BIOS from slower ROM into faster RAM. This enhances system performance because it provides higher access speed to the BIOS.

Small Computer System Interface - See SCSI.

SRAM - An acronym for Static Random Access Memory. A type of memory that can retain data without requiring a regular clock signal.

Glossary

Although they are faster than DRAM, they hold less data and are more expensive.

Synchronous - Protocols that require the clocks of communicating machines or devices to be coordinated.

Synchronous Cache - A type of cache that uses a clock signal to latch the inputs and the data output. This structure spreads the cache access across two or three cycles while maintaining a bandwidth of one access per cycle. Improves performance by 5-10%.

Terabyte - A measurement for very large storage capacity. One Terabyte is equivalent one-thousand gigabytes, one-million megabytes, or 1,099,511,627,766 bytes.

VESA - An acronym for Video Electronics and Standards Association.

VESA Local Bus (VL-Bus) - A high performance bus designed by VESA. A 32-bit version of the ISA bus which operates at the speed of the computer's CPU. See *PCI, EISA and ISA*.

VID - Voltage Identification. A hardware mechanism used by the CPU to tell its power regulator what voltage to set.

VRM - Voltage Regulator Module. Supplies CPU specific voltages for the Secondary CPU.

Warm Boot - Restarting the system by simultaneously pressing the <Ctrl>, <Alt> and <Delete> keys.

Wide SCSI - A SCSI-2 enhancement that allows data to be transferred 16 or 32 bits at a time on the SCSI bus instead of 8 bits at a time.

Write-Back Cache - Upon a cache hit, the cache is updated and the main memory is not affected. Upon a cache miss, only the main memory is updated.

Write-Through Cache - Upon a cache hit, the cache and the main memory are updated. Upon a cache miss, only the main memory is updated.

Index

A

- ATX
 - Chassis - 18
 - Form Factor - 5
 - Power Supply - 18

B

- Back Panel Connections - 12
- Battery Disposal - 55
- Beep and POST Codes - 61
- BIOS
 - Configuration - 33
 - Setup - 33
- Bulletin Board System (BBS) - 55

C

- Configuring the W6-LI - 11
- Connecting
 - SCSI Option - 32
 - Sound Option - 30
 - Telephony Option - 31

D

- Diagram (W6-LI) - 12

E

- Extended Data Out (EDO) Memory - 17, 19

Index

Environmental Specifications - 54
Error Checking (ECC) - 17

F

Fast Page Mode (FPM) Memory - 17, 19

H

Hard Disk Drive Types - 65
Help
 Bulletin Board System (BBS) - 57
 Telephone Numbers - 57
 Troubleshooting - 61

I

Installation
 CD-ROM Drive - 29
 CPU - 26
 Installing your W6-LI - 17
 ISA Peripheral Card - 28
 PCI Peripheral Card - 27
 Quick Installation - 9
 SCSI Drivers - 52
 Sound Drivers - 51

J

Jumper Settings - 13

M

W6-LI Back Panel Connections - 12

W6-LI System Board Diagram - 12

Memory

Configurations - 21

Adding Memory - 19

Installing - 25

Removing - 25

Supported - 17, 19

O

Online Services - 57

P

POST Messages - 61

S

SCSI Option - 32

Sound Option - 30

Specifications - 53

System BIOS - 67

T

Technical Specifications - 53

Technical Support - 56

Telephony Option - 31

Troubleshooting - 61

Index

U

- Updating the System BIOS - 67
- Utility Programs
 - Advanced Screen - 40
 - BIOS Setup - 33
 - Boot Screen - 48
 - Exit Screen - 49
 - IDE Device Submenu - 44
 - Main Screen - 35
 - Power Screen - 46
 - Security Screen - 43

W

- World Wide Web - 55